

**Agenzia del Territorio
CATASTO FABBRICATI
Ufficio Provinciale di
Udine**

Dichiarazione protocollo n. UD0273778 del 29/07/2009

Planimetria di u.i.u. in Comune di San Vito Al Torre

Via Udine

civ.

Identificativi Catastali:

Sezione: A
Foglio: 4
Particella: 66/13
Subalterno: 6

Compilata da:
Simoni Danilo

Iscritto all'albo:
Geometri

Prov. Gorizia

N. 221

Scheda n. 1

Scala 1:200

PIANTA PIANO INTERRATO
H=2.40 m.

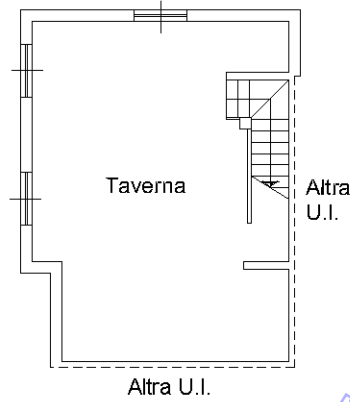

PIANTA PIANO TERRA
H=2.55 m.

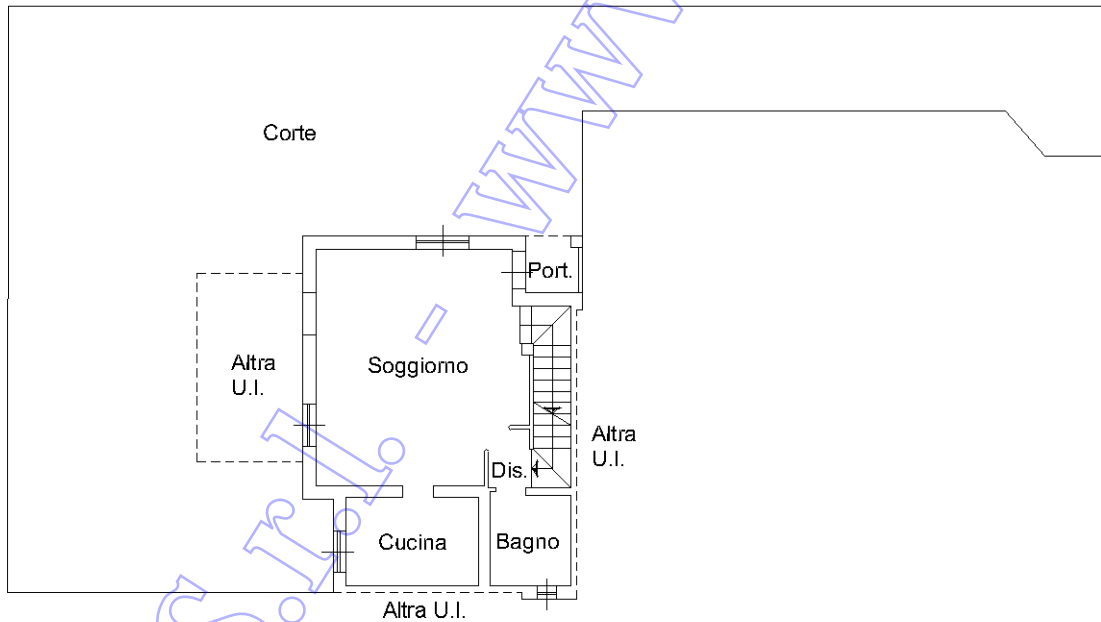

PIANTA PIANO PRIMO
H=2.55 m.

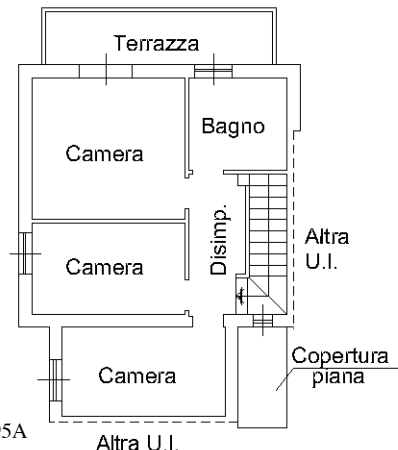

Ultima planimetria in atti



NORD

**Agenzia del Territorio
CATASTO FABBRICATI
Ufficio Provinciale di
Udine**

Dichiarazione protocollo n. UD0273778 del 29/07/2009

Planimetria di u.i.u. in Comune di San Vito Al Torre

Via Udine

civ.

Identificativi Catastali:

Sezione: A

Foglio: 4

Particella: 66/13

Subalterno: 12

Compilata da:
Simoni Danilo

Iscritto all'albo:
Geometri

Prov. Gorizia

N. 221

Scheda n. 1

Scala 1:200

PIANTA PIANO TERRA

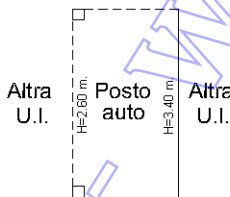

Coveg S.r.l.

www.ivgoudine.it

Ultima planimetria in atti



NORD

ELABORATO PLANIMETRICO

Compilato da:
Simoni Danilo

Iscritto all'albo:
Geometri

Prov. Gorizia N. 221

**Agenzia del Territorio
CATASTO FABBRICATI
Ufficio Provinciale di
Udine**

Comune di San Vito Al Torre

Sezione: A Foglio: 4 Particella: 66/13

Protocollo n. UD0273778 del 29/07/2009

Tipo Mappale n. 268537 del 24/07/2009

Dimostrazione grafica dei subalterni

Scala 1 : 500

PIANO INTERRATO

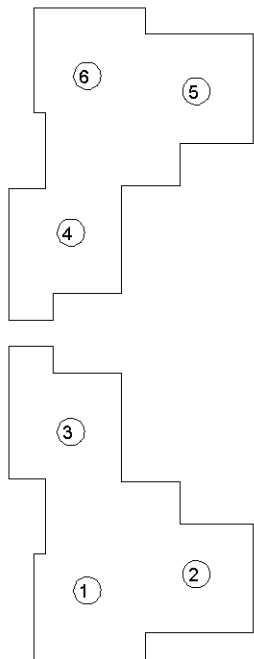

PIANO TERRA

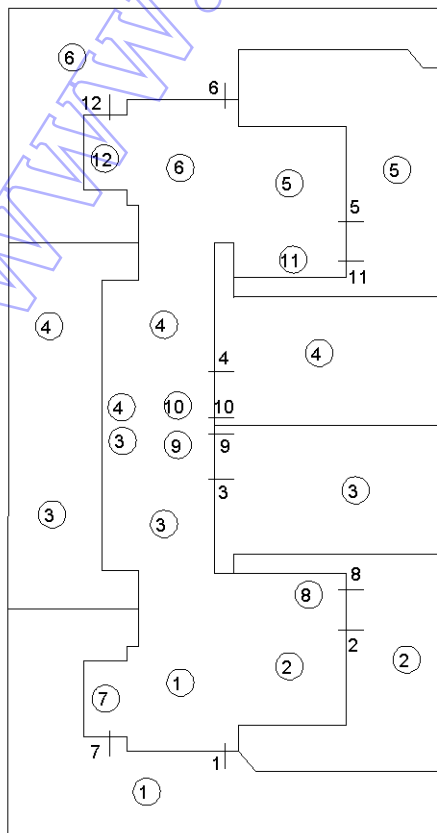

PIANO PRIMO

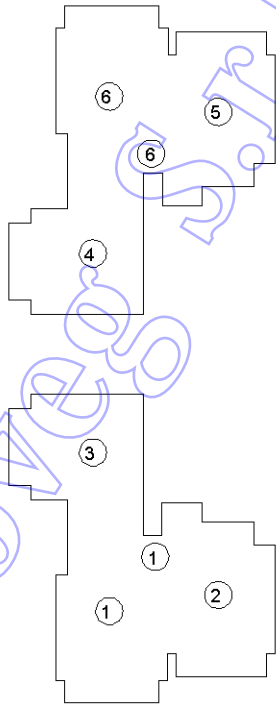

Planimetria non attuale



FOTO AEREA
LOTTO 01

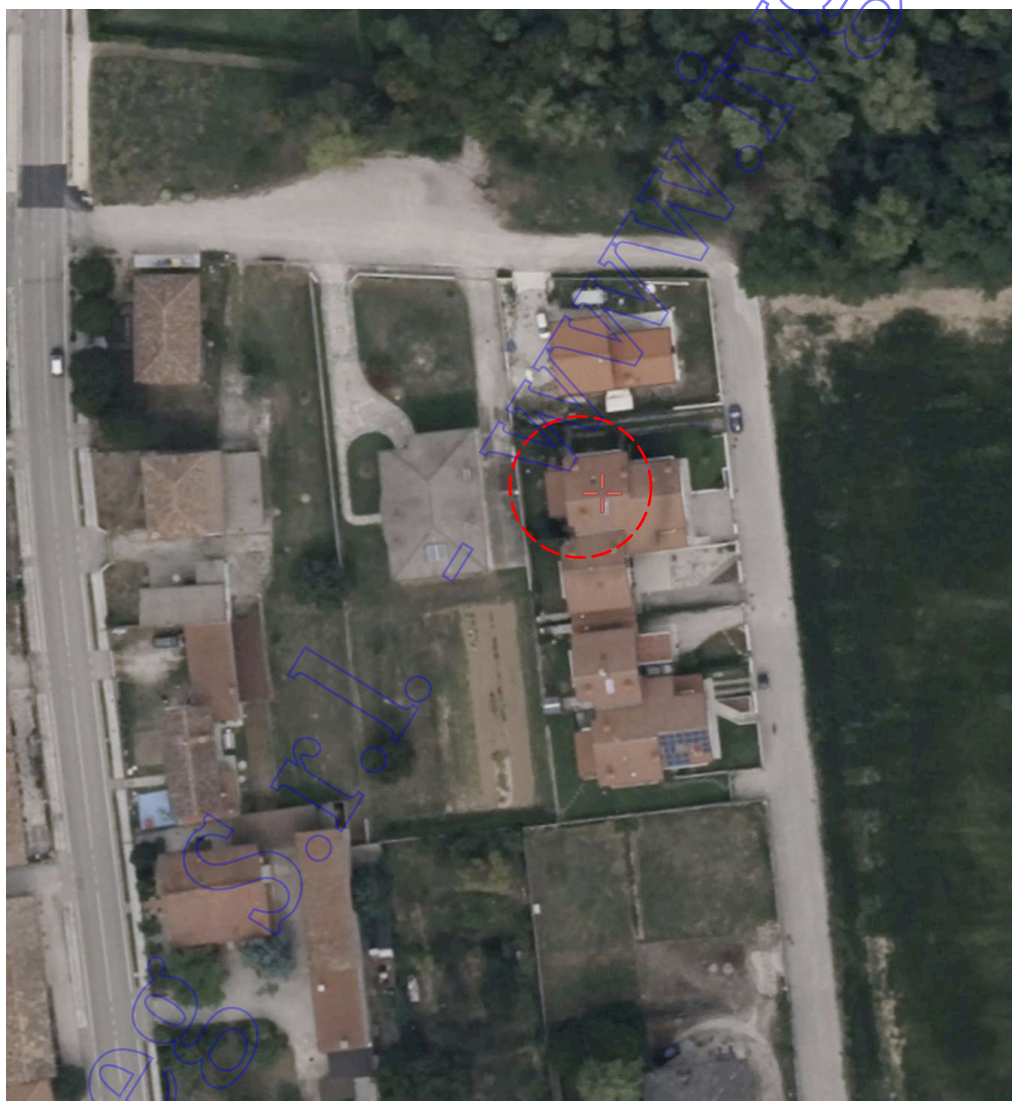

Coves S.r.l.

**DOCUMENTAZIONE
FOTOGRAFICA
LOTTO 01-sub.1**
prospetti fotografici
unità immobiliare residenziale



Coveo

**DOCUMENTAZIONE
FOTOGRAFICA
LOTTO 01-sub.1**
prospetti fotografici
unità immobiliare residenziale



Coveos S.p.A.

www.coveos.it

**DOCUMENTAZIONE
FOTOGRAFICA
LOTTO 01**
prospetti fotografici
unità immobiliare residenziale



Coveo S.r.l.

**DOCUMENTAZIONE
FOTOGRAFICA
LOTTO 01**
prospetti fotografici
locali interni zona giorno PT



Coveo S.r.l.

**DOCUMENTAZIONE
FOTOGRAFICA
LOTTO 01**
prospetti fotografici locali
interni servizio PT e scantinato



Coveo S.r.l.

**DOCUMENTAZIONE
FOTOGRAFICA
LOTTO 01**
prospetti fotografici
locali interni zona notte P1

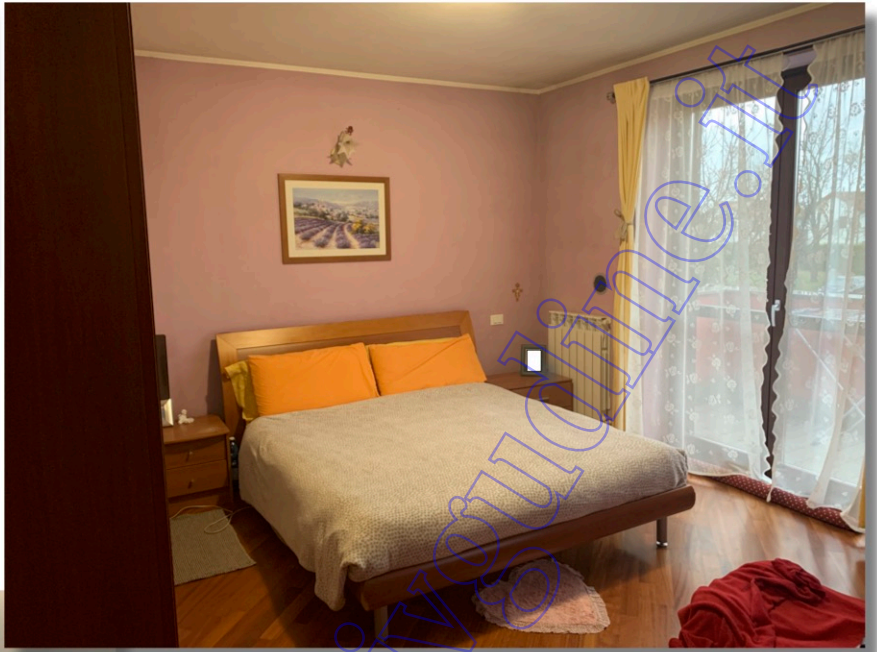

Coveo Srl

**DOCUMENTAZIONE
FOTOGRAFICA
LOTTO 01**
prospetti fotografici
locali interni zona notte P1



Coveos S.r.l.