

**Agenzia delle Entrate
CATASTO FABBRICATI
Ufficio Provinciale di
Foggia**

ELABORATO PLANIMETRICO	
Compilato da: Santagata Vincenzo	
Iscritto all'albo: Geometri	
Prov. Lucera	N. 1161

Comune di Torremaggiore	Protocollo n. FG0150330 del 01/09/2023
Sezione: Foglio: 42 Particella: 549	Tipo Mappale n. del

Dimostrazione grafica dei subalterni Scala 1 : 500

PRIMO PIANO SOTTOSTRADA

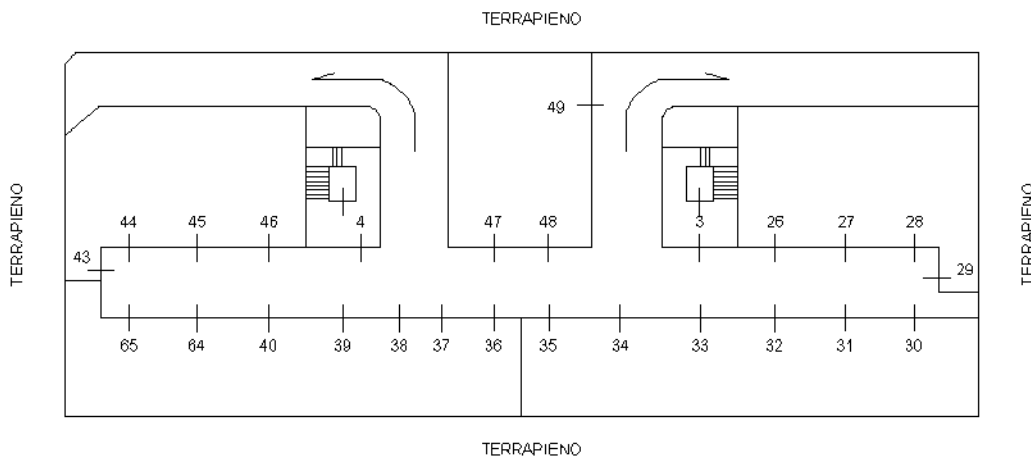

PIANO TERRA

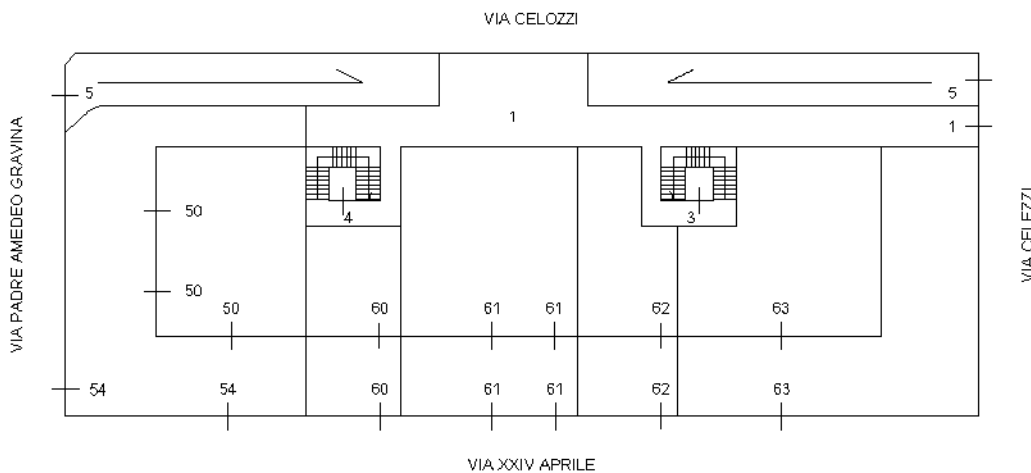

PIANO PRIMO

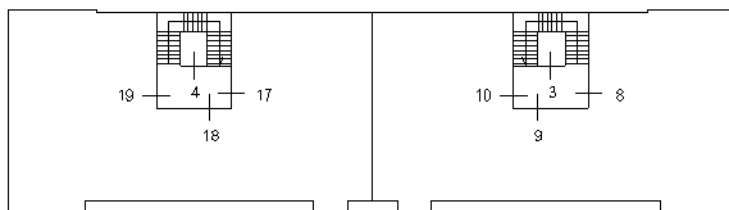

IL TECNICO
geom. Vincenzo SANTAGATA

Elaborato Planimetrico - Catasto dei Fabbricati - Situazione al 20/05/2025 - Comune di TORREMAGGIORE(L273) - < Foglio 42 Particella 549 >

Ultima planimetria in atti

**Agenzia delle Entrate
CATASTO FABBRICATI
Ufficio Provinciale di
Foggia**

ELABORATO PLANIMETRICO	
Compilato da: Santagata Vincenzo	
Iscritto all'albo: Geometri	
Prov. Lucera	N. 1161

Comune di Torremaggiore	Protocollo n. FG0150330 del 01/09/2023
Sezione: Foglio: 42 Particella: 549	Tipo Mappale n. del

Dimostrazione grafica dei subalterni Scala 1 : 500

PIANO SECONDO

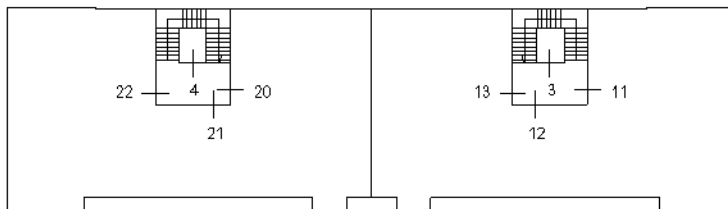

PIANO TERZO

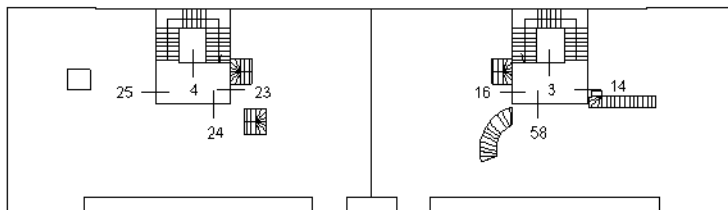

PIANO SOTTOTETTO

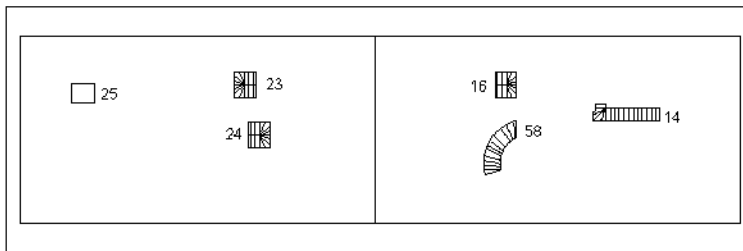

IL TECNICO
geom. Vincenzo SANTAGATA

Ultima planimetria in atti

Dichiarazione protocollo n. 000065052 del 18/03/2002

**Agenzia del Territorio
CATASTO FABBRICATI
Ufficio Provinciale di
Foggia**

Planimetria di u.i.u. in Comune di Torremaggiore

Via 25 Aprile

civ. CN

Identificativi Catastali:

Sezione:

Foglio: 42

Particella: 549

Subalterno: 34

Compilata da:

Landella Giuseppe

Iscritto all'albo:

Geometri

Prov. Lucera

N. 1065

Scheda n. 1

Scala 1:200

PIANTA PIANO INTERRATO

H. = 3.00 ml.

Sup. = mq. 40,00

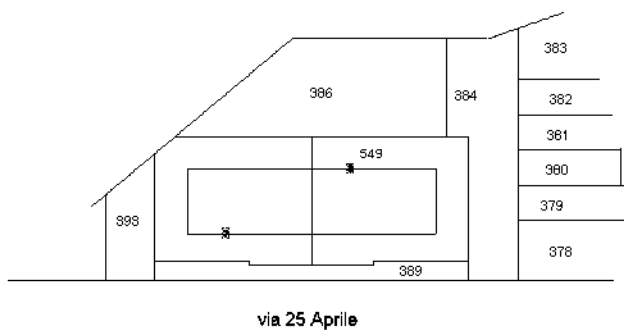
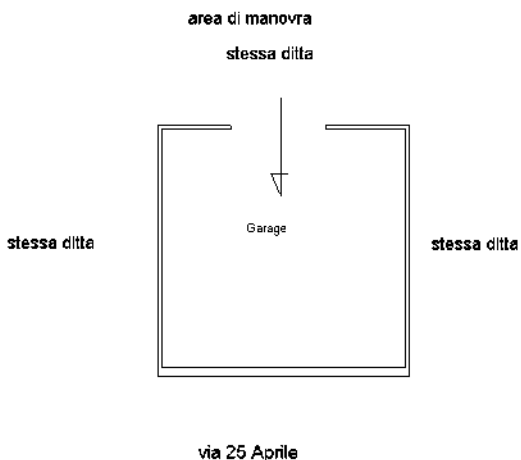

Ultima planimetria in atti

ALLEGATO F

Rilievo planimetrico (*Foglio 42, Particella 549, Sub 16*);

Rilievo planimetrico (*Foglio 42, Particella 549, Sub 34*);

PIANTA PIANO TERZO

ABITAZIONE A/3

Foglio 42 Particella 549 Sub 16

H = 2,70 M

Via Ingegner F. Celozzi

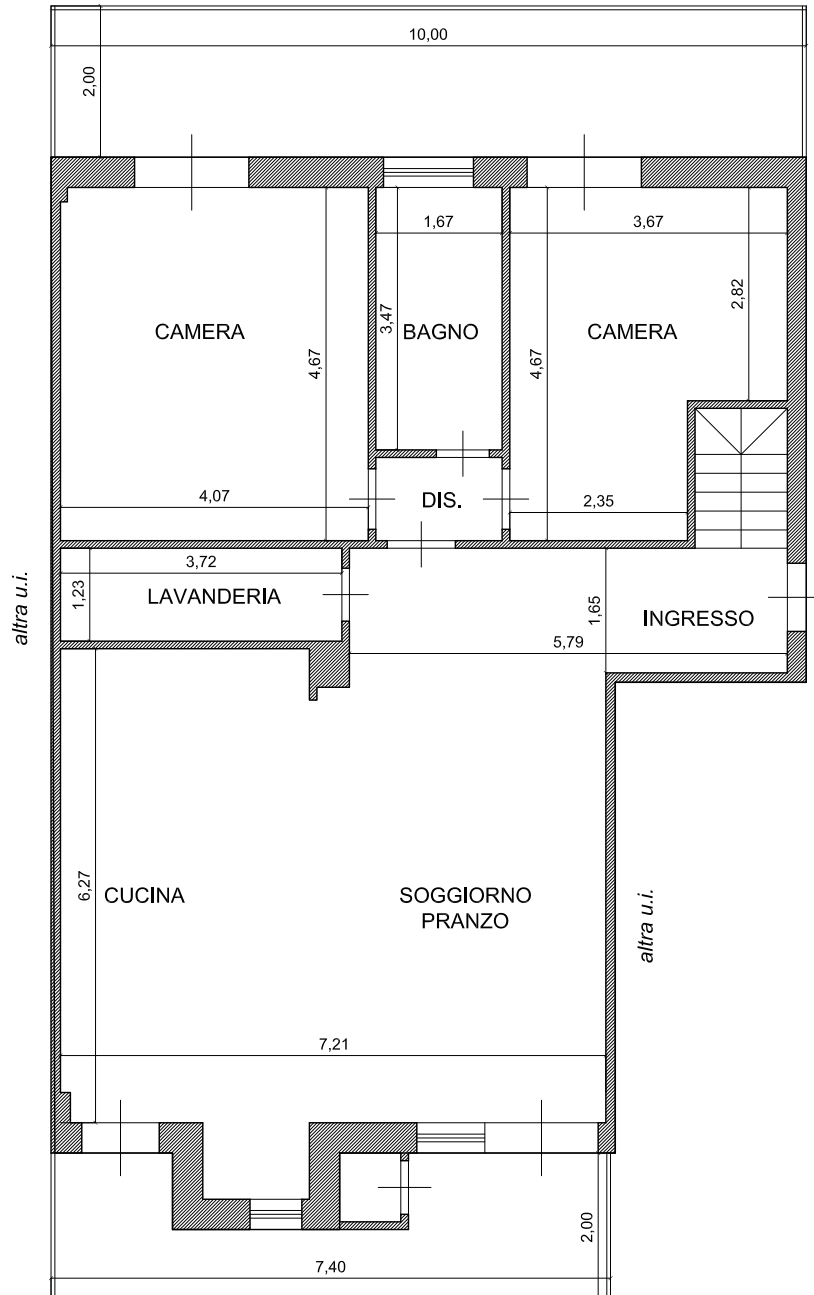

Via XXV Aprile

PIANTA PIANO QUARTO

ABITAZIONE A/3

Foglio 42 Particella 549 Sub 16

Hmedia = 1,70 M

Via Ingegn F. Celozzi

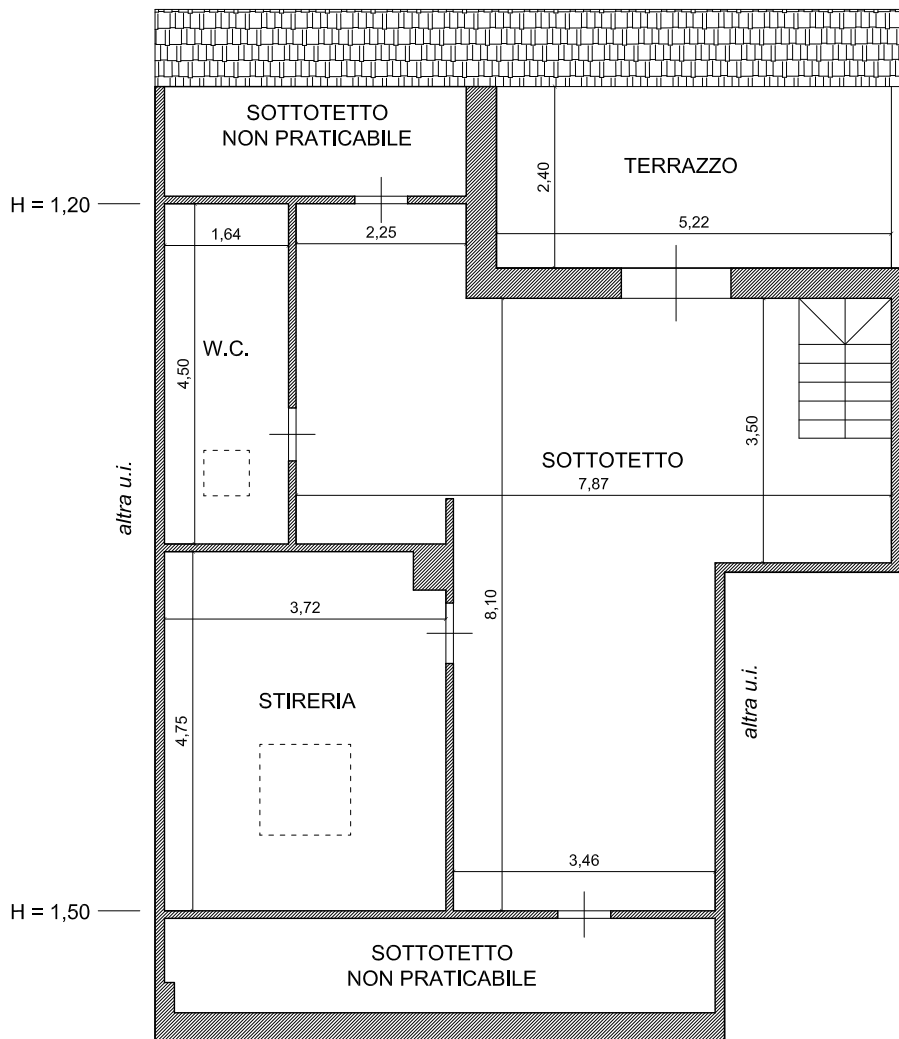

Via XXV Aprile

PIANTA PIANO INTERRATO AUTORIMESSA C/6

Foglio 42 Particella 549 Sub 34

H = 3,05 M

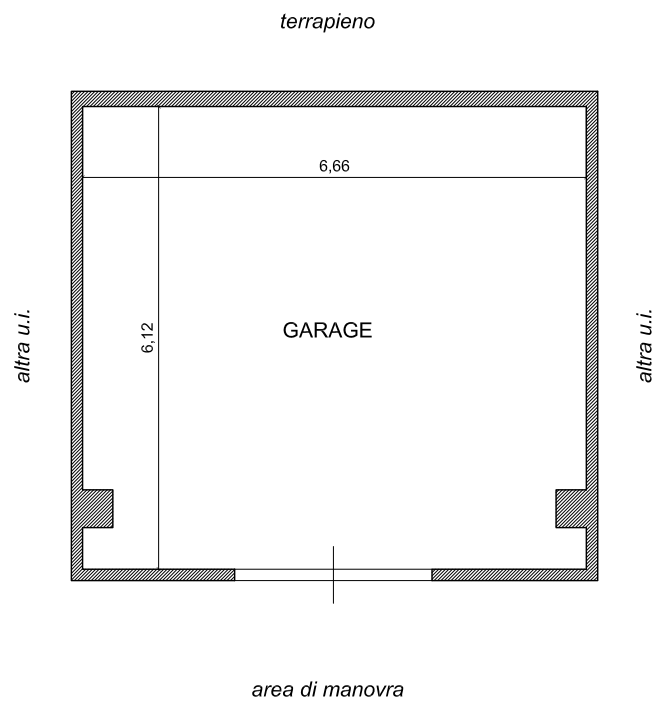

ALLEGATO G

Allegato fotografico n.33 fotografie;













