

Planimetria stato di fatto
Pianta Piano Terra
h= 2.80 mt

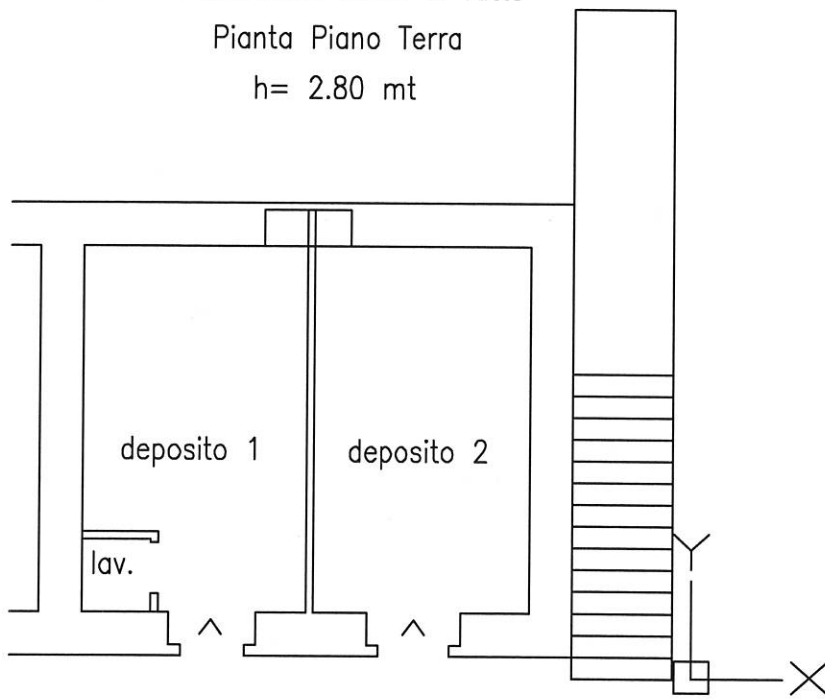

1/100

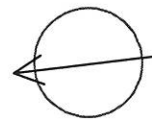

Planimetria quotata stato di fatto

Pianta Piano Terra

h= 2.80 mt

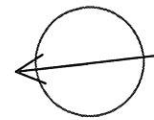
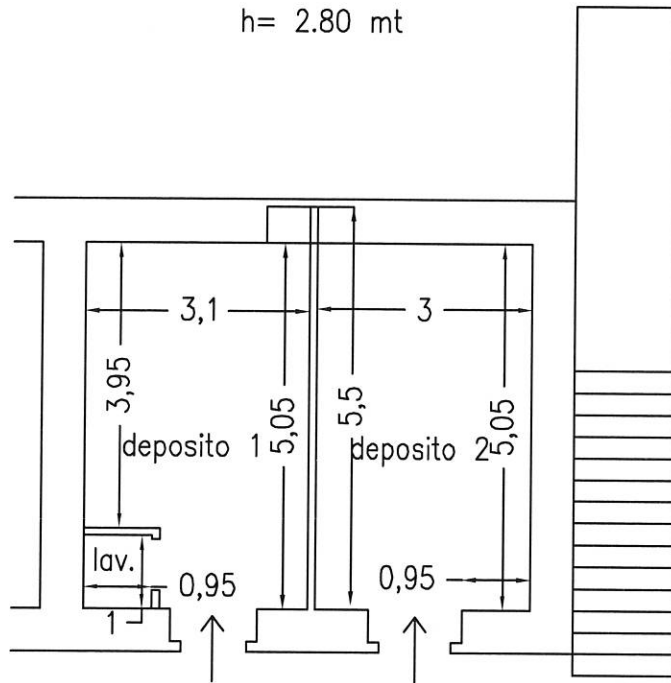

Planimetria stato di fatto con indicazioni superfici

Pianta Piano Terra

h= 2.80 mt

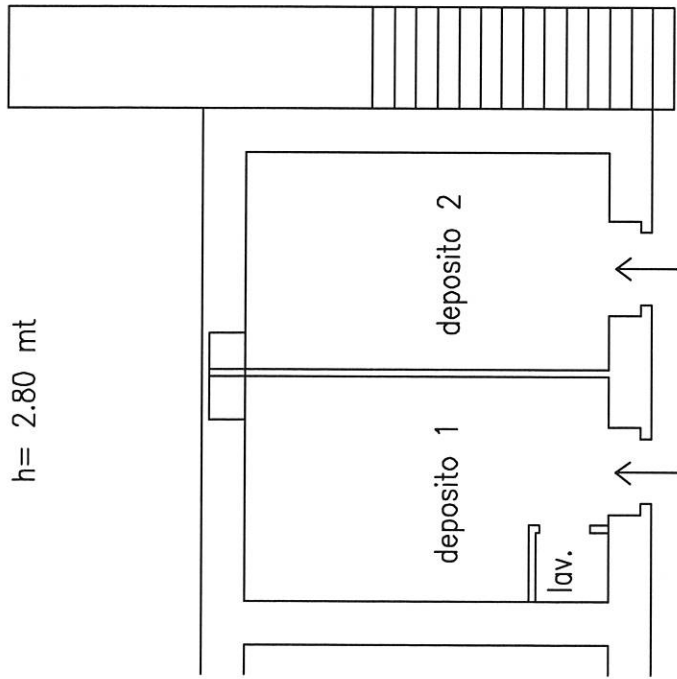

superficie utile deposito 1 mq 15,65
superficie utile deposito 2 mq 15,00
superficie lorda in c.t. mq 46,00
superficie commerciale in c.t. mq 46,00

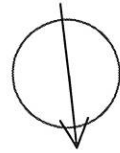

Planimetria stato di fatto con indicazioni difformità

Pianta Piano Terra

h= 2.80 mt

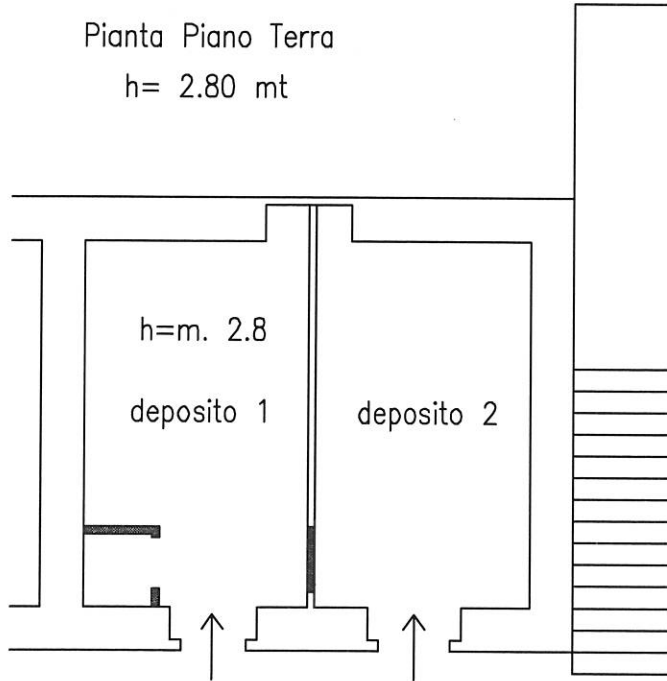

Difformità



1/100

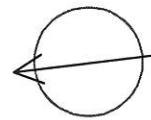

Planimetria stato di fatto
Pianta Piano primo
h= 2.70 mt

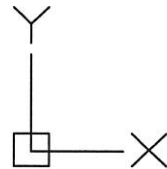
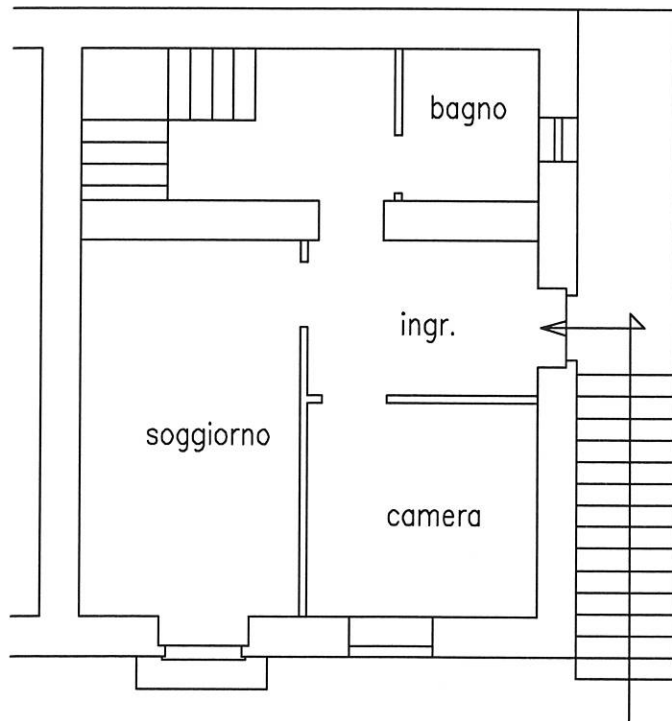

1/100

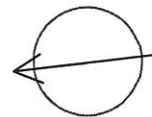

Planimetria quotata stato di fatto
Pianta Piano primo
h= 2.70 mt

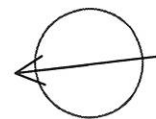
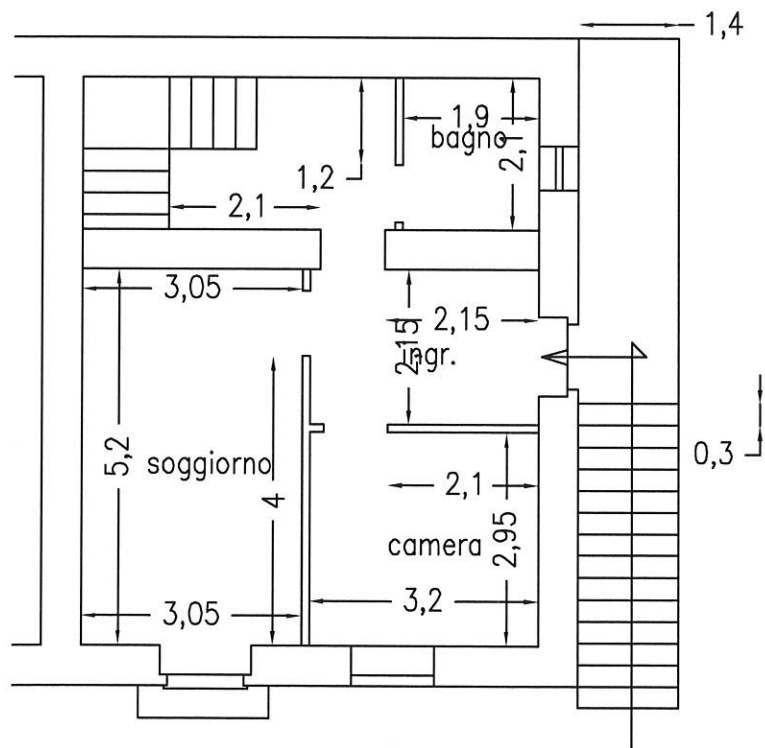

Planimetria stato di fatto con indicazioni superfici

Pianta Piano primo

h= 2.70 mt

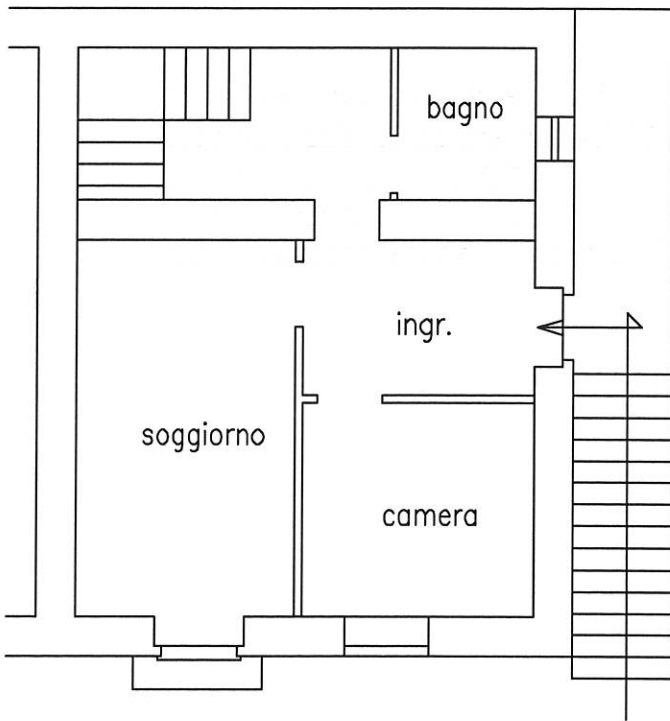

superficie lorda abitazione mq 64.60
superficie utile abitazione mq 42.00
superficie balcone mq 0.80
superficie ballatoio mq 7.20
superficie commerciale in c.t. mq 67

1/100

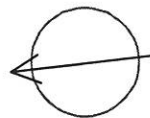

Planimetria stato di fatto con indicazioni difformità

Pianta Piano primo

h= 2.80 mt

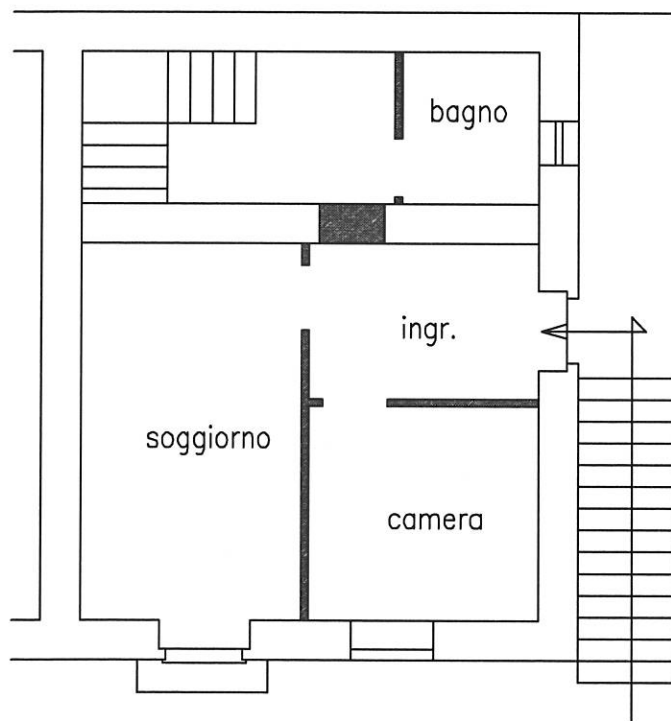

 Difformità riscontrate

1/100

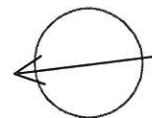

Planimetria stato di fatto
Pianta Piano Secondo
h= 2.80 mt

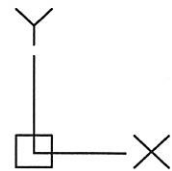
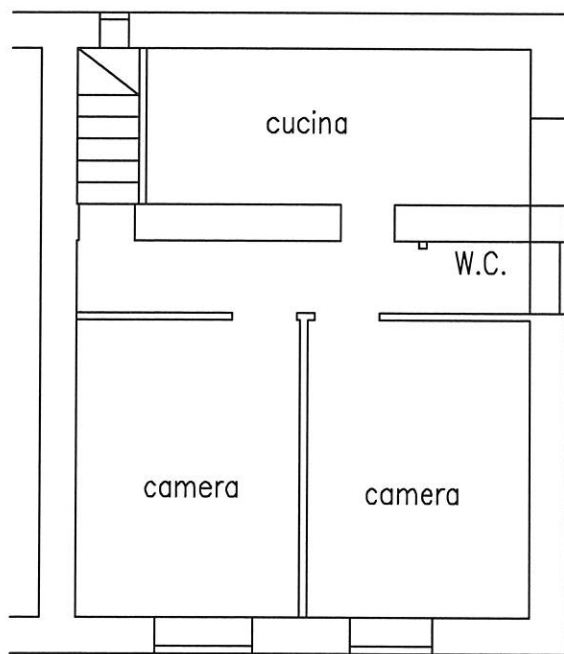

1/100

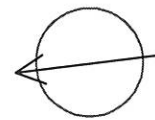

Planimetria quotata stato di fatto
Pianta Piano Secondo
h= 2.80 mt

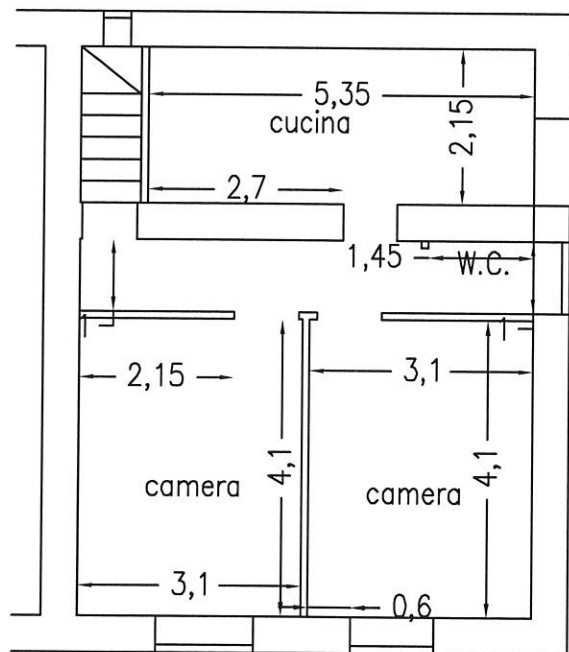

1/100

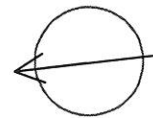

Planimetria stato di fatto con indicazioni superfici

Pianta Piano Secondo

h= 2.80 mt

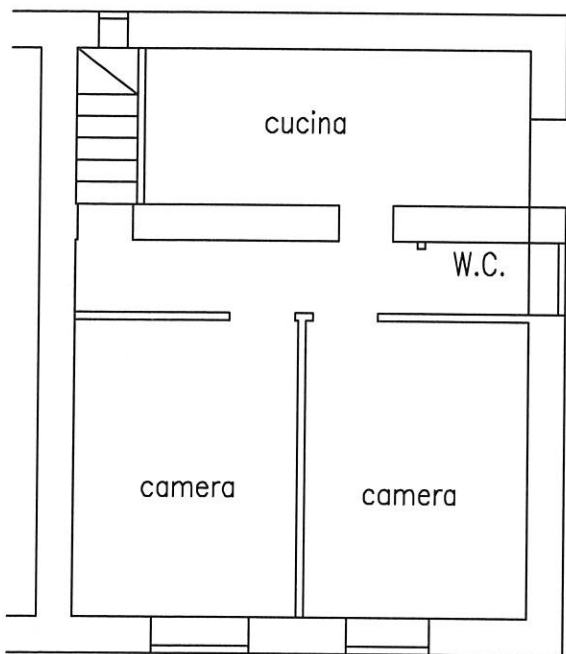

superficie lorda abitazione mq 64.60 mq
superficie utile abitazione mq 43.00
superficie commerciale in c.t. mq 65.00

1/100

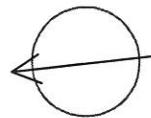

Planimetria stato di fatto con indicazioni difformità

Pianta Piano Secondo

h= 2.80 mt

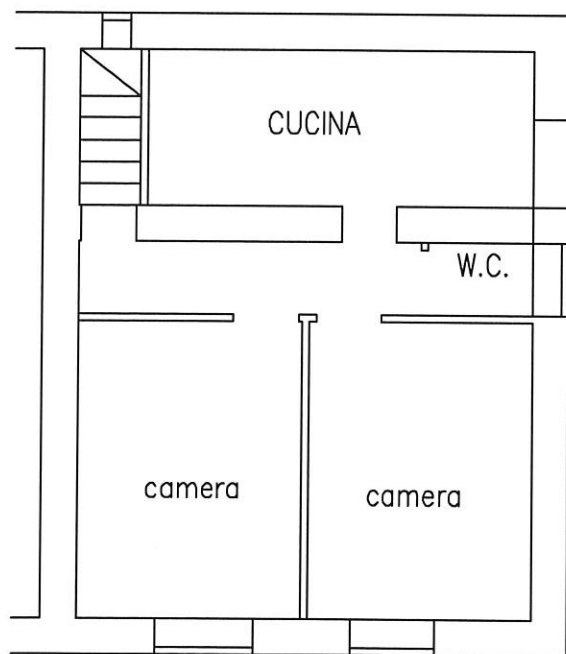

 Difformità riscontrate

1/100

