

<b>ELABORATO PLANIMETRICO</b>	Compilato da: <b>Giacomini Roberto</b>	Iscritto all'albo: <b>Geometri</b>	Prov. <b>Treviso</b>	N. <b>2076</b>
Comune di <b>Treviso</b>	Sezione: <b>C</b>	Foglio: <b>6</b>	Particella n. <b>TV0168350</b>	Protocollo n. <b>del 11/07/2025</b>
Dimostrazione grafica dei subalterni				
Tipo Mappale n. <b>218677</b> del <b>14/03/2003</b> Scala <b>1 : 500</b>				

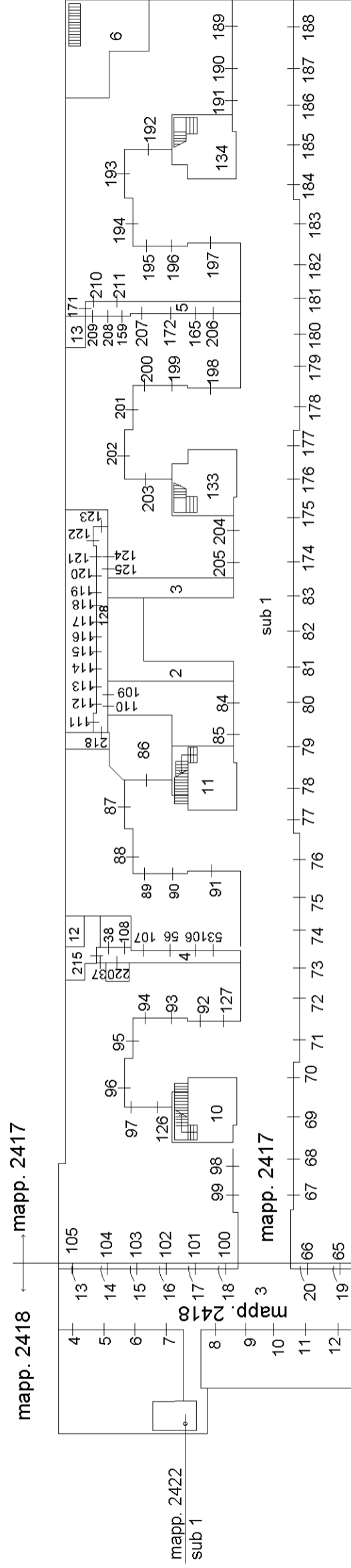

**PRIMO PIANO SOTTOSTRADA**

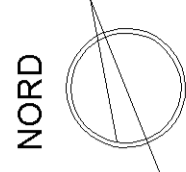

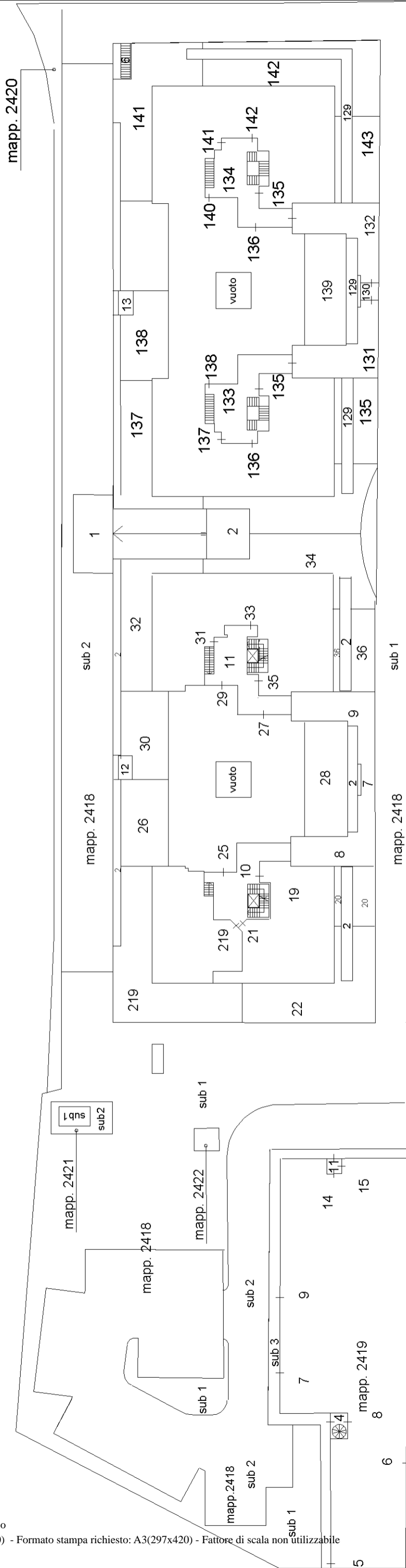

**PIANO TERRA CON AREE SCOPERTE**

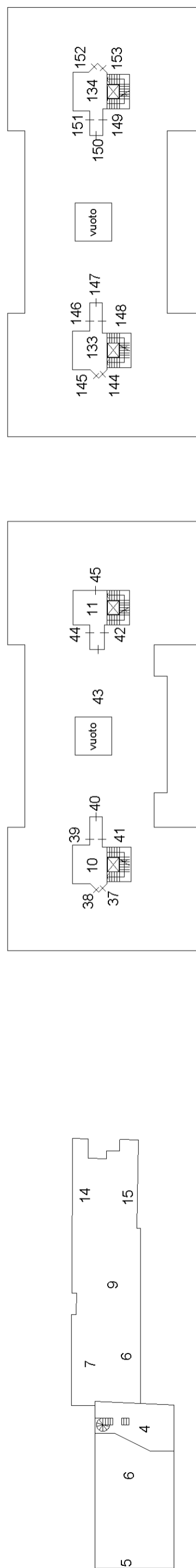

NORD

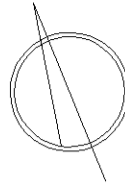

**PIANO PRIMO**

<b>ELABORATO PLANIMETRICO</b>	Compilato da: <b>Giacomini Roberto</b>	Iscritto all'albo: <b>Geometri</b>	Prov. <b>Treviso</b>	N. <b>2076</b>
Comune di <b>Treviso</b>	Sezione: <b>C</b>	Foglio: <b>6</b>	Particella: <b>2417</b>	Protocollo n. <b>TV0168350</b> del <b>11/07/2025</b>
Dimostrazione grafica dei subalterni				
Tipo Mappale n. <b>218677</b> del <b>14/03/2003</b> Scala <b>1 : 500</b>				

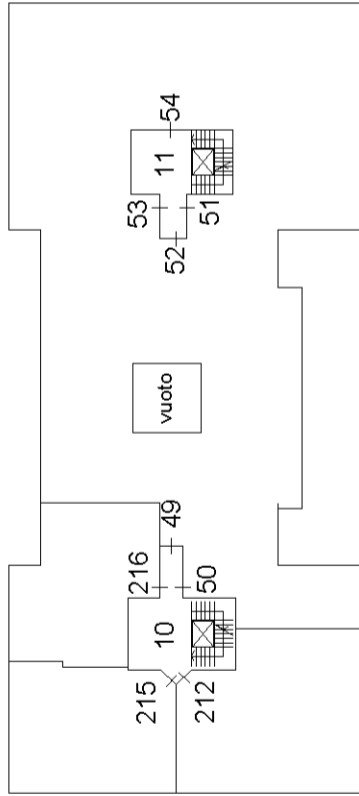

**PIANO SECONDO**

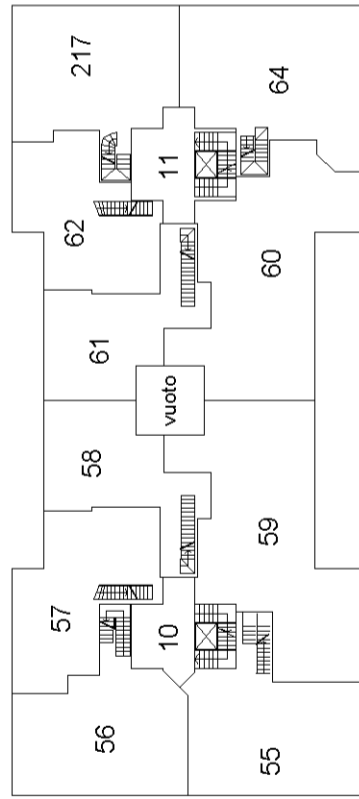

**PIANO TERZO**

