

RILIEVI DELLO STATO DI FATTO

FABBRICATO SITO IN CAMPAGNA (SA) VIA CALLI – FOGLIO 77 PART. 1055

ELENCO IMMOBILI:

PIANO TERRA

1-SUB 1

CORPO A

2-SUB 2

3-SUB 3

4-SUB 5

5-SUB 6

6-SUB 7

7-SUB 8

8-SUB 9

CORPO B

9-SUB 11

10-SUB 12

11-SUB 73

12-SUB 14

13-SUB 15

14-SUB 16

15-SUB 17

16-SUB 18

17-SUB 19

18-SUB 20

19-SUB 21

20-SUB 22

21-SUB 24

22-SUB 25

23-SUB 26

24-SUB 27

CORPO C

25-SUB 28

26-SUB 29

27-SUB 35

28-SUB 36

29-SUB 31

30-SUB 74

31-SUB 75

32-SUB 76

PIANO INTERRATO BOX AUTO

33-SUB 38

34-SUB 39

35-SUB 40

36-SUB 41

37-SUB 42

38-SUB 43

39-SUB 45

40-SUB 46

41-SUB 47

42-SUB 48

43-SUB 49

44-SUB 50

45-SUB 51

46-SUB 52

47-SUB 53

48-SUB 54

49-SUB 55

50-SUB 56

51-SUB 57

52-SUB 58

53-SUB 59

54-SUB 60

55-SUB 61

56-SUB 62

57-SUB 64

RILIEVI DELLO STATO DI FATTO

FABBRICATO SITO IN CAMPAGNA (SA) VIA CALLI – FOGLIO 77 PART. 1055

ELENCO IMMOBILI:

PIANO TERRA

1-SUB 1



SCHEDA IMMOBILE											
N.	SOPRALLUOGO	DATA	SCALA	PIANO	SUB	CAT	RAPP.	SUP. NETTA	SUP. BALC.	SUP. OMI	SUP. Omq
1	9	26.04.23	/	T	1	C/1	1:100	1.061,45 mq	/	1148,64 mq	1118,13 mq



RILIEVI DELLO STATO DI FATTO

FABBRICATO SITO IN CAMPAGNA (SA) VIA CALLI – FOGLIO 77 PART. 1055

ELENCO IMMOBILI:

CORPO A

2-SUB 2

3-SUB 3

4-SUB 5

5-SUB 6

6-SUB 7

7-SUB 8

8-SUB 9

TRIBUNALE DI SALERNO - 3° SEZIONE CIVILE - E.I. N.
 260/2022 STATO DI FATTO - Proprietà (Omissis)
 Comune di Campagna (SA) - Via Calli - Corpo A - Piano 1°
 Catasto Fabbricati - Foglio 77 part 1055 sub 2

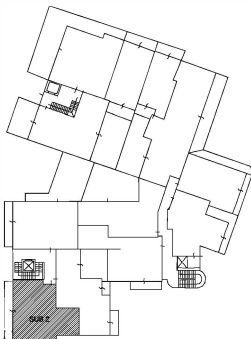
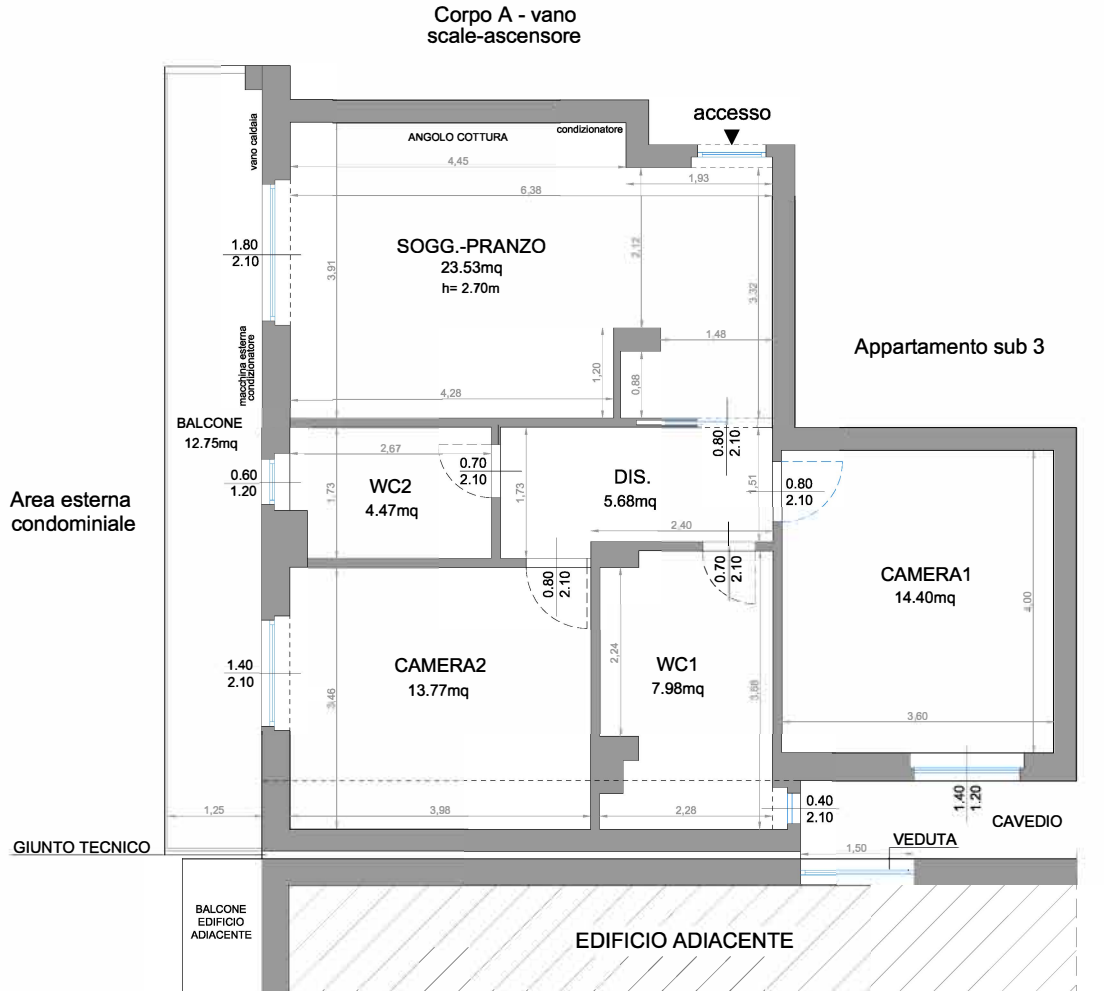

SCHEDA IMMOBILE											
N.	SOPRALLUOGO	DATA	SCALA	PIANO	SUB	CAT	RAPP.	SUP. NETTA	SUP. BALC.	SUP. OMI	SUP. Qmq
2	4	15.03.23	A	1	2	A/2	1:100	69.83 mq	12.75 mq	83.37 mq	79.58 mq
									30% SUP. BALC.	3.83 mq	
									25% SUP. BALC.		3.19 mq
									TOTALE	87.20 mq	82.77 mq



TRIBUNALE DI SALERNO - 3° SEZIONE CIVILE - E.I. N.
 260/2022 STATO DI FATTO - Proprietà (Omissis)
 Comune di Campagna (SA) - Via Calli - Corpo A - Piano 1°
 Catasto Fabbricati Foglio 77 part 1055 sub 3

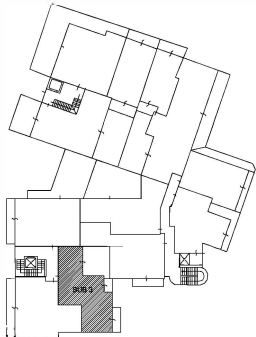
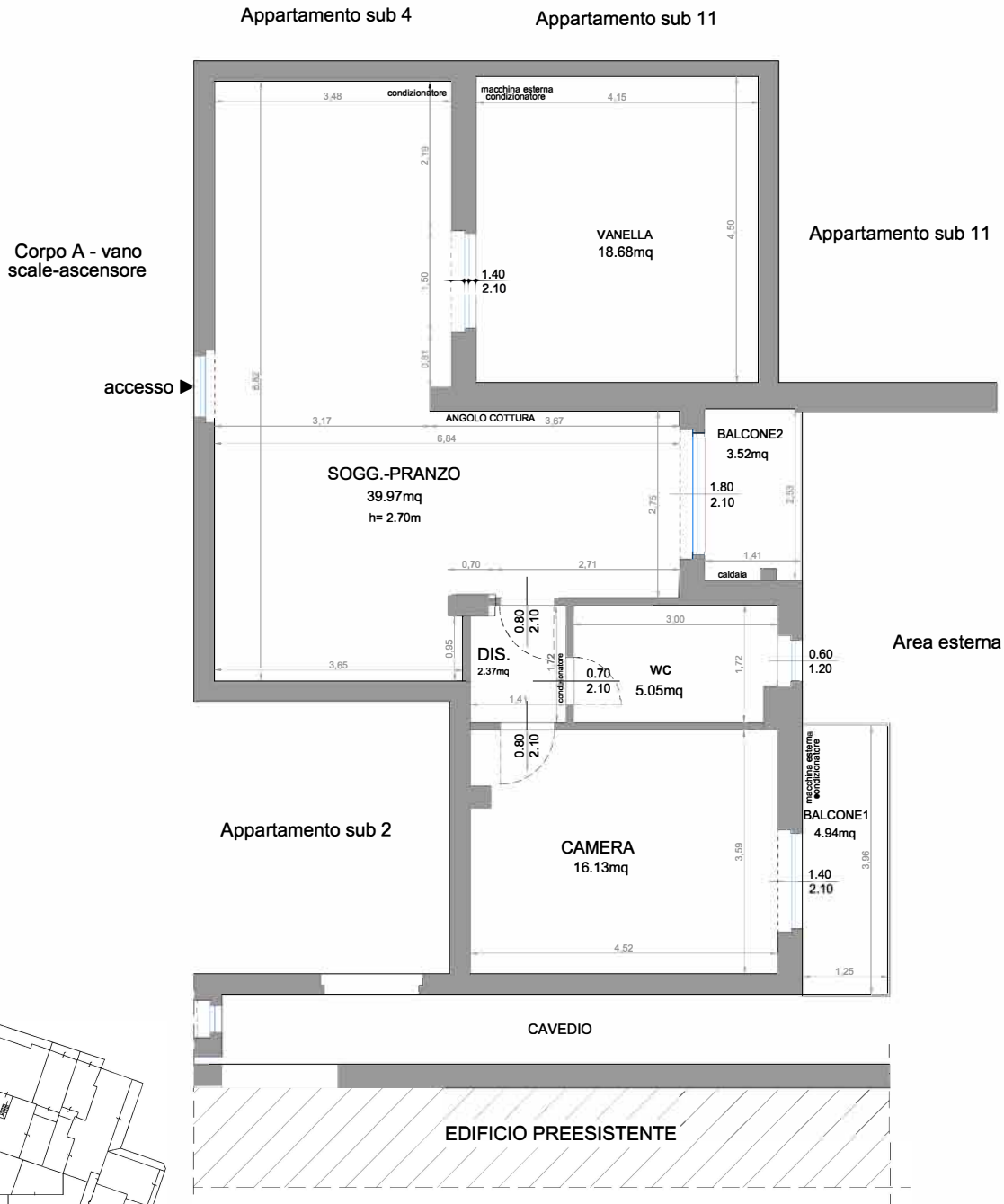

SCHEDA IMMOBILE

N.	SOPRALLUOGO	DATA	SCALA	PIANO	SUB	CAT	RAPP.	SUP. NETTA	BALCONI	VANELLA	SUP. OMI	SUP. Qmq
3	4	15.03.23	A	1	3	A/2	1:100	63.52 mq	8,46 mq	18,68 mq	76.56 mq	72.35 mq
								30% SUP. BALC. OMI 25% SUP. BALC. Qmq			2,54 mq	2,12 mq
								15% VANELLA OMI 12,5% VANELLA OMI			2,80 mq	2,34 mq
								TOTALE			81.90 mq	76.81 mq



TRIBUNALE DI SALERNO - 3° SEZIONE CIVILE - E.I. N. 260/2022
 STATO DI FATTO - Proprietà (Omissis)
 Comune di Campagna (SA) - Via Calli - Corpo A - Piani 2° e 3° Sottotetto
 Catasto Fabbricati Foglio 77 part 1055 sub 5

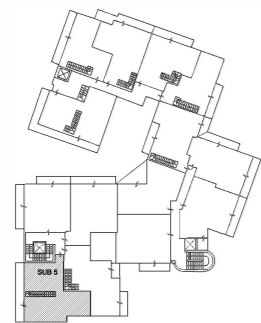
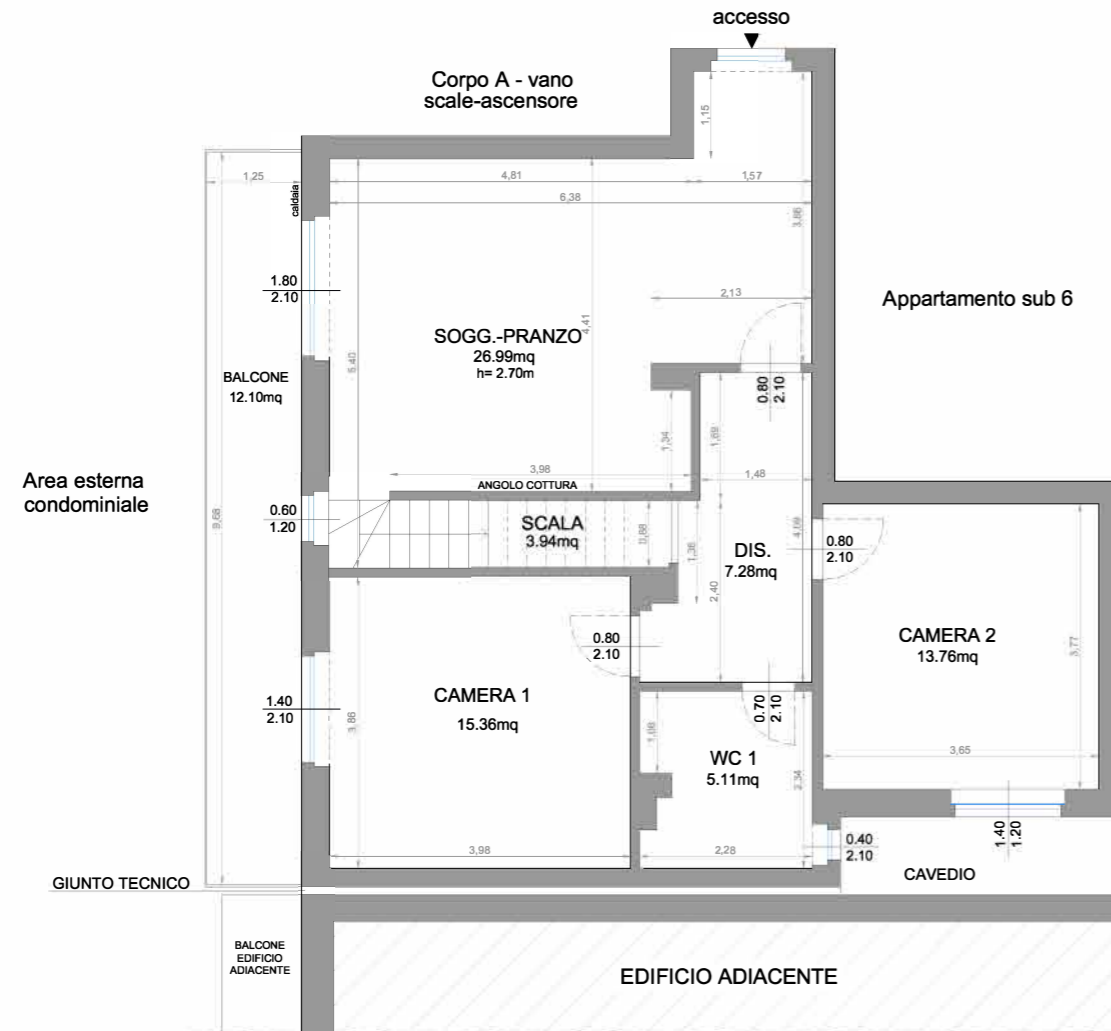

SCHEDA IMMOBILE											
N.	SOPRALLUOGO	DATA	SCALA	PIANO	SUB	CAT	RAPP.	SUP. NETTA	SUP. BALC.	SUP. OMI	SUP. Qmq
4A	3	08.03.23	A	2	5	A/2	1:100	72.44 mq	12,10 mq	86.06 mq	82.56 mq
									30% SUP. BALC.	3.63 mq	
									25% SUP. BALC.		3.03 mq
								TOTALE 2° PIANO		89.69 mq	85.59 mq

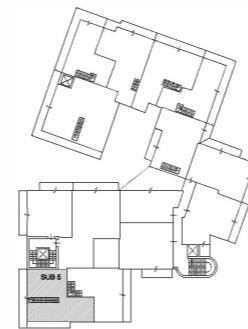
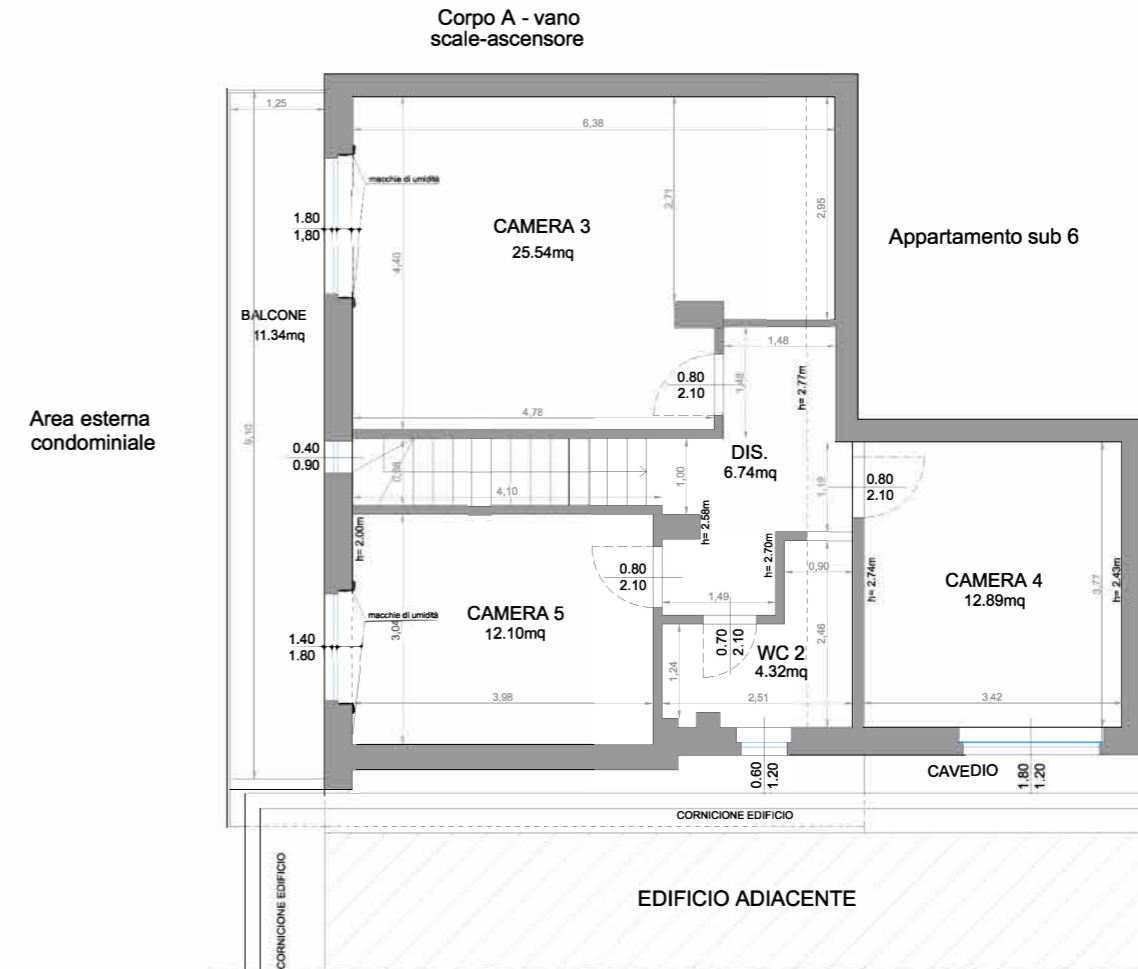

SCHEDA IMMOBILE											
N.	SOPRALLUOGO	DATA	SCALA	PIANO	SUB	CAT	RAPP.	SUP. NETTA	SUP. BALC.	SUP. OMI	SUP. Qmq
4B	3	08.03.23	A	3° SOTT.	5	A/2	1:50	61.59 mq	11.34 mq	78.21 mq	74.65 mq
									30% SUP. BALC.	3.40 mq	
									25% SUP. BALC.		2.84 mq
								TOTALE SOTTOTETTO		81.61 mq	77.49 mq
								SOTTOTETTO 50%		40.81 mq	38,75 mq
								TOTALE DUPLEX		130.50 mq	124.34 mq

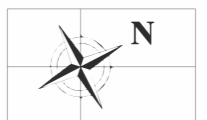

TRIBUNALE DI SALERNO - 3° SEZIONE CIVILE - E.I. N. 260/2022
 STATO DI FATTO - Proprietà (Omissis)
 Comune di Campagna (SA) - Via Calli - Corpo A - Piani 2° e 3° Sottotetto
 Catasto Fabbricati Foglio 77 part 1055 sub 6

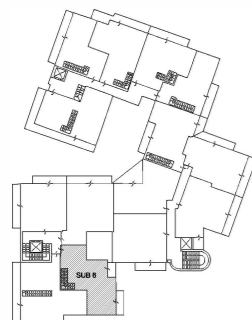
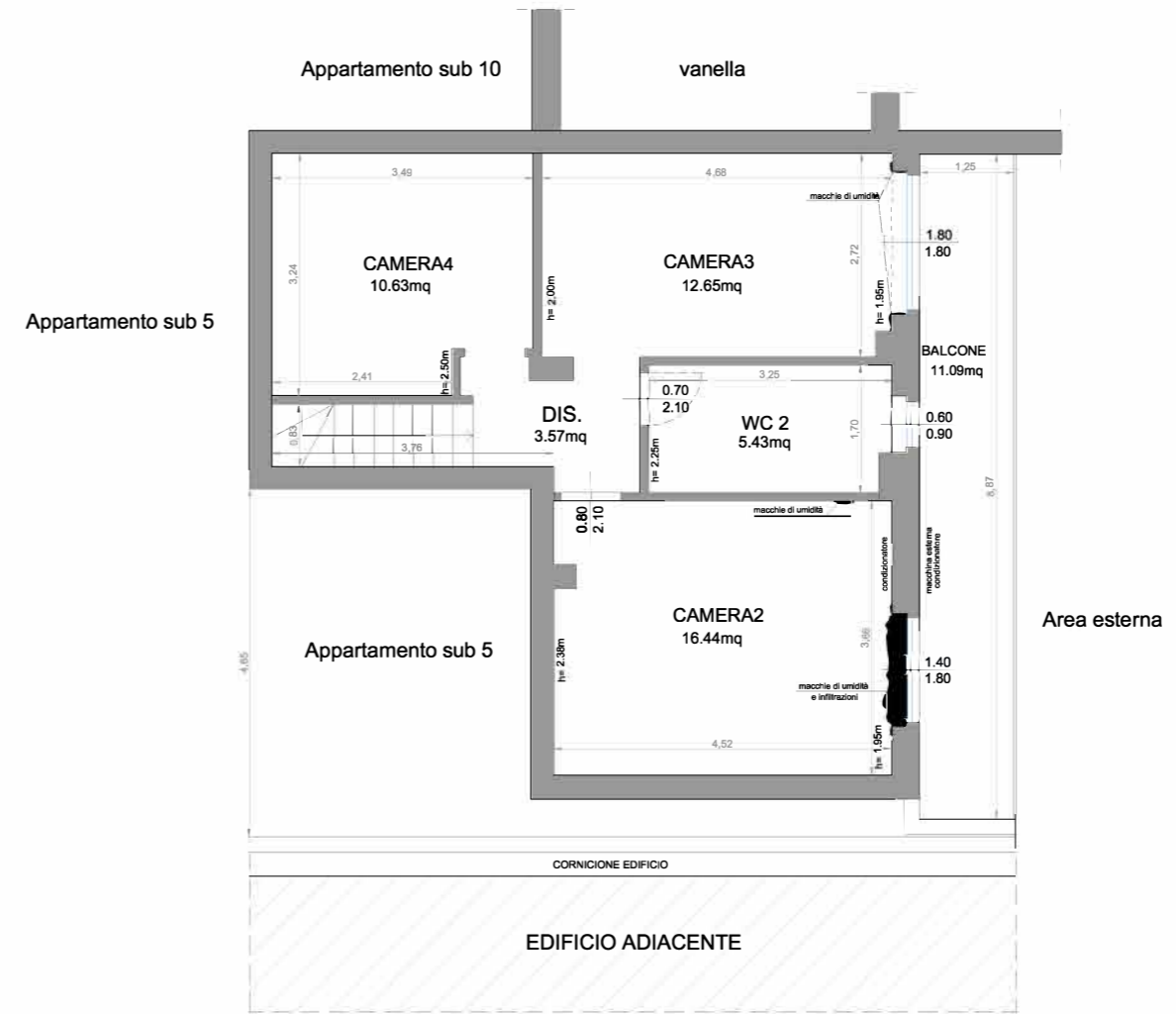
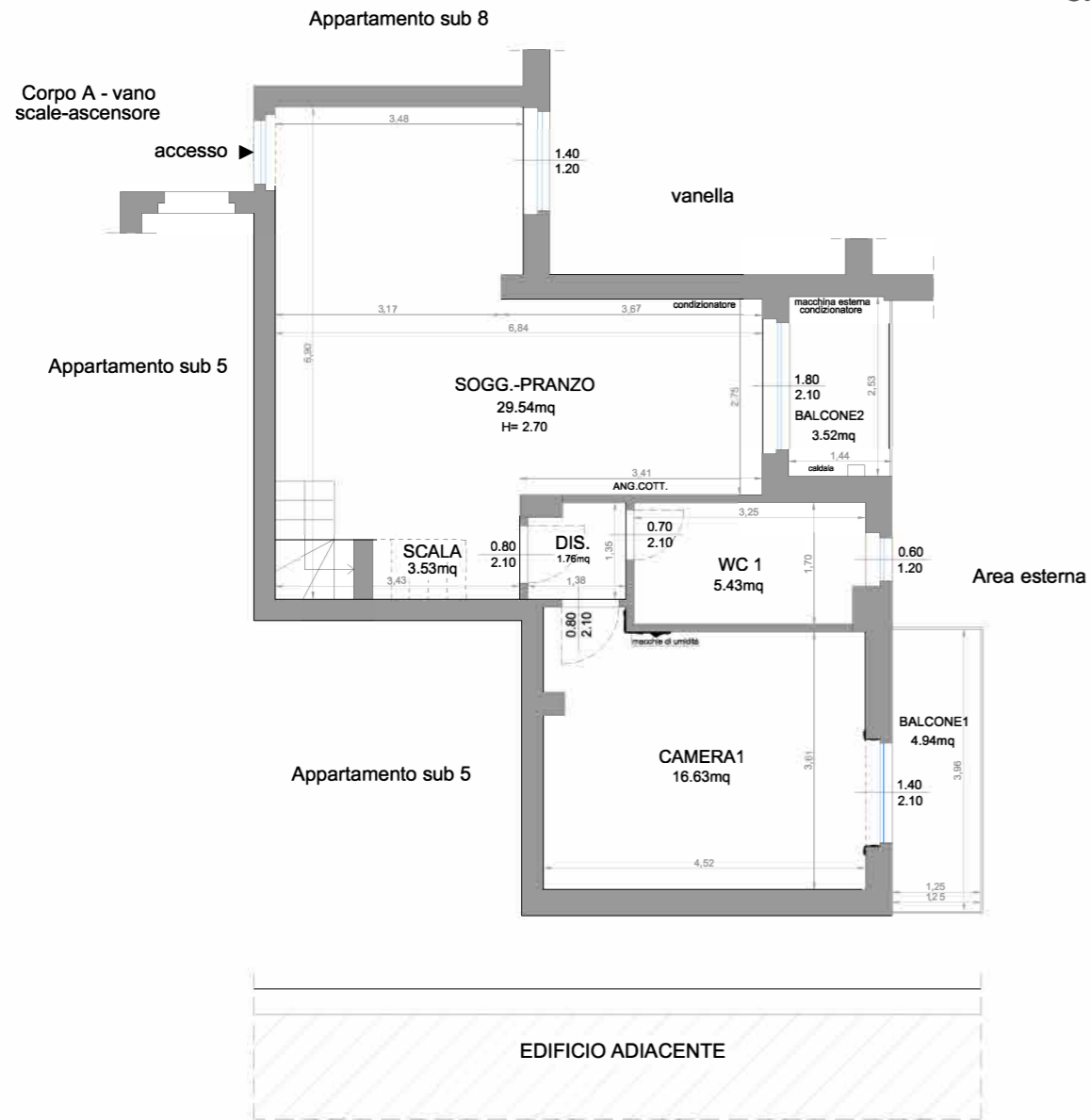

SCHEDA IMMOBILE											
N.	SOPRALLUOGO	DATA	SCALA	PIANO	SUB	CAT	RAPP.	SUP. NETTA	SUP. BALC.	SUP. OMI	SUP. Qmq
5A	4	15.03.23	A	2	6	A/2	1:100	56.89 mq	8.46 mq	68.31 mq	65.01 mq
									30%SUP. BALC.	2.54 mq	
									25%SUP. BALC.		2.12 mq
TOTALE 2° PIANO										70.85 mq	67.13 mq

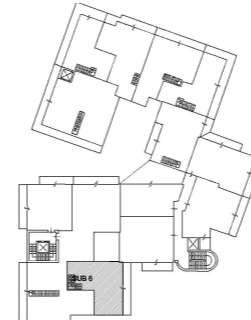

SCHEDA IMMOBILE											
N.	SOPRALLUOGO	DATA	SCALA	PIANO	SUB	CAT	RAPP.	SUP. NETTA	SUP. BALC.	SUP. OMI	SUP. Qmq
5B	4	15.03.23	A	3° SOTT.	6	A/2	1:100	48.72 mq	11.09 mq	61.77 mq	58.65 mq
									30%SUP. BALC.	3.33mq	
									25%SUP. BALC.		2.77 mq
TOTALE SOTTOTETTO										65.10 mq	61.42 mq
SOTTOTETTO 50%										32.55 mq	30,71 mq
TOTALE DUPLEX										103.43 mq	97.86 mq

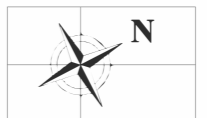

TRIBUNALE DI SALERNO - 3° SEZIONE CIVILE - E.I. N.
 260/2022 STATO DI FATTO - Proprietà (Om^{nia}ss^{us})
 Comune di Campagna (SA) - Via Calli - Corpo A - Piano 2°
 Catasto Fabbricati Foglio 77 part 1055 sub 7

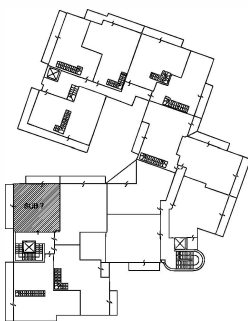
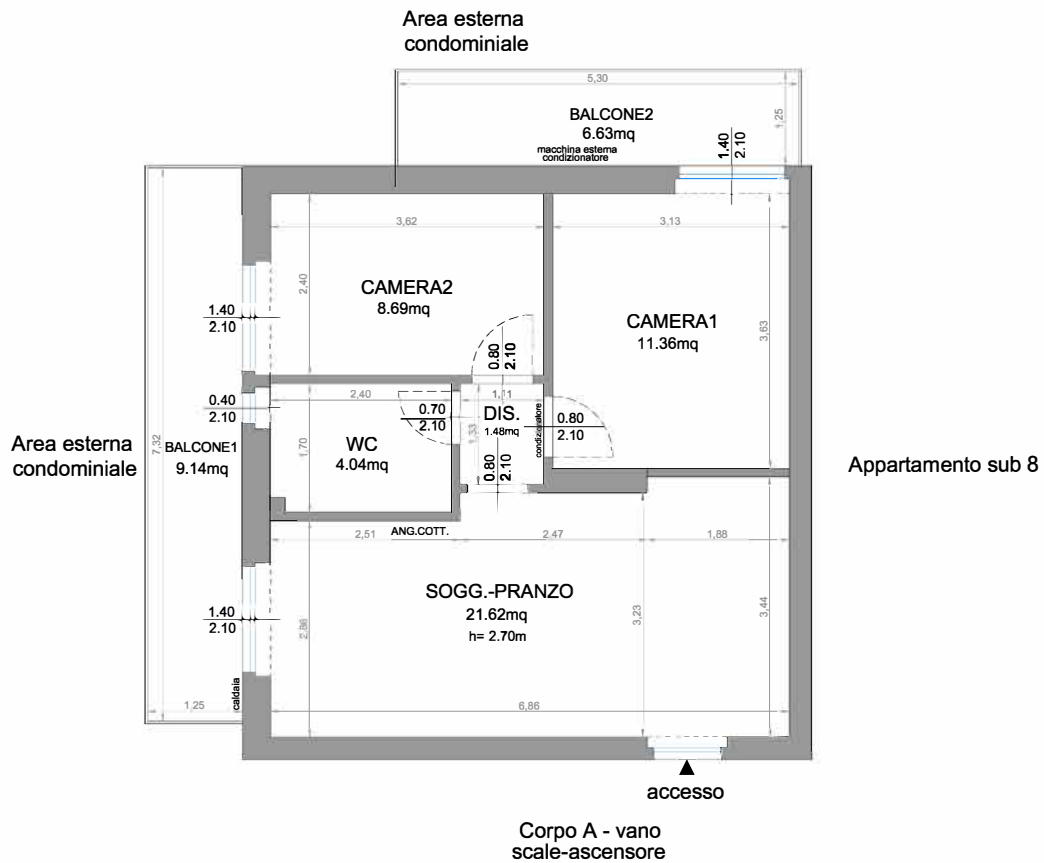

SCHEDA IMMOBILE

N.	SOPRALLUOGO	DATA	SCALA	PIANO	SUB	CAT	RAPP.	SUP. NETTA	SUP. BALC.	SUP. OMI	SUP. Qmq
6	6	29.03.23	A	2	7	A/2	1:100	47.19 mq	15.77 mq	56.81 mq	54.07 mq
									30%SUP. BALC.	4.73 mq	
									25%SUP. BALC.		3.94 mq
									TOTALE	61.54 mq	58,01 mq



TRIBUNALE DI SALERNO - 3° SEZIONE CIVILE - E.I. N.
260/2022 STATO DI FATTO - Proprietà (Omissis)
Comune di Campagna (SA) - Via Calli - Corpo A - Piano 2°
Catasto Fabbricati Foglio 77 part 1055 sub 8

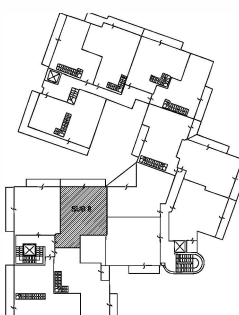
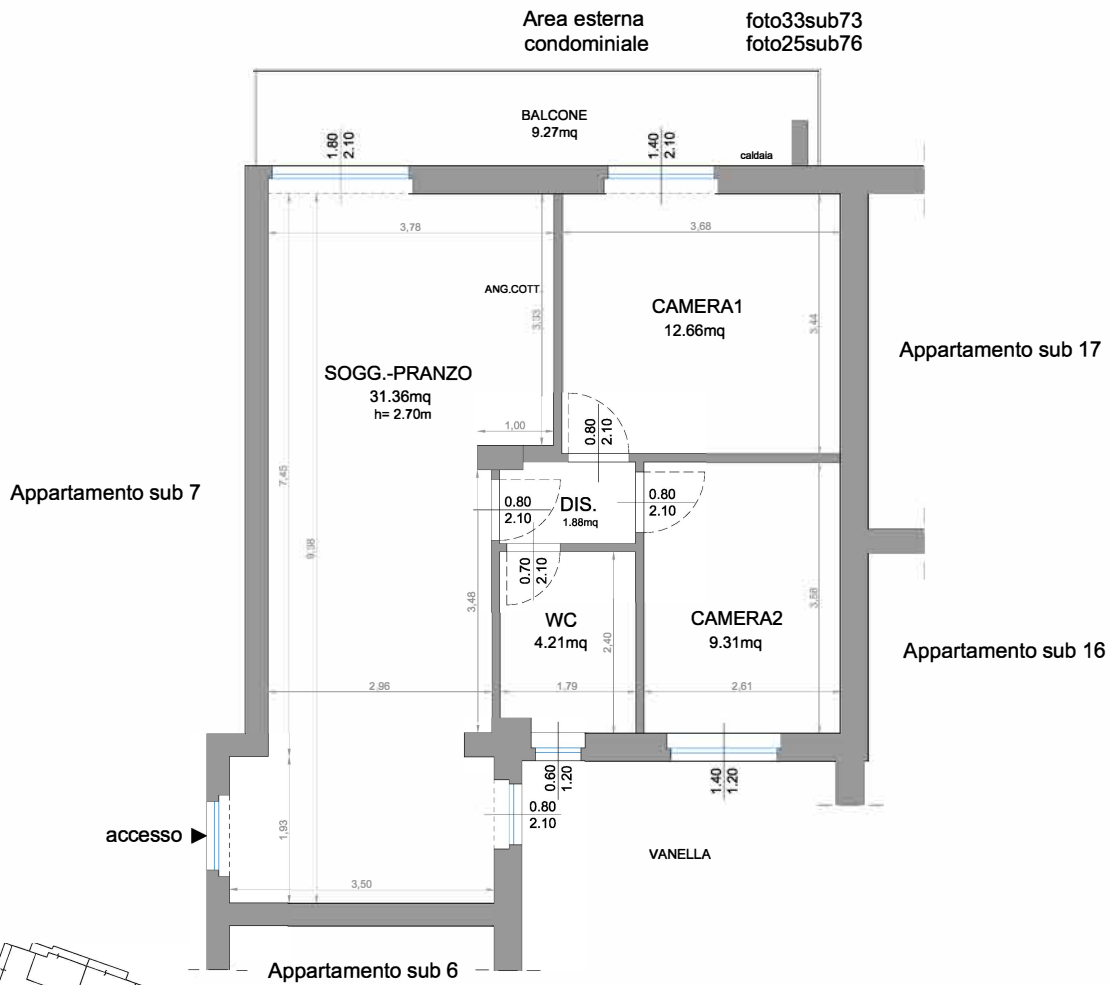

SCHEDA IMMOBILE

N.	SOPRALLUOGO	DATA	SCALA	PIANO	SUB	CAT	RAPP.	SUP. NETTA	SUP. BALC.	SUP. OMI	SUP. Qmq
7	5	22.03.23	A	2	8	A/2	1:100	59.42 mq	9.27 mq	70.48 mq	67.79 mq
									30% SUP. BALC.	2.78 mq	
									25% SUP. BALC.		2.32 mq
									TOTALE	73.26 mq	70.11 mq



TRIBUNALE DI SALERNO - 3° SEZIONE CIVILE - E.I. N.
 260/2022 STATO DI FATTO - Proprietà (Omissis)
 Comune di Campagna (SA) - Via Calli - Corpo A - Piano 3°
 Catasto Fabbricati Foglio 77 part 1055 sub 9

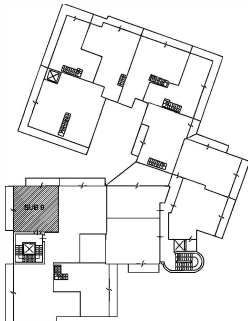
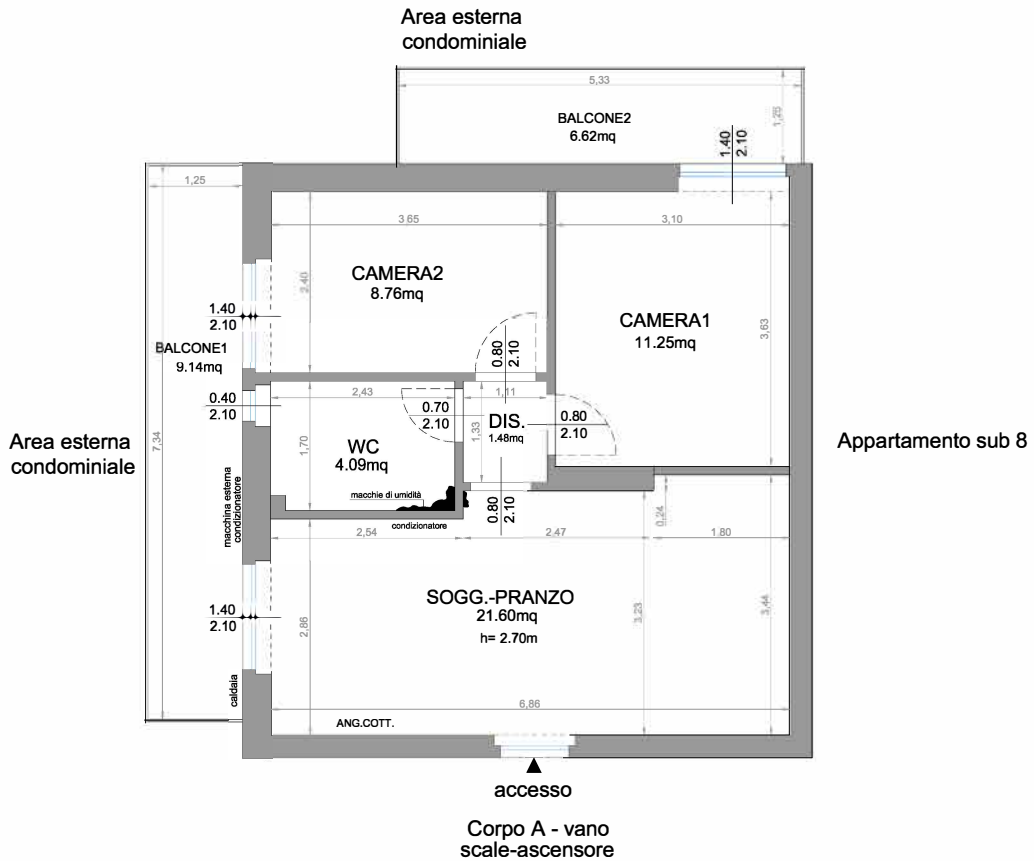

SCHEDA IMMOBILE

N.	SOPRALLUOGO	DATA	SCALA	PIANO	SUB	CAT	RAPP.	SUP. NETTA	SUP. BALC.	SUP. OMI	SUP. Qmq
8	2	01.03.23	A	3	9	A/2	1:100	47.18 mq	15.76 mq	56.81 mq	54.07 mq
									30%SUP. BALC.	4.73 mq	
									25%SUP. BALC.		3.94 mq
									TOTALE	61.54 mq	58.01 mq



RILIEVI DELLO STATO DI FATTO

FABBRICATO SITO IN CAMPAGNA (SA) VIA CALLI – FOGLIO 77 PART. 1055

CORPO B

9-SUB 11
10-SUB 12
11-SUB 73
12-SUB 14
13-SUB 15
14-SUB 16
15-SUB 17
16-SUB 18
17-SUB 19
18-SUB 20
19-SUB 21
20-SUB 22
21-SUB 24
22-SUB 25
23-SUB 26
24-SUB 27

TRIBUNALE DI SALERNO - 3° SEZIONE CIVILE - E.I. N.
 260/2022 STATO DI FATTO - Proprietà (Omissis)
 Comune di Campagna (SA) - Via Calli - Corpo B - Piano 1°
 Catasto Fabbricati Foglio 77 part 1055 sub 11

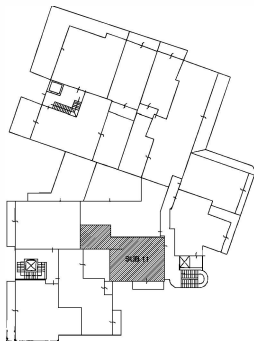
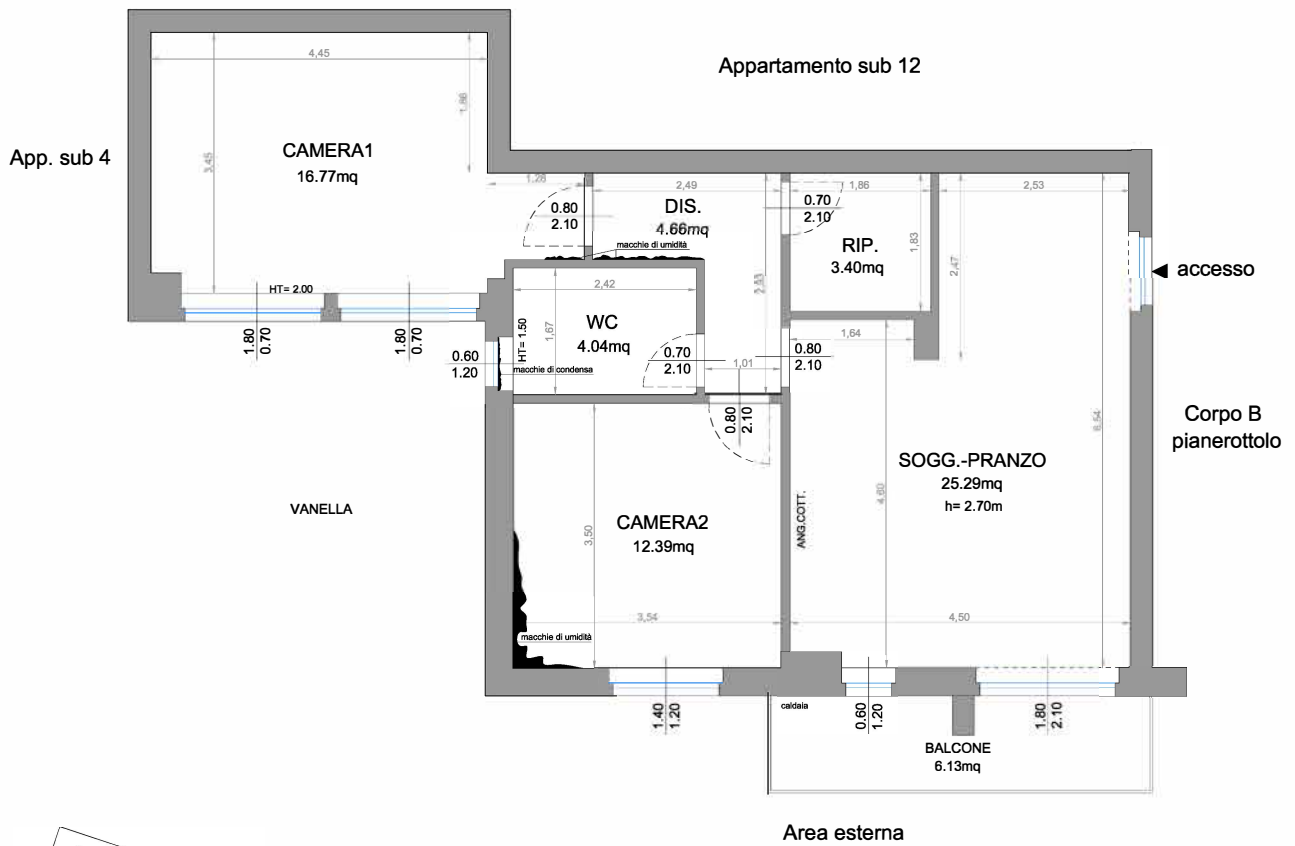

SCHEDA IMMOBILE

N.	SOPRALLUOGO	DATA	SCALA	PIANO	SUB	CAT	RAPP.	SUP. NETTA	SUP. BALC.	SUP. OMI	SUP. Qmq
9	7	05.04.23	B	1	11	A/2	1:100	66.55mq	6.13 mq	79.68 mq	76.32 mq
									30%SUP. BALC.	1.84 mq	
									25%SUP. BALC.		1.53 mq
									TOTALE	81.52mq	77.85 mq



TRIBUNALE DI SALERNO - 3° SEZIONE CIVILE - E.I. N.
 260/2022 STATO DI FATTO - Proprietà (Omissis)
 Comune di Campagna (SA) - Via Calli - Corpo B - Piano 1°
 Catasto Fabbricati Foglio 77 part 1055 sub 12

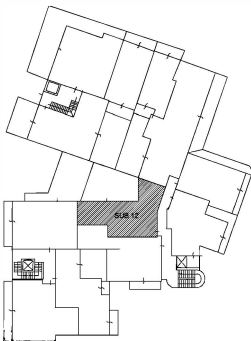
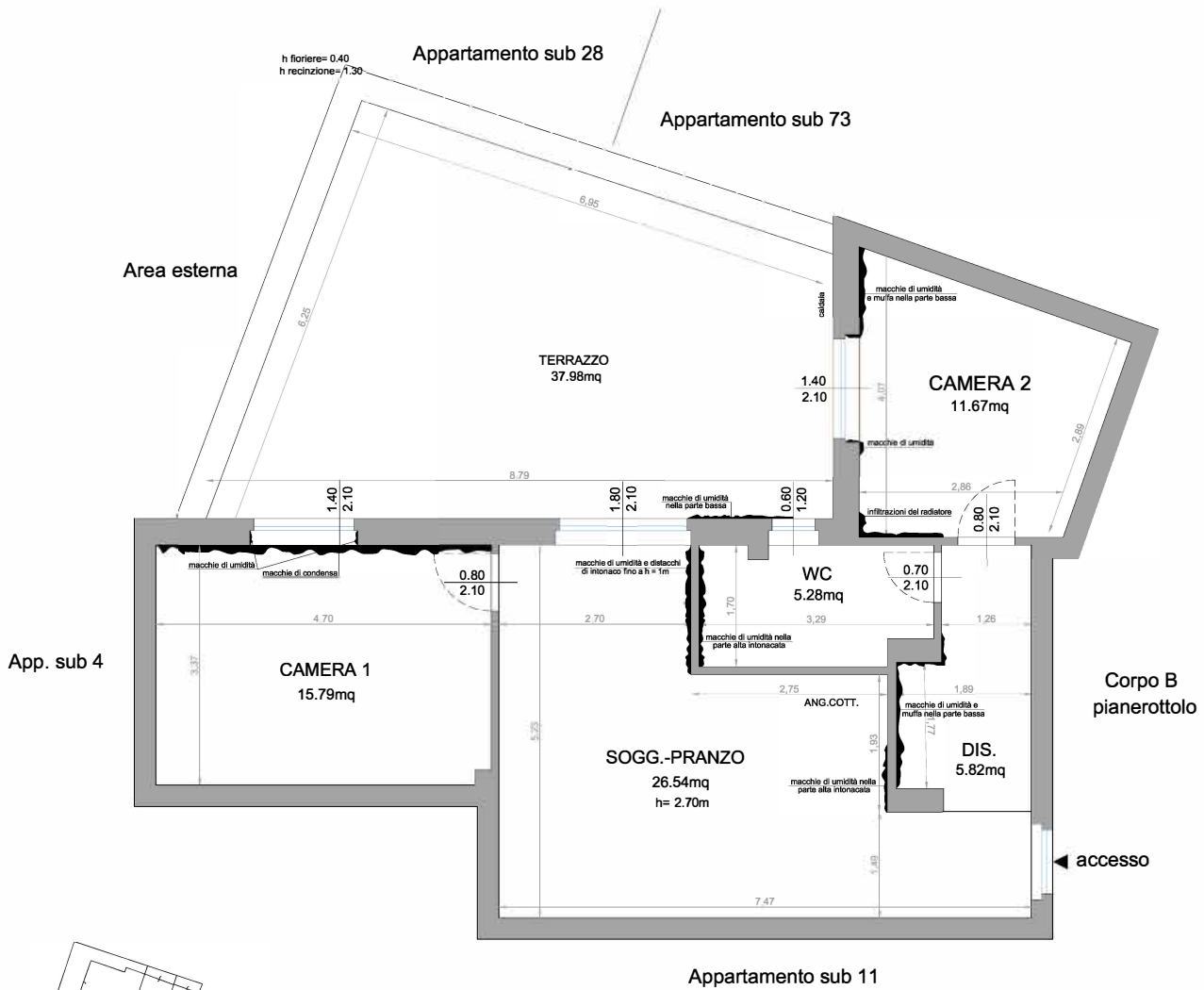

SCHEDA IMMOBILE

N.	SOPRALLUOGO	DATA	SCALA	PIANO	SUB	CAT	RAPP.	SUP. NETTA	SUP. BALC.	SUP. OMI	SUP. Qmq
10	8	12.04.23	B	1	12	A/2	1:100	65.10 mq	37.98 mq	77.00 mq	74.44 mq
	11	21.09.23							30% SUP. BALC. 10% OLTRE 25 MQ	8.80 mq	
									25% SUP. BALC.		9.50 mq
									TOTALE	85.80 mq	83.94 mq



TRIBUNALE DI SALERNO - 3° SEZIONE CIVILE - E.I. N.
260/2022 STATO DI FATTO - Proprietà (Omissis)
Comune di Campagna (SA) - Via Calli - Corpo B - Piano 1°
Catasto Fabbricati Foglio 77 part 1055 sub 73

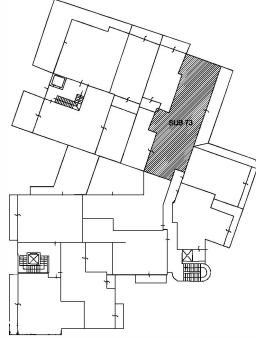
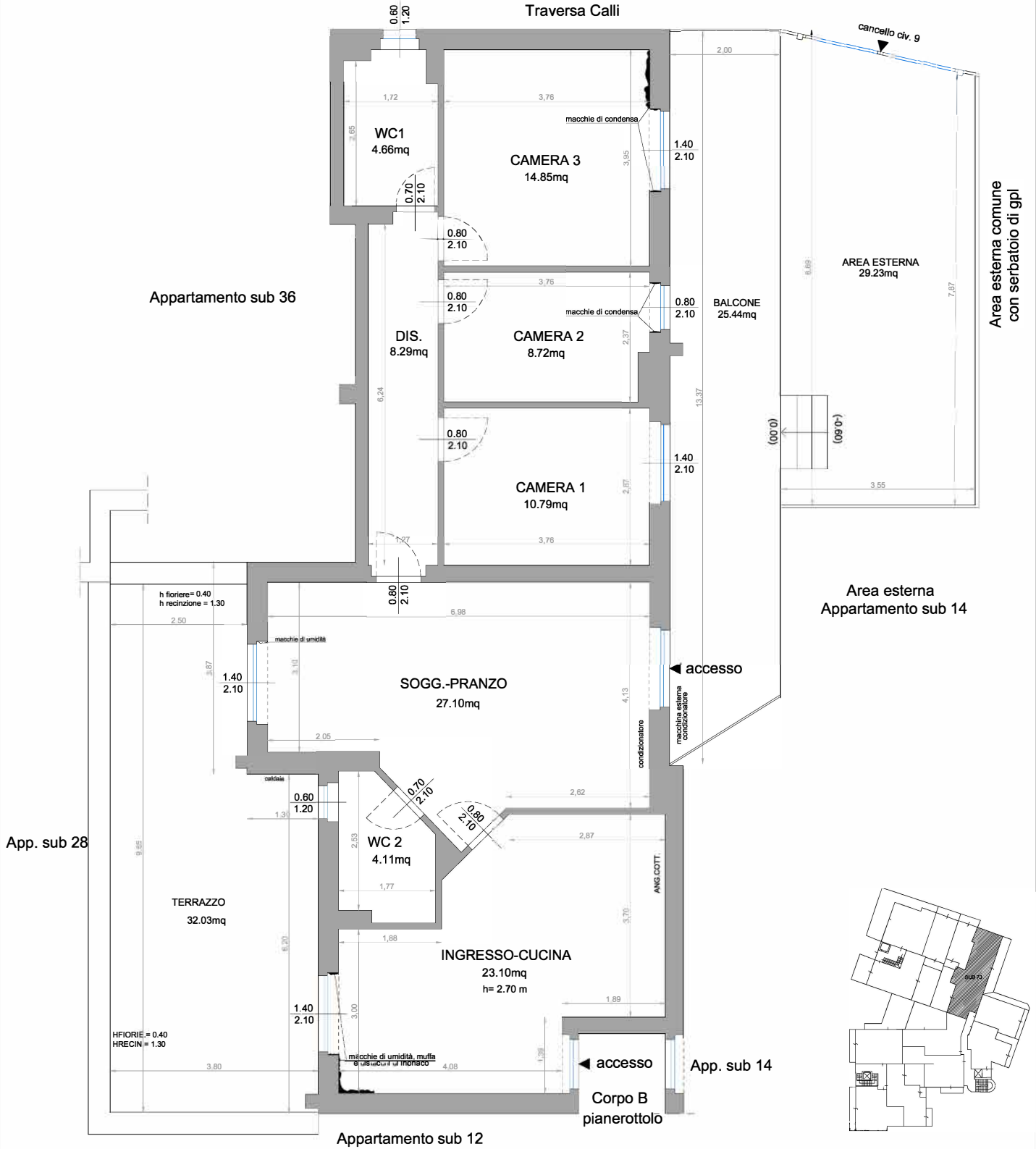

Appartamento sub 12

SCHEDA IMMOBILE												
N.	SOPRALLUOGO	DATA	SCALA	PIANO	SUB	CAT	RAPP.	SUP. NETTA	SUP. BALCONI	SUP. AREA	SUP. OMI	SUP. Qmq
11	8	12.04.23	B	1	73	A/2	1:100	101.61 mq	57.47 mq	29.23 mq	122.13 mq	116.47 mq
									30% SUP. BALC. OMI		15.83 mq	14.37 mq
									25% SUP. BALC. Qmq			
									30% e 10% AREA OMI		7.92 mq	7.31 mq
									25% AREA Qmq			
								TOTALE			145.88 mq	138.15 mq

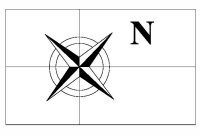

TRIBUNALE DI SALERNO - 3° SEZIONE CIVILE - E.I. N.
 260/2022 STATO DI FATTO - Proprietà (Omissis)
 Comune di Campagna (SA) - Via Calli- Corpo B - Piano 1°
 Catasto Fabbricati Foglio 77 part 1055 sub 14

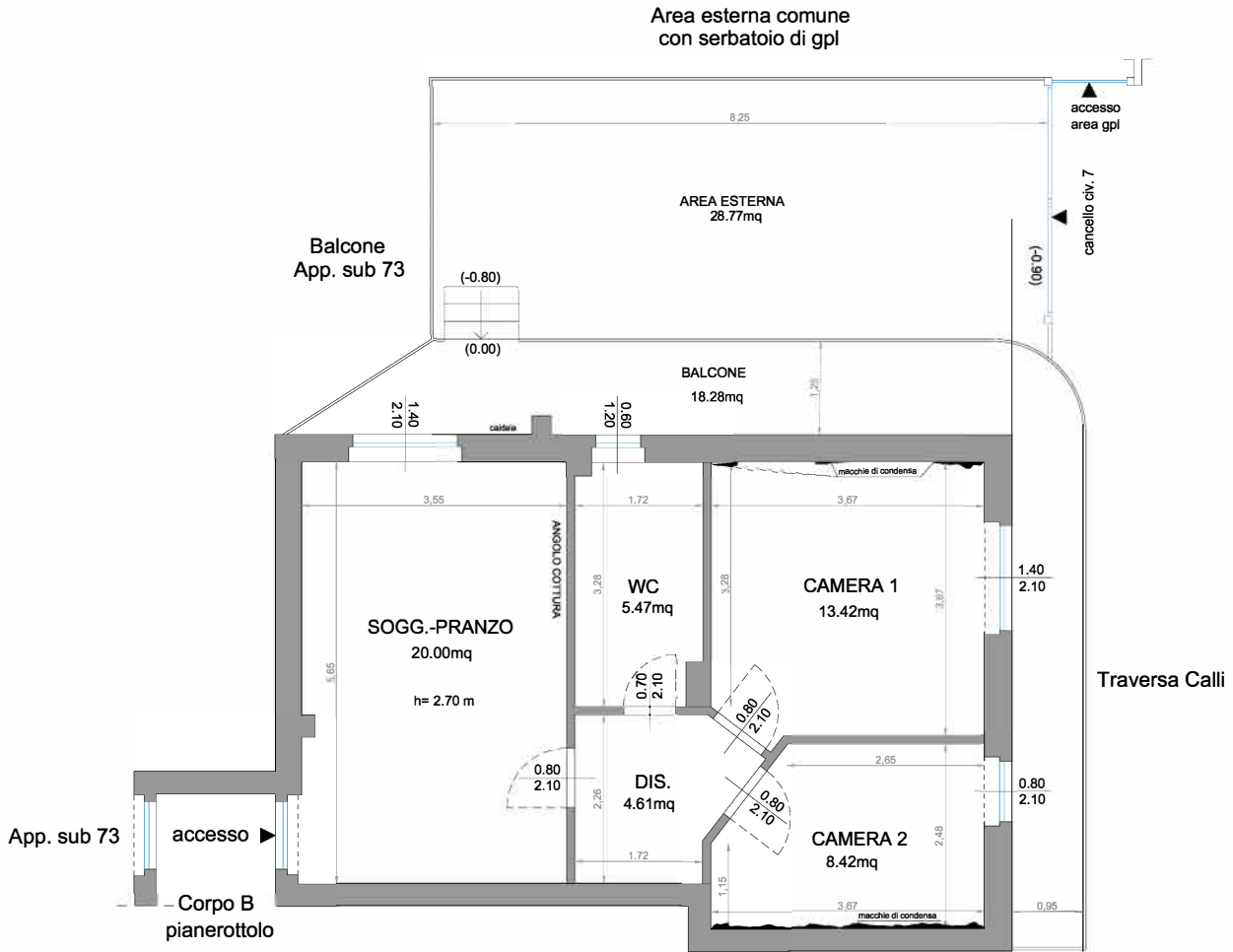

Appartamento sub 15

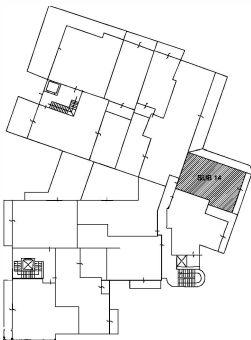

SCHEDA IMMOBILE

N.	SOPRALLUOGO	DATA	SCALA	PIANO	SUB	CAT	RAPP.	SUP. NETTA	SUP. BALC.	SUP. OMI	SUP. Qmq
12	4	15.03.23	B	1	14	A/2	1:100	51.92 mq	18.28 mq	63,52 mq	59.31 mq
									SUP. BALCONI	5.48 mq (30%)	4,57mq (25%)
									TOTALE	69.00 mq	63.88 mq
									AREA ESTERNA 28,77 mq	7.88 mq (30% e 10%)	7,19 mq (25%)
									TOTALE	76.88 mq	71.07 mq



TRIBUNALE DI SALERNO - 3° SEZIONE CIVILE - E.I. N.
 260/2022 STATO DI FATTO - Proprietà (Omissis)
 Comune di Campagna (SA) - Via Calli - Corpo B - Piano 1°
 Catasto Fabbricati Foglio 77 part 1055 sub 15

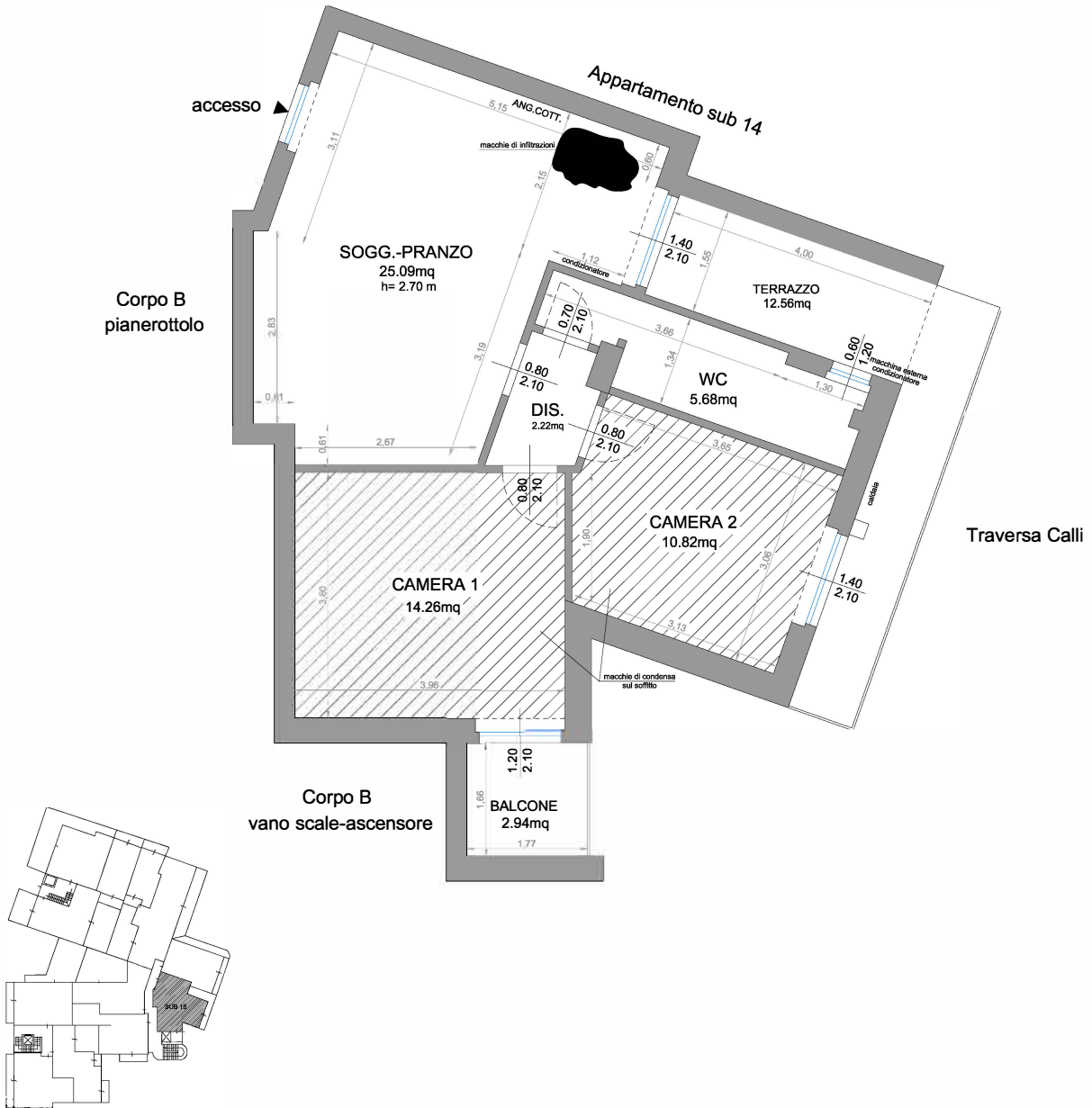

SCHEDA IMMOBILE

N.	SOPRALLUOGO	DATA	SCALA	PIANO	SUB	CAT	RAPP.	SUP. NETTA	SUP. BALC.	SUP. OMI	SUP. Qmq
13	6	29.03.23	B	1	15	A/2	1:100	58.07 mq	15.50 mq	69.43 mq	66.10 mq
									30% SUP. BALC.	4.65 mq	
									25% SUP. BALC.		3.88 mq
									TOTALE	74.08 mq	69.98 mq



TRIBUNALE DI SALERNO - 3° SEZIONE CIVILE - E.I. N.
 260/2022 STATO DI FATTO - Proprietà (Omissis)
 Comune di Campagna (SA) - Via Calli - Corpo B - Piano 2°
 Catasto Fabbricati Foglio 77 part 1055 sub 16

Appartamento sub 17

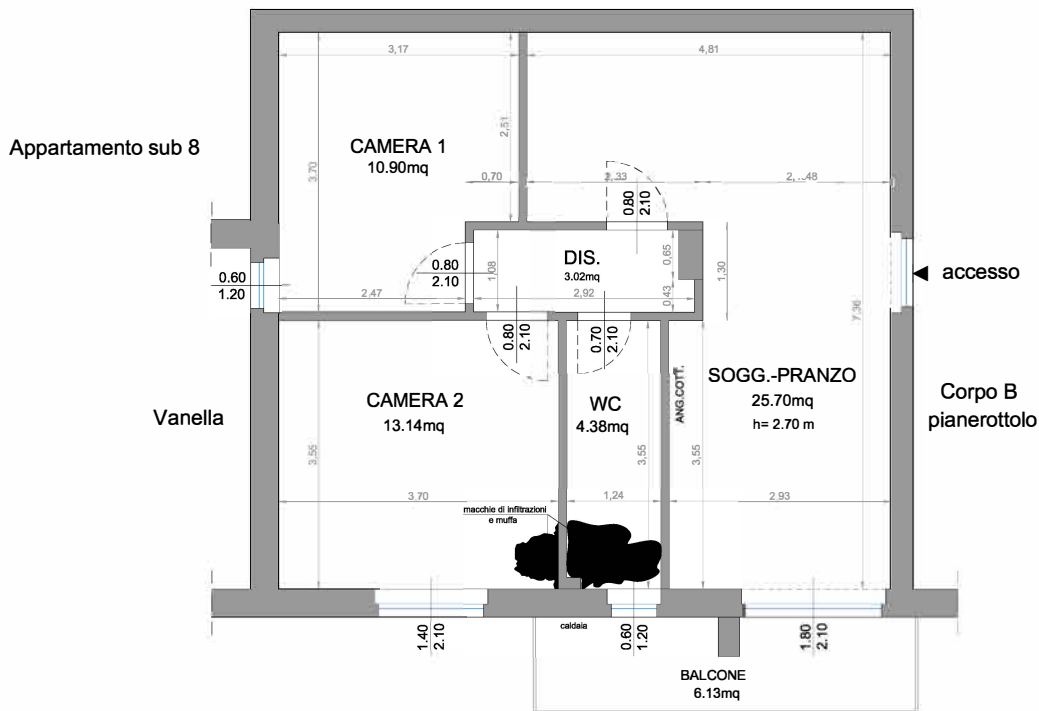

Area esterna

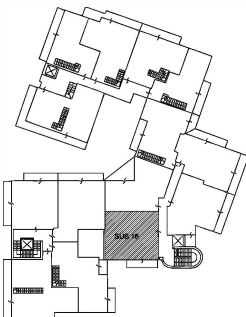

SCHEDA IMMOBILE

N.	SOPRALLUOGO	DATA	SCALA	PIANO	SUB	CAT	RAPP.	SUP. NETTA	SUP. BALC.	SUP. OMI	SUP. Qmq
14	7	05.04.23	B	2	16	A/2	1:100	57.14 mq	6.13 mq	67.29 mq	64.83 mq
	13	10.05.24							30%SUP. BALC.	1.84 mq	
									25%SUP. BALC.		1.53 mq
									TOTALE	69.13 mq	66.36 mq



TRIBUNALE DI SALERNO - 3° SEZIONE CIVILE - E.I. N.
 260/2022 STATO DI FATTO - Proprietà (Omissis)
 Comune di Campagna (SA) - Via Calli - Corpo B - Piano 2°
 Catasto Fabbricati Foglio 77 part 1055 sub 17

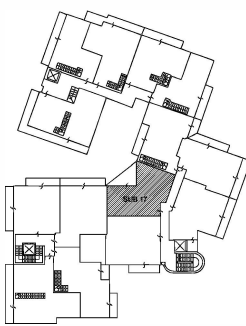
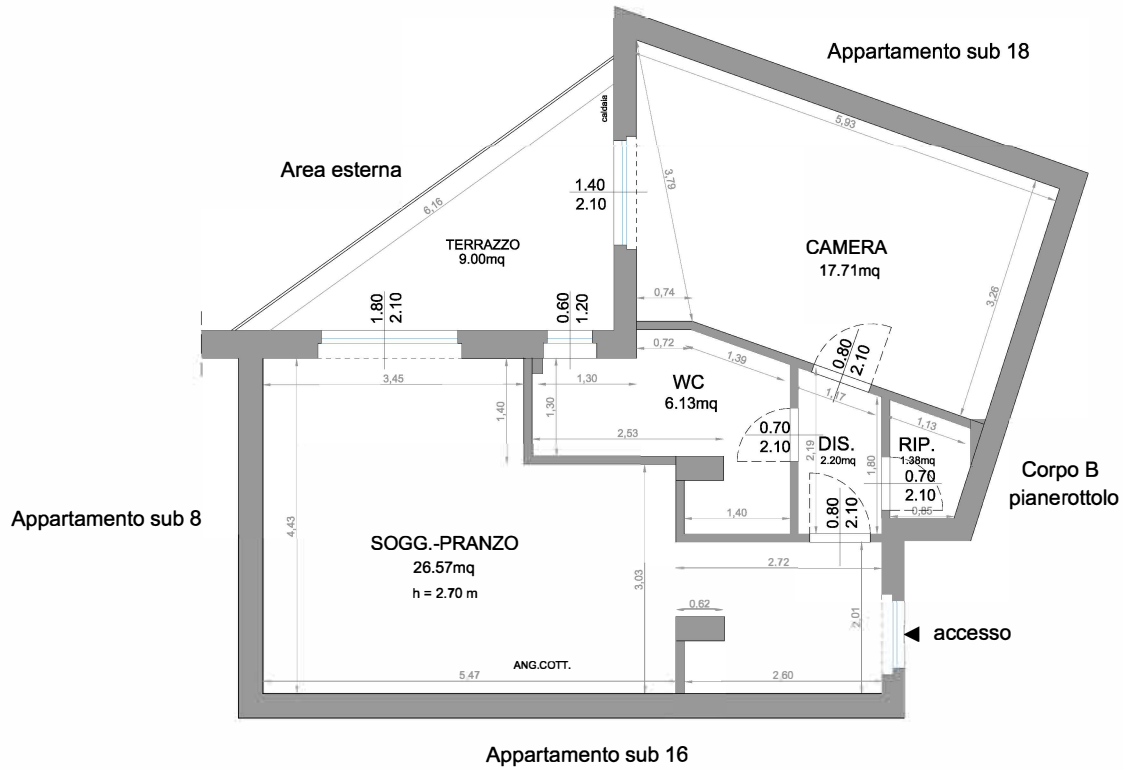

SCHEDA IMMOBILE											
N.	SOPRALLUOGO	DATA	SCALA	PIANO	SUB	CAT	RAPP.	SUP. NETTA	SUP. BALC.	SUP. OMI	SUP. Qmq
15	10	03.05.23	B	2	17	A/2	1:100	53.99 mq	9.00 mq	63.66 mq	62.21 mq
									30% SUP. BALC.	2.70 mq	
									25% SUP. BALC.		2.25 mq
									TOTALE	66.36 mq	64.46 mq



TRIBUNALE DI SALERNO - 3° SEZIONE CIVILE - E.I. N. 260/2022
 STATO DI FATTO - Proprietà (Omissis)
 Comune di Campagna (SA) - Via Calli - Corpo B - Piano 2° e 3° Sottotetto
 Catasto Fabbricati Foglio 77 part 1055 sub 18

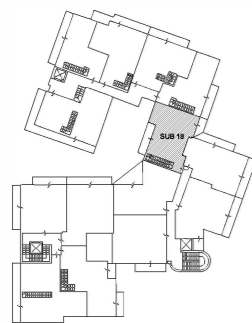
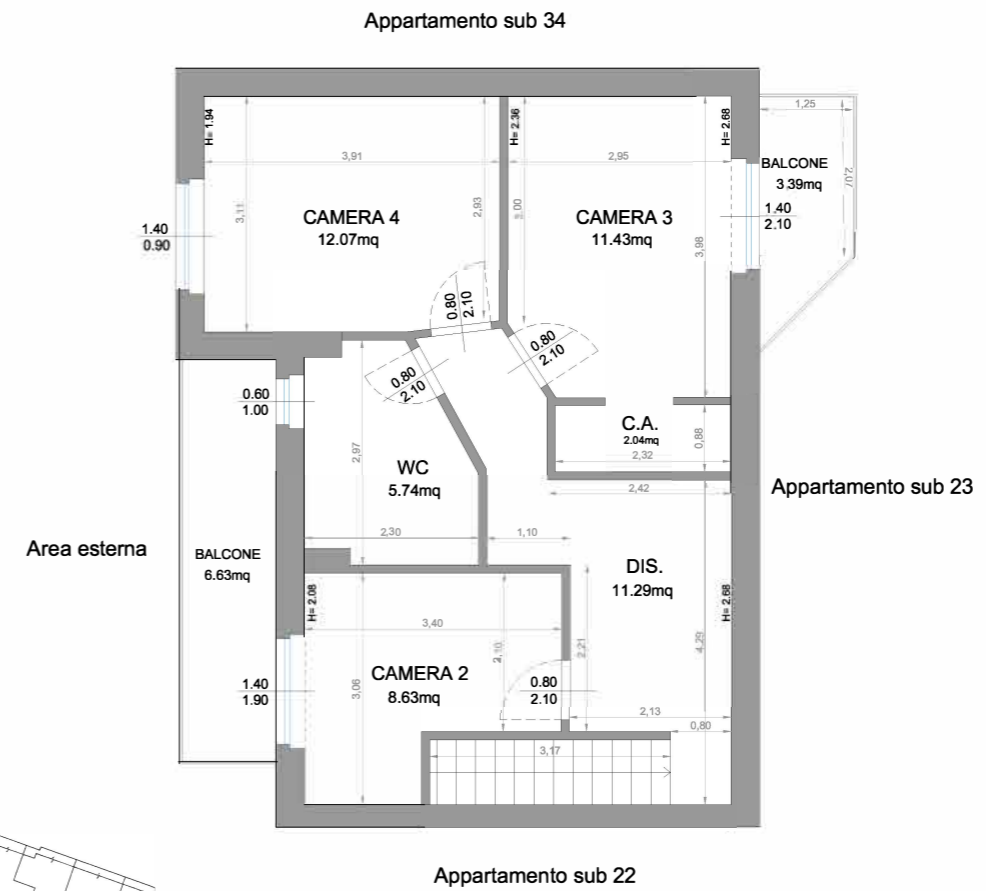
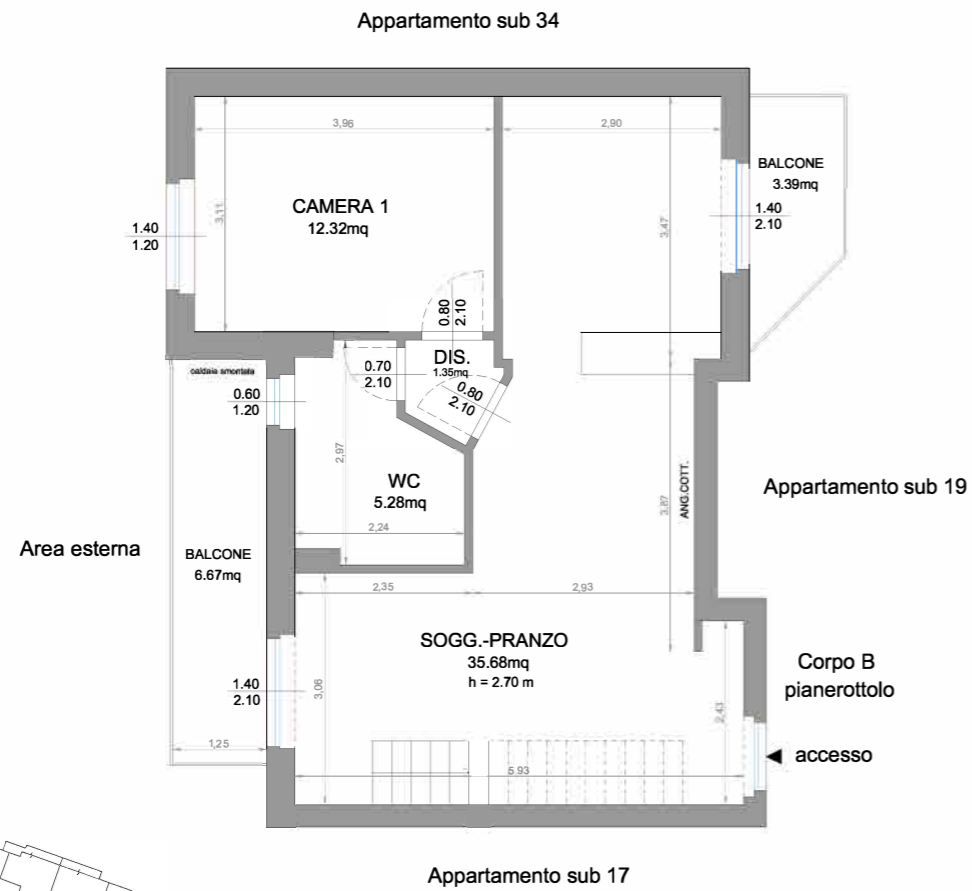

SCHEDA IMMOBILE											
N.	SOPRALLUOGO	DATA	SCALA	PIANO	SUB	CAT	RAPP.	SUP. NETTA	SUP. BALC.	SUP. OMI	SUP. Qmq
16A	2	01.03.23	B	2	18	A/2	1:100	54.63 mq	10.06 mq	66.51 mq	62.34 mq
									30%SUP. BALC.	3.02 mq	
									25%SUP. BALC.		2.52 mq
TOTALE 2° PIANO									69.53 mq	64.86 mq	

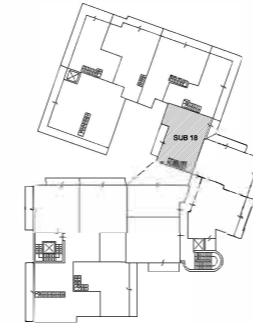

SCHEDA IMMOBILE											
N.	SOPRALLUOGO	DATA	SCALA	PIANO	SUB	CAT	RAPP.	SUP. NETTA	SUP. BALC.	SUP. OMI	SUP. Qmq
16B	2	01.03.23	B	3° SOTT.	18	A/2	1:100	51.20 mq	10.02 mq	67.07 mq	62.90 mq
									30%SUP. BALC.	3.01 mq	
									25%SUP. BALC.		2.51 mq
TOTALE SOTTOTETTO									70.08 mq	65.41 mq	
SOTTOTETTO 50%									35.04 mq	32.71 mq	
TOTALE DUPLEX									104.51 mq	97.57 mq	



TRIBUNALE DI SALERNO - 3° SEZIONE CIVILE - E.I. N.
 260/2022 STATO DI FATTO - Proprietà (Omissis)
 Comune di Campagna (SA) - Via Calli - Corpo B - Piano 2°
 Catasto Fabbricati Foglio 77 part 1055 sub 19

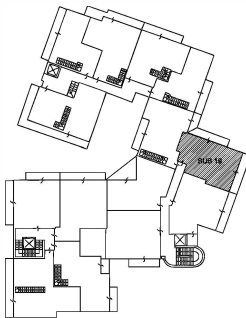
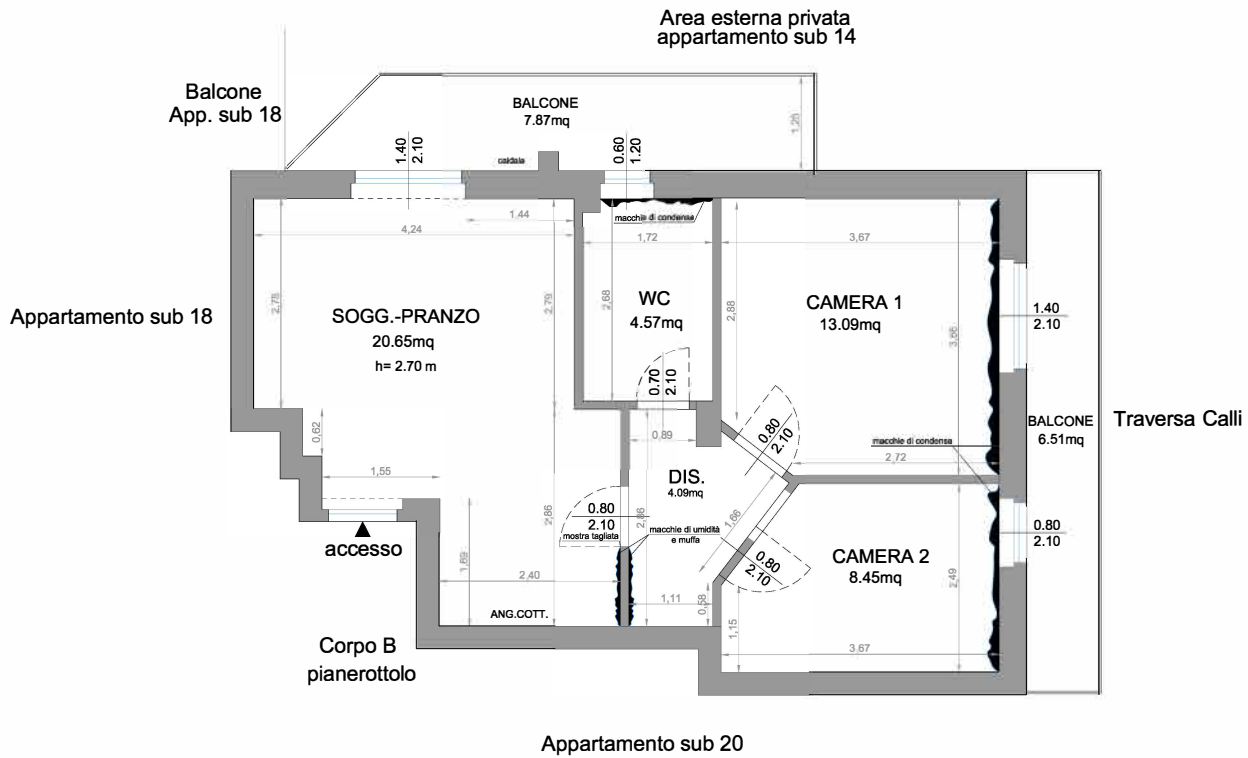

SCHEDA IMMOBILE											
N.	SOPRALLUOGO	DATA	SCALA	PIANO	SUB	CAT	RAPP.	SUP. NETTA	SUP. BALC.	SUP. OMI	SUP. Qmq
17	6	29.03.23	B	2	19	A/2	1:100	50.85 mq	14.38 mq	61.49 mq	58.35 mq
										30% SUP. BALC.	4.31 mq
										25% SUP. BALC.	3.59 mq
TOTALE										65.80 mq	61.94 mq



TRIBUNALE DI SALERNO - 3° SEZIONE CIVILE - E.I. N.
 260/2022 STATO DI FATTO - Proprietà (Omissis)
 Comune di Campagna (SA) - Via Calli - Corpo B - Piano 2°
 Catasto Fabbricati Foglio 77 part 1055 sub 20

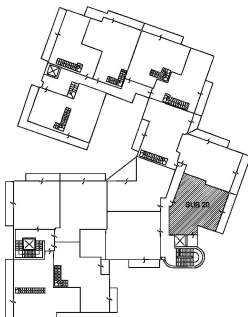
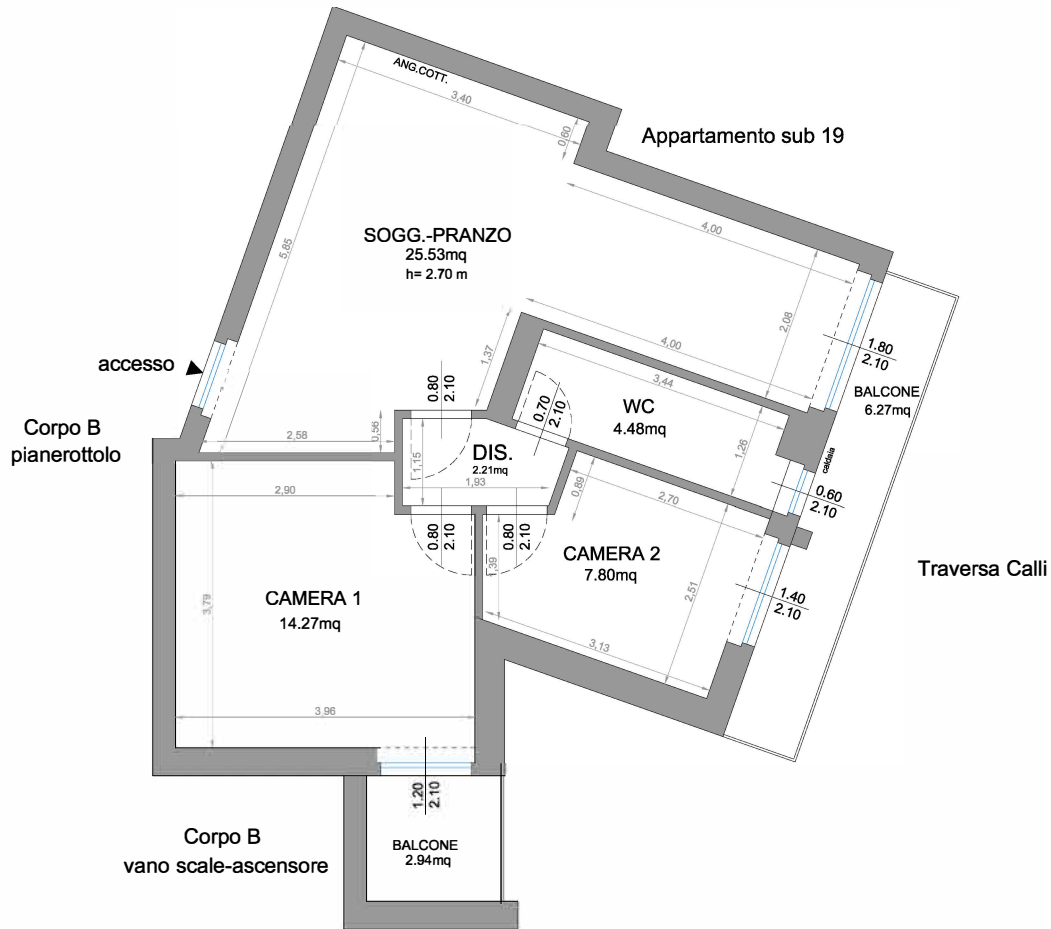

SCHEDA IMMOBILE

N.	SOPRALLUOGO	DATA	SCALA	PIANO	SUB	CAT	RAPP.	SUP. NETTA	SUP. BALC.	SUP. OMI	SUP. Qmq
18	6	29.03.23	B	2	20	A/2	1:100	54.29 mq	9.21 mq	64.97 mq	62.50 mq
									30% SUP. BALC.	2.76 mq	
									25% SUP. BALC.		2.30 mq
									TOTALE	67.73 mq	64.80 mq



TRIBUNALE DI SALERNO - 3° SEZIONE CIVILE - E.I. N.
 260/2022 STATO DI FATTO - Proprietà (Omissis)
 Comune di Campagna (SA) - Via Calli - Corpo B - Piano 3°
 Catasto Fabbricati Foglio 77 part 1055 sub 21

Appartamento sub 22

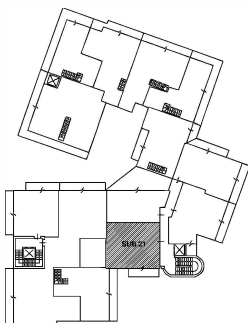
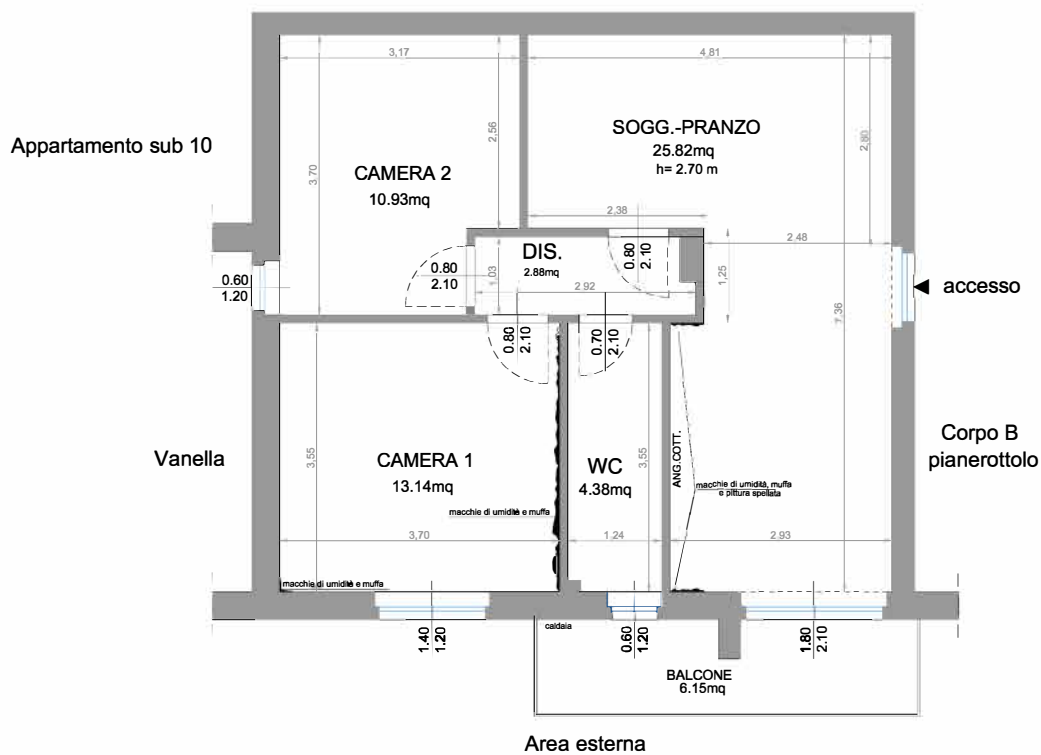

SCHEDA IMMOBILE

N.	SOPRALLUOGO	DATA	SCALA	PIANO	SUB	CAT	RAPP.	SUP. NETTA	SUP. BALC.	SUP. OMI	SUP. Qmq
19	3	08.03.23	B	3	21	A/2	1:100	57.15 mq	6.15 mq	67.35 mq	64.89 mq
										1.85 mq	
											1.54 mq
									TOTALE	69.20 mq	66.43 mq

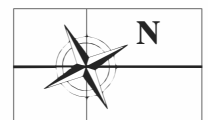

TRIBUNALE DI SALERNO - 3° SEZIONE CIVILE - E.I. N. 260/2022
 STATO DI FATTO - Proprietà (Omissis)
 Comune di Campagna (SA) - Via Calli - Corpo B - Piano 3°
 Catasto Fabbricati Foglio 77 part 1055 sub 22

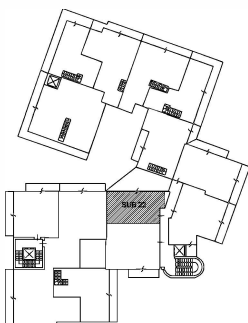
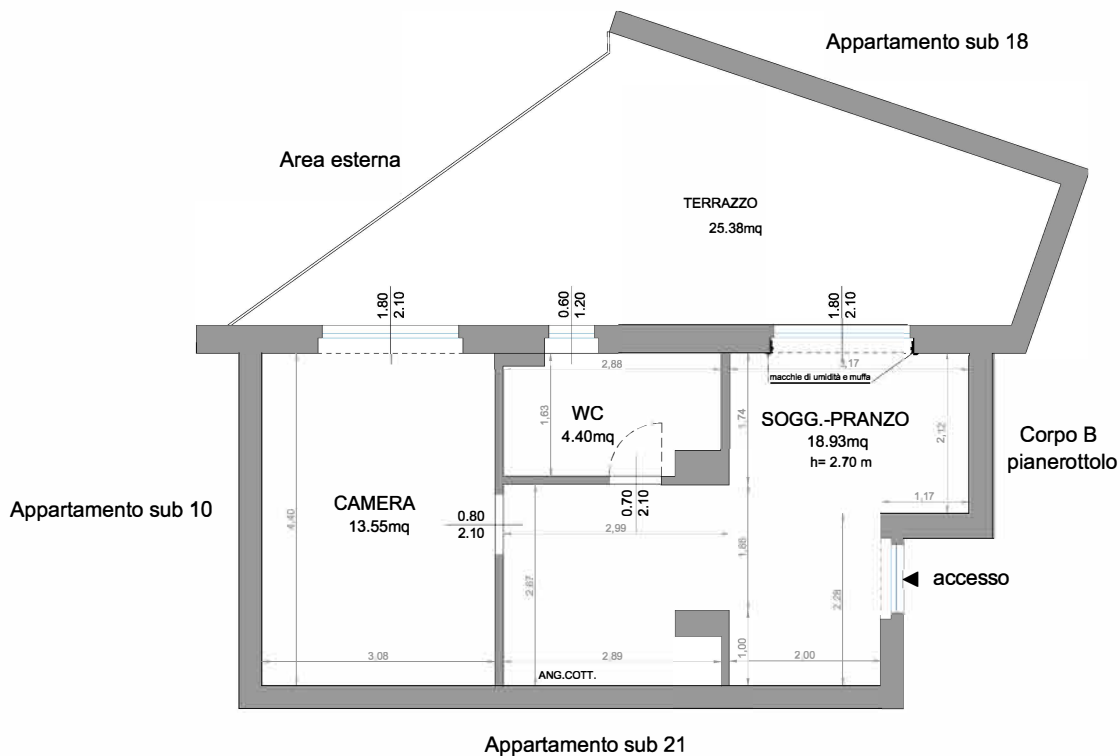

SCHEDA IMMOBILE											
N.	SOPRALLUOGO	DATA	SCALA	PIANO	SUB	CAT	RAPP.	SUP. NETTA	SUP. BALC.	SUP. OMI	SUP. Qmq
20	3	08.03.23	B	3	22	A/2	1:100	36.88 mq	25.38 mq	44.85 mq	43.06 mq
									30% SUP. BALC.	7.61 mq	
									25% SUP. BALC.		6.35 mq
									TOTALE	52.46 mq	49.41 mq

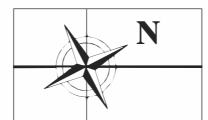

TRIBUNALE DI SALERNO - 3° SEZIONE CIVILE - E.I. N.
 260/2022 STATO DI FATTO - Proprietà (Omissis)
 Comune di Campagna (SA) - Via Calli - Corpo B - Piano 3°
 Catasto Fabbricati Foglio 77 part 1055 sub 24

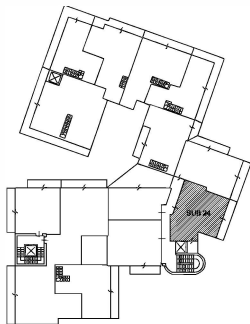
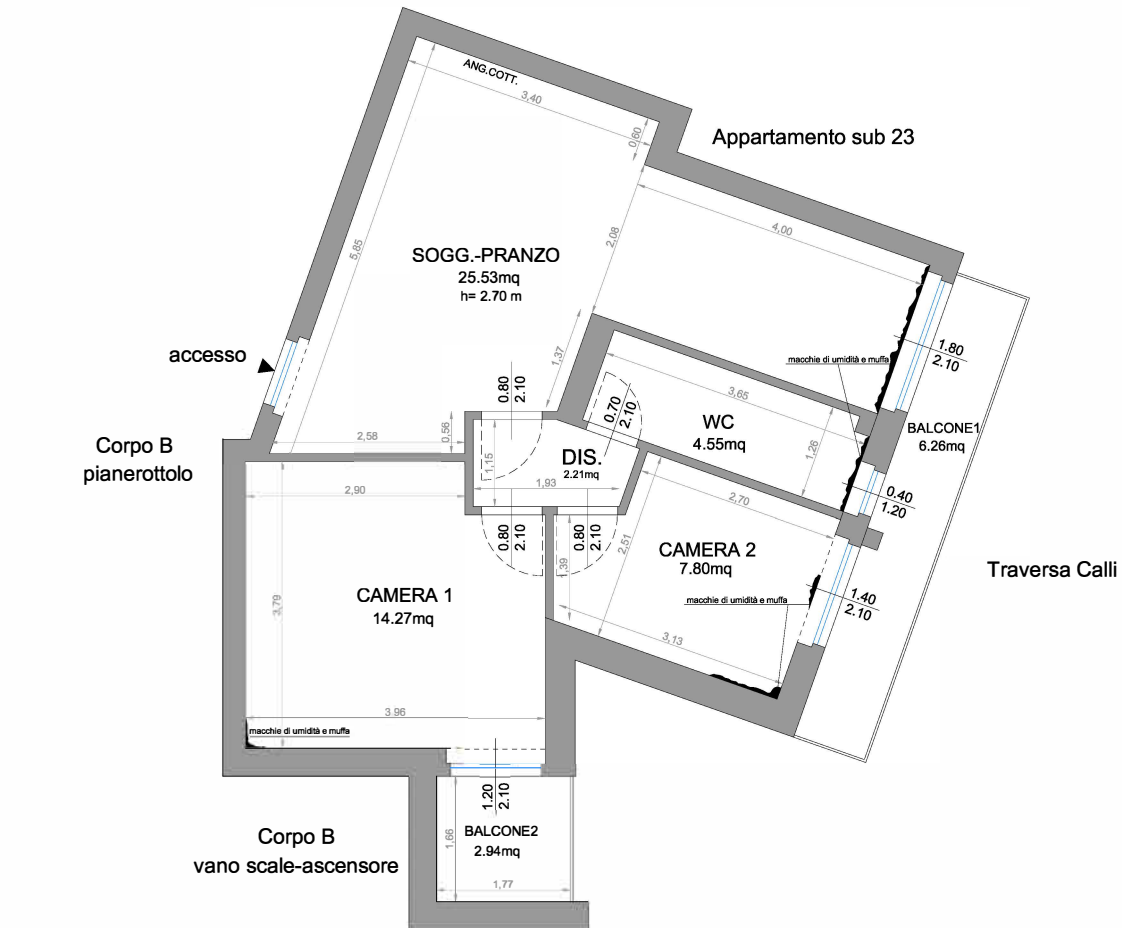

SCHEDA IMMOBILE

N.	SOPRALLUOGO	DATA	SCALA	PIANO	SUB	CAT	RAPP.	SUP. NETTA	SUP. BALC.	SUP. OMI	SUP. Qmq
21	5	22.03.23	B	3	24	A/2	1:100	54.36 mq	9.20 mq	64.56 mq	62.50 mq
									30% SUP. BALC.	2.76 mq	
									25% SUP. BALC.		2.30 mq
									TOTALE	67.32 mq	64.80 mq

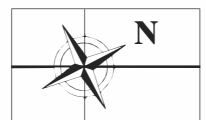

TRIBUNALE DI SALERNO - 3° SEZIONE CIVILE - E.I. N. 260/2022
 STATO DI FATTO - Proprietà (Omissis)
 Comune di Campagna (SA) - Via Calli - Corpo B - Piano 4° - 5° Sottotetto
 Catasto Fabbricati Foglio 77 part 1055 sub 25

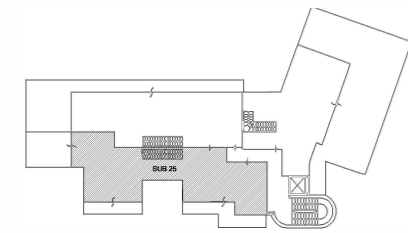
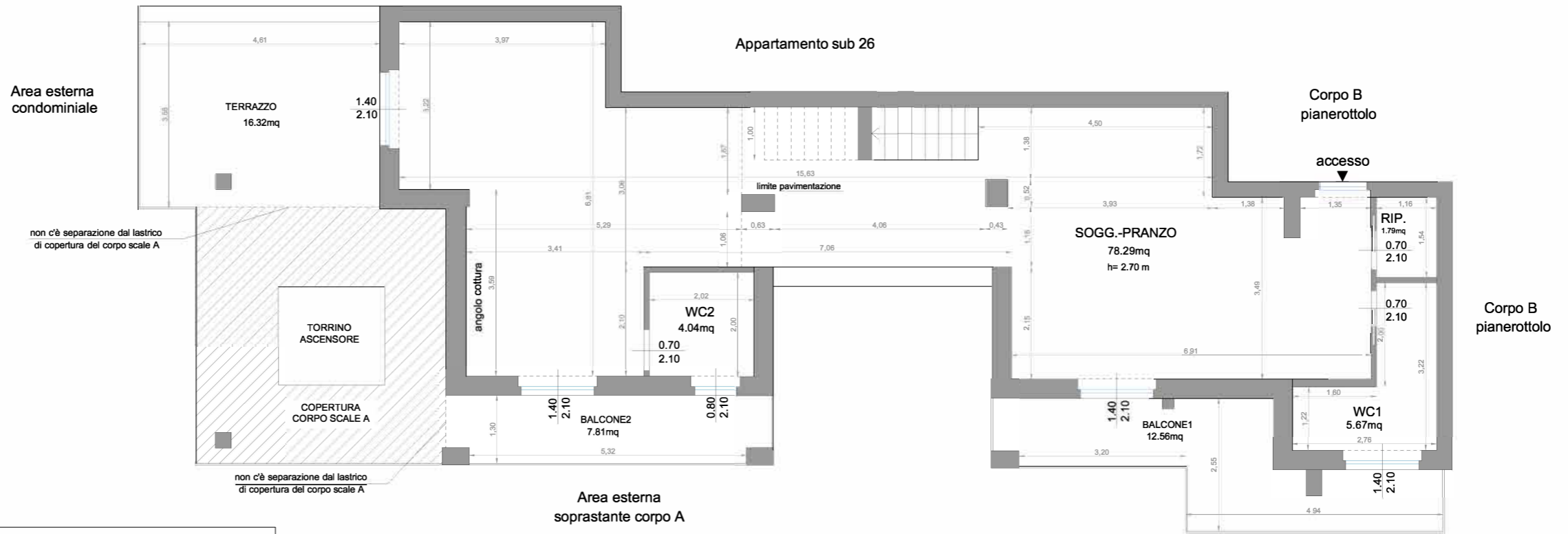

SCHEDA IMMOBILE											
N.	SOPRALLUOGO	DATA	SCALA	PIANO	SUB	CAT	RAPP.	SUP. NETTA	SUP. BALC.	SUP. OMI	SUP. Qmq
22A	11	21.09.23	B	4	25	A/2	1:100	81.90 mq	36.69 mq	107.70 mq	101.59 mq
									30% SUP. BALC.	11.00 mq	
									25% SUP. BALC.		9.17 mq
									TOTALE	118.70 mq	110.76 mq

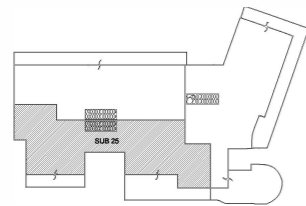
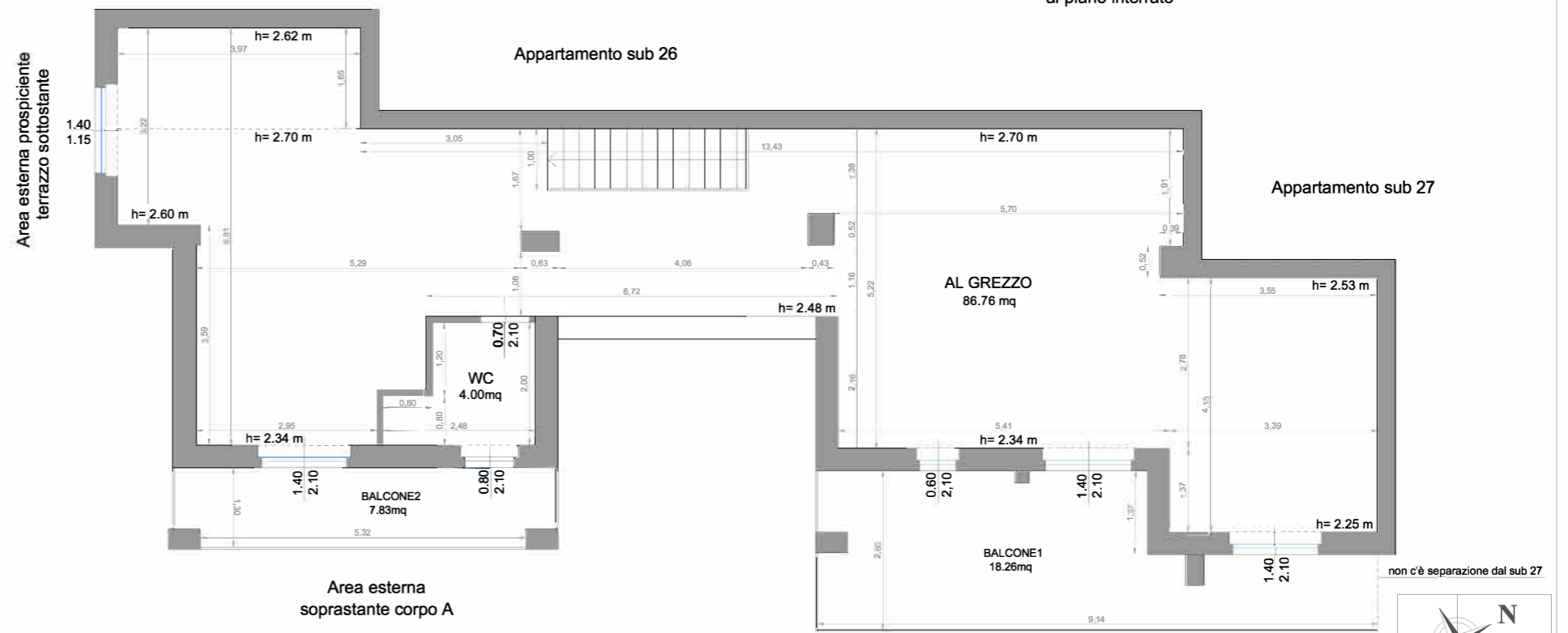

SCHEDA IMMOBILE											
N.	SOPRALLUOGO	DATA	SCALA	PIANO	SUB	CAT	RAPP.	SUP. NETTA	SUP. BALC.	SUP. OMI	SUP. Qmq
22B	11	21.09.23	B	5° SOTT.	25	A/2	1:100	90.67 mq	26.09 mq	111.94 mq	105.67 mq
									30% SUP. BALC.	7.83 mq	
									25% SUP. BALC.		6.52 mq
									TOTALE SOTTOTETTO	119.77 mq	112.19 mq
									SOTTOTETTO 50%	59.89 mq	56.10 mq
									TOTALE DUPLEX	178.62 mq	166.88 mq



TRIBUNALE DI SALERNO - 3° SEZIONE CIVILE - E.I. N. 260/2022
 STATO DI FATTO - Proprietà (Omissis)
 Comune di Campagna (SA) - Via Calli - Corpo B - Piano 4°- 5° Sottotetto
 Catasto Fabbricati Foglio 77 part 1055 sub 26

Area esterna

Area esterna condominiale

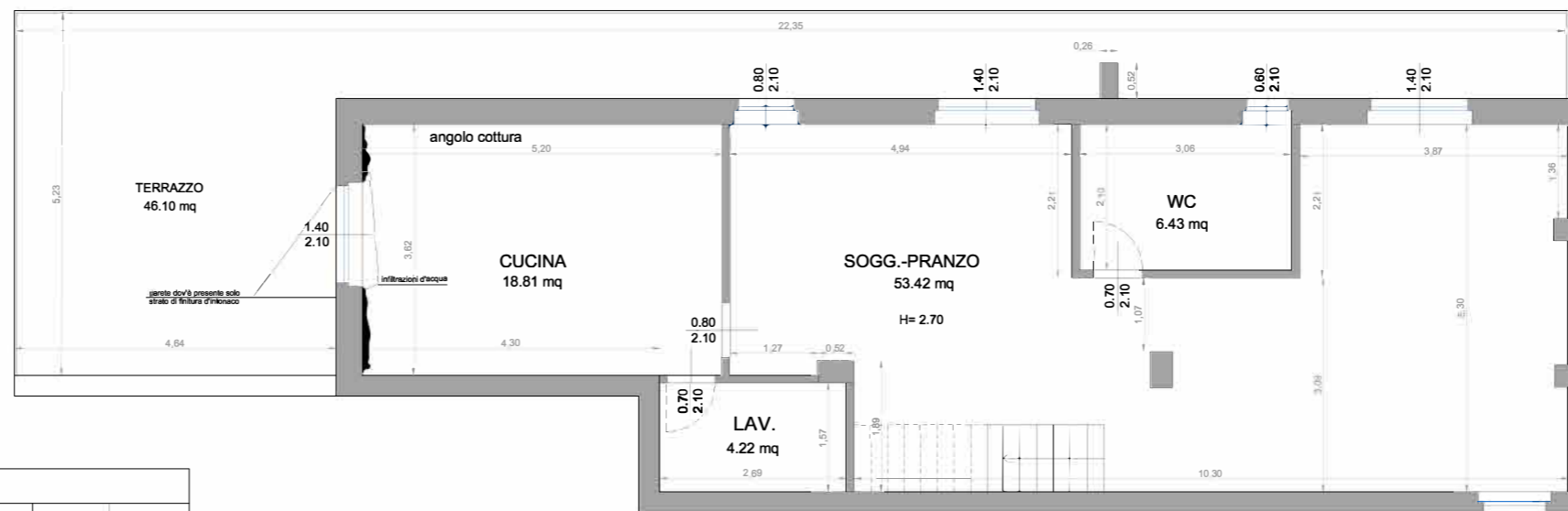

Appartamento sub 27

Appartamento sub 25

accesso
Corpo B
pianerotolo

SCHEDA IMMOBILE

N.	SOPRALLUOGO	DATA	SCALA	PIANO	SUB	CAT	RAPP.	SUP. NETTA	SUP. BALC.	SUP. OMI	SUP. Qmq
23A	1	22.02.23	B	4	26	A/2	1:100	82.88 mq	46.10 mq	96.69 mq	92.64 mq
									30%SUP. BALC. 10%OLTRE 25 MQ.	9.61 mq	
									25%SUP. BALC.		11.53 mq
								TOTALE		106.30 mq	104.17 mq

Area esterna

Area esterna prospiciente
terrazzo sottostante

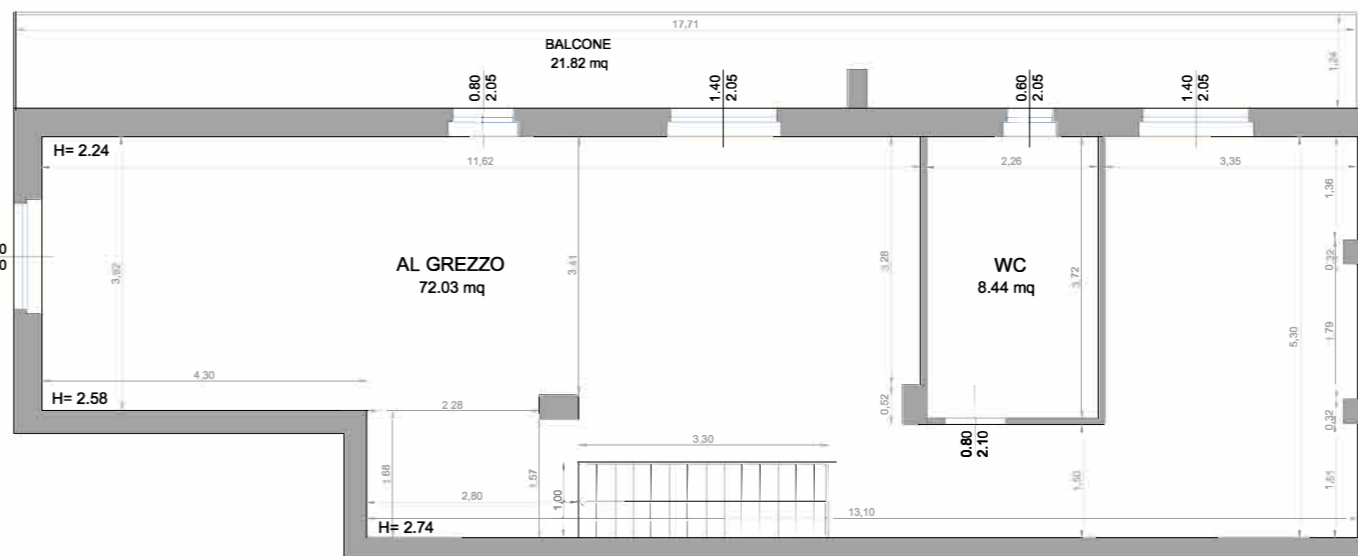

Appartamento sub 27

Appartamento sub 25

SCHEDA IMMOBILE

N.	SOPRALLUOGO	DATA	SCALA	PIANO	SUB	CAT	RAPP.	SUP. NETTA	SUP. BALC.	SUP. OMI	SUP. Qmq
23B	1	22.02.23	B	SOTT.	26	A/2	1:100	80.47 mq	21.82 mq	96.69 mq	92.64 mq
									30%SUP. BALC.	6.55 mq	
									25%SUP. BALC.		5.46mq
								TOTALE SOTTOTETTO		103.24 mq	98.10 mq
								SOTTOTETTO 50%		51.62 mq	49.05 mq
								TOTALE DUPLEX		162.14 mq	153.22 mq



TRIBUNALE DI SALERNO - 3° SEZIONE CIVILE - E.I. N. 260/2022
 STATO DI FATTO - Proprietà (Omissis)
 Comune di Campagna (SA) - Via Calli - Corpo B - Piano 4°- 5° Sottotetto
 Catasto Fabbricati Foglio 77 part 1055 sub 27

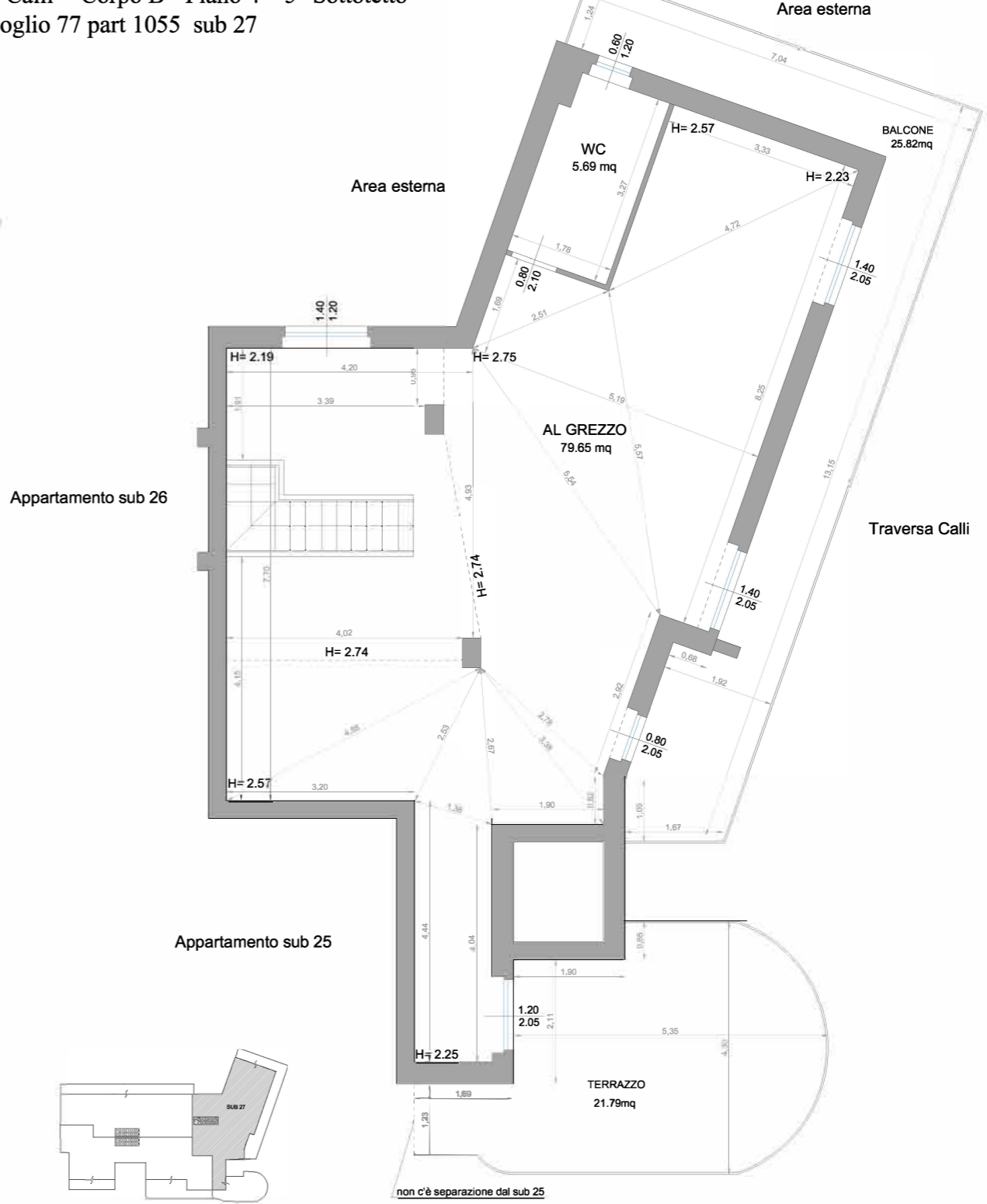

SCHEDA IMMOBILE											
N.	SOPRALLUOGO	DATA	SCALA	PIANO	SUB	CAT	RAPP.	SUP. NETTA	SUP. BALC.	SUP. OMI	SUP. Qmq
24A	1	22.02.23	B	4	27	A/2	1:100	72.99 mq	106.49 mq	86.56 mq	81.32 mq
									30% SUP. BALC. 0% SOLT. REMQ.	15.65 mq	
									25% SUP. BALC.		26.62mq
								TOTALE		102.21 mq	107.94 mq

SCHEDA IMMOBILE											
N.	SOPRALLUOGO	DATA	SCALA	PIANO	SUB	CAT	RAPP.	SUP. NETTA	SUP. BALC.	SUP. OMI	SUP. Qmq
24B	1	22.02.23	B	4	27	A/2	1:100	85.34 mq	47.61 mq	104.82 mq	98.88 mq
									30% SUP. BALC.	14.28 mq	
									25% SUP. BALC.		11.90mq
								TOTALE SOTTOTETTO		119.10 mq	110.78 mq
								SOTTOTETTO 50%		59.55 mq	55.36 mq
								TOTALE DUPLEX		178.06 mq	163.41 mq

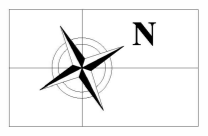

RILIEVI DELLO STATO DI FATTO

FABBRICATO SITO IN CAMPAGNA (SA) VIA CALLI – FOGLIO 77 PART. 1055

ELENCO IMMOBILI:

CORPO C

25-SUB 28

26-SUB 29

27-SUB 35

28-SUB 36

29-SUB 31

30-SUB 74

31-SUB 75

32-SUB 76

TRIBUNALE DI SALERNO - 3° SEZIONE CIVILE - E.I. N.
 260/2022 STATO DI FATTO - Proprietà (Omissis)
 Comune di Campagna (SA) - Via Calli - Corpo C - Piano 1°
 Catasto Fabbricati Foglio 77 part 1055 sub 28

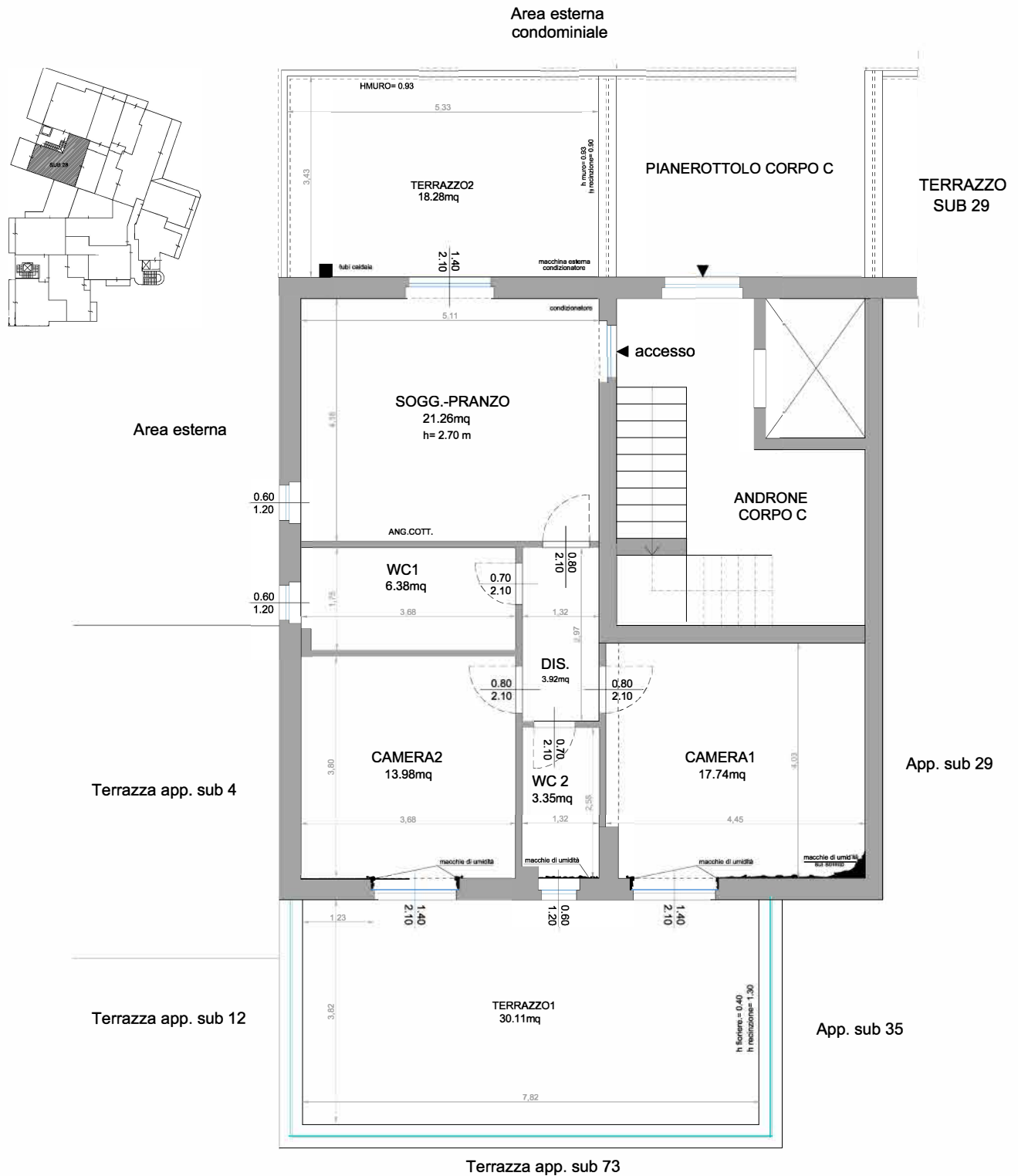

SCHEDA IMMOBILE											
N.	SOPRALLUOGO	DATA	SCALA	PIANO	SUB	CAT	RAPP.	SUP. NETTA	SUP. BALC.	SUP. OMI	SUP. Qmq
25	7	05.04.23	C	1	28	A/2	1:100	66.63 mq	48.39 mq	80.25 mq	75.44 mq
									30% SUP. BALC. 10% OLTRE 25 MQ.	13.49 mq	
									25% SUP. BALC.		12.10 mq
									TOTALE	93.74 mq	87.54 mq



TRIBUNALE DI SALERNO - 3° SEZIONE CIVILE - E.I. N.
260/2022 STATO DI FATTO - Proprietà (Omissis)
Comune di Campagna (SA) - Via Calli - Corpo C - Piano 1°
Catasto Fabbricati Foglio 77 part 1055 sub 29

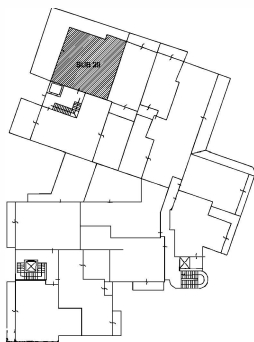
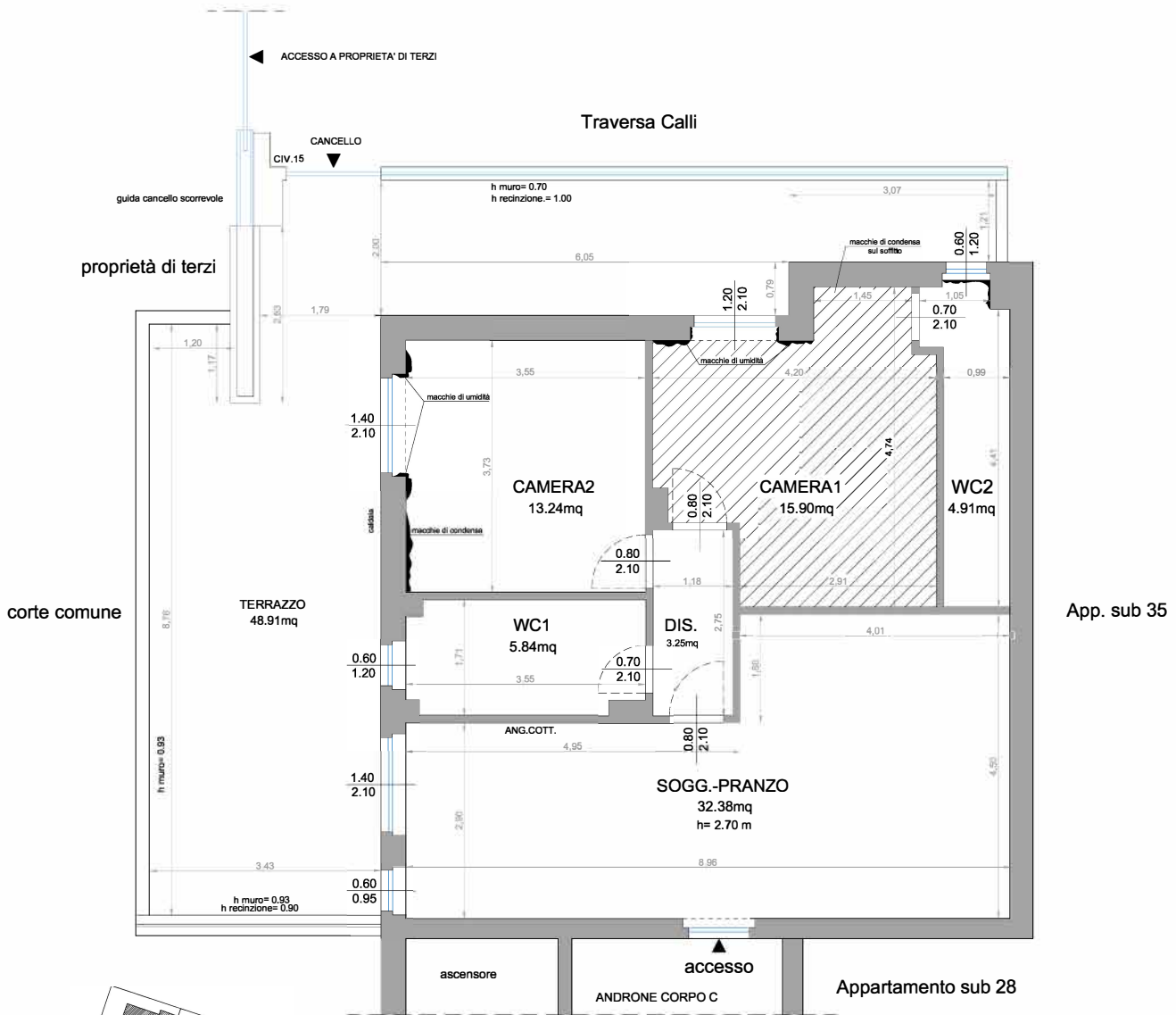

SCHEDA IMMOBILE

N.	SOPRALLUOGO	DATA	SCALA	PIANO	SUB	CAT	RAPP.	SUP. NETTA	SUP. BALC.	SUP. OMI	SUP. Qmq	
26	7	05.04.23	C	1	29	A/2	1:100	75.52 mq	48.91 mq	89.13 mq	85.58 mq	
										30% SUP. BALC. 10% OLTRE 25 MQ	9.89 mq	
										25% SUP. BALC.		12.22 mq
										TOTALE	99.02 mq	97.80 mq



TRIBUNALE DI SALERNO - 3° SEZIONE CIVILE - E.I. N.
 260/2022 STATO DI FATTO - Proprietà (Omissis)
 Comune di Campagna (SA) - Via Calli - Corpo C - Piano 1°
 Catasto Fabbricati Foglio 77 part 1055 sub 36

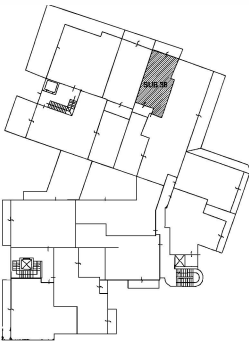
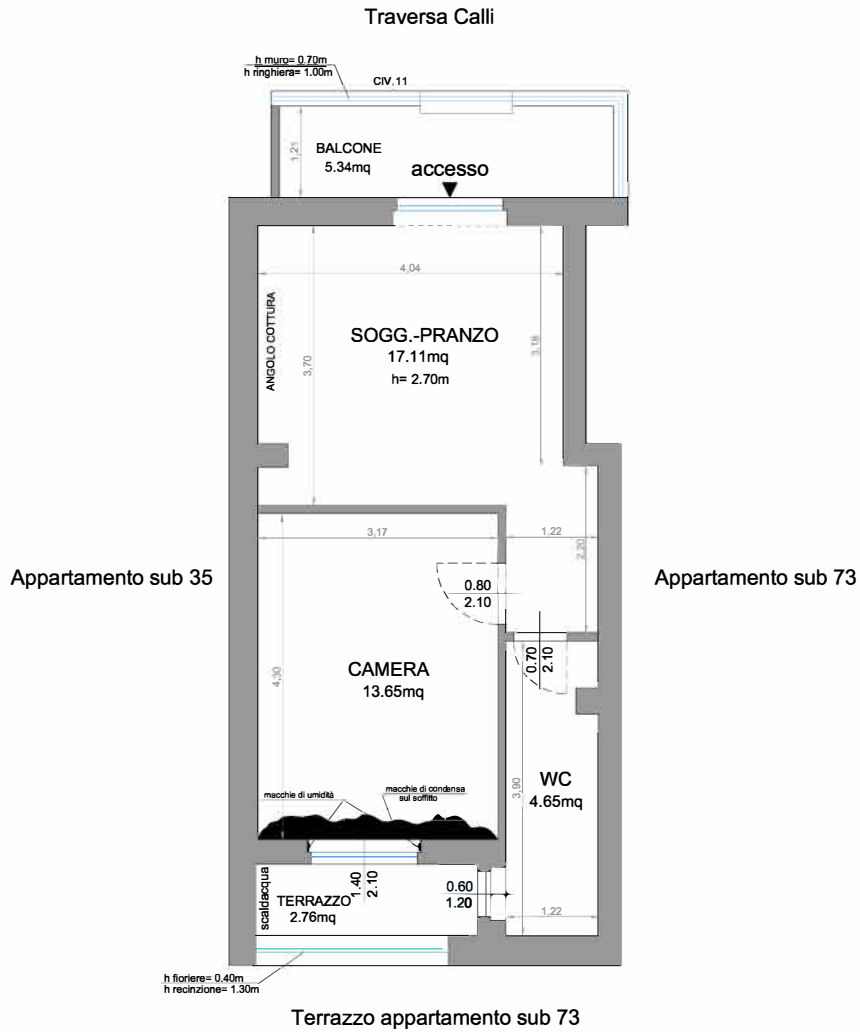

SCHEDA IMMOBILE

N.	SOPRALLUOGO	DATA	SCALA	PIANO	SUB	CAT	RAPP.	SUP. NETTA	SUP. BALC.	SUP. OMI	SUP. Qmq
28	7	05.04.23	C	1	36	A/2	1:100	35.41 mq	8.10 mq	43.18 mq	41.59 mq
										30%SUP. BALC. 2.43 mq	
										25%SUP. BALC.	2.03 mq
										TOTALE	45.61 mq
											43.62 mq



TRIBUNALE DI SALERNO - 3° SEZIONE CIVILE - E.I. N. 260/2022
 STATO DI FATTO - Proprietà (Omissis)
 Comune di Campagna (SA) - Via Calli - Corpo C - Piano 2°- 3° Sottotetto
 Catasto Fabbricati Foglio 77 part 1055 sub 31

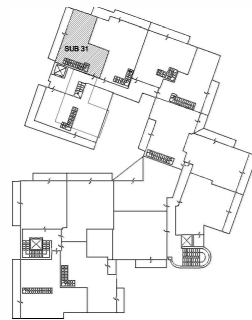
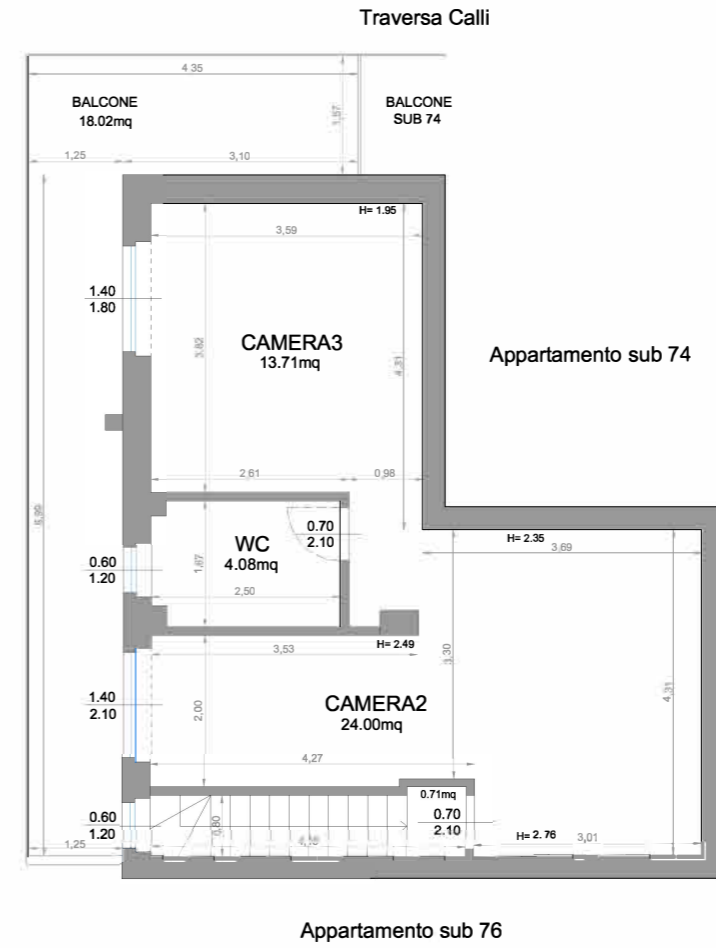
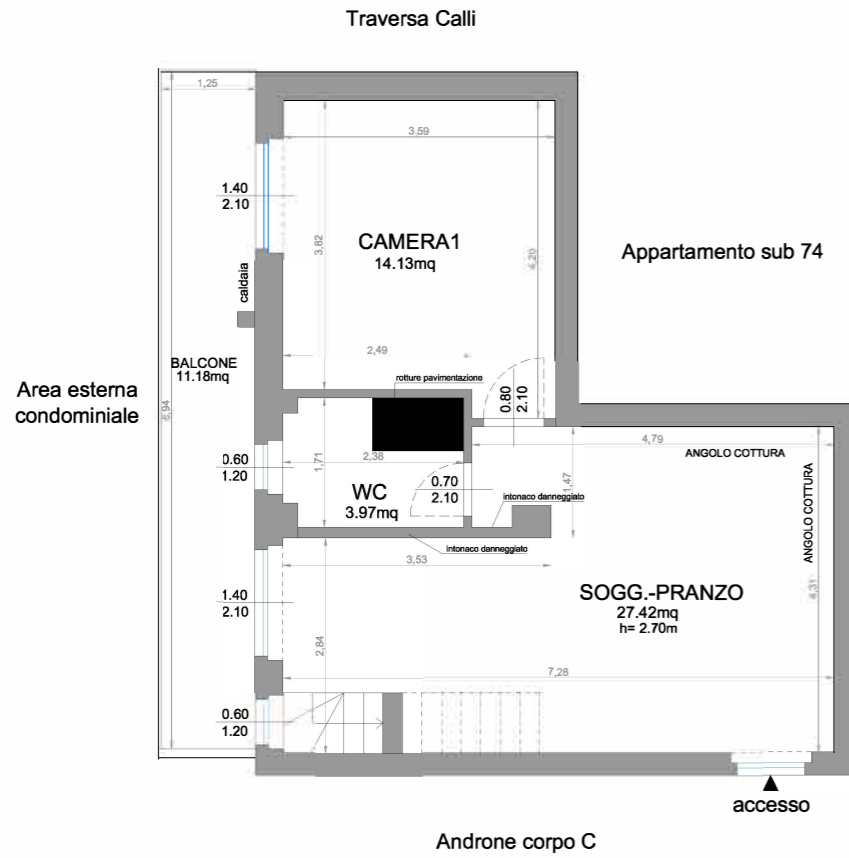

SCHEDA IMMOBILE											
N.	SOPRALLUOGO	DATA	SCALA	PIANO	SUB	CAT	RAPP.	SUP. NETTA	SUP. BALC.	SUP. OMI	SUP. Qmq
29A	3	08.03.23	C	2	31	A/2	1:100	45.52 mq	11.18 mq	54.60 mq	52.17 mq
								30%SUP. BALC.	3.35 mq		
								25%SUP. BALC.		2.80 mq	
								TOTALE	57.95 mq	54.97 mq	

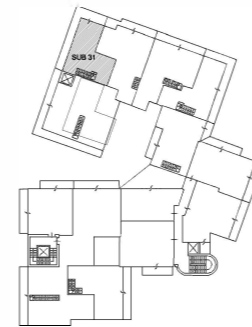

SCHEDA IMMOBILE											
N.	SOPRALLUOGO	DATA	SCALA	PIANO	SUB	CAT	RAPP.	SUP. NETTA	SUP. BALC.	SUP. OMI	SUP. Qmq
29B	3	08.03.23	C	SOTT.	31	A/2	1:100	42.50 mq	18.02 mq	54.60 mq	52.17 mq
								30%SUP. BALC.	5.41 mq		
								25%SUP. BALC.		4.51 mq	
								TOTALE SOTTOTETTO	60.01 mq	56.68 mq	
								SOTTOTETTO 50%	30.01 mq	28.34 mq	
								TOTALE DUPLEX	87.96 mq	83.31 mq	



TRIBUNALE DI SALERNO - 3° SEZIONE CIVILE - E.I. N. 260/2022
 STATO DI FATTO - Proprietà (Omissis)
 Comune di Campagna (SA) - Via Calli - Corpo C - Piano 2° e 3° Sottotetto
 Catasto Fabbricati Foglio 77 part 1055 sub 74 (ex sub 32)

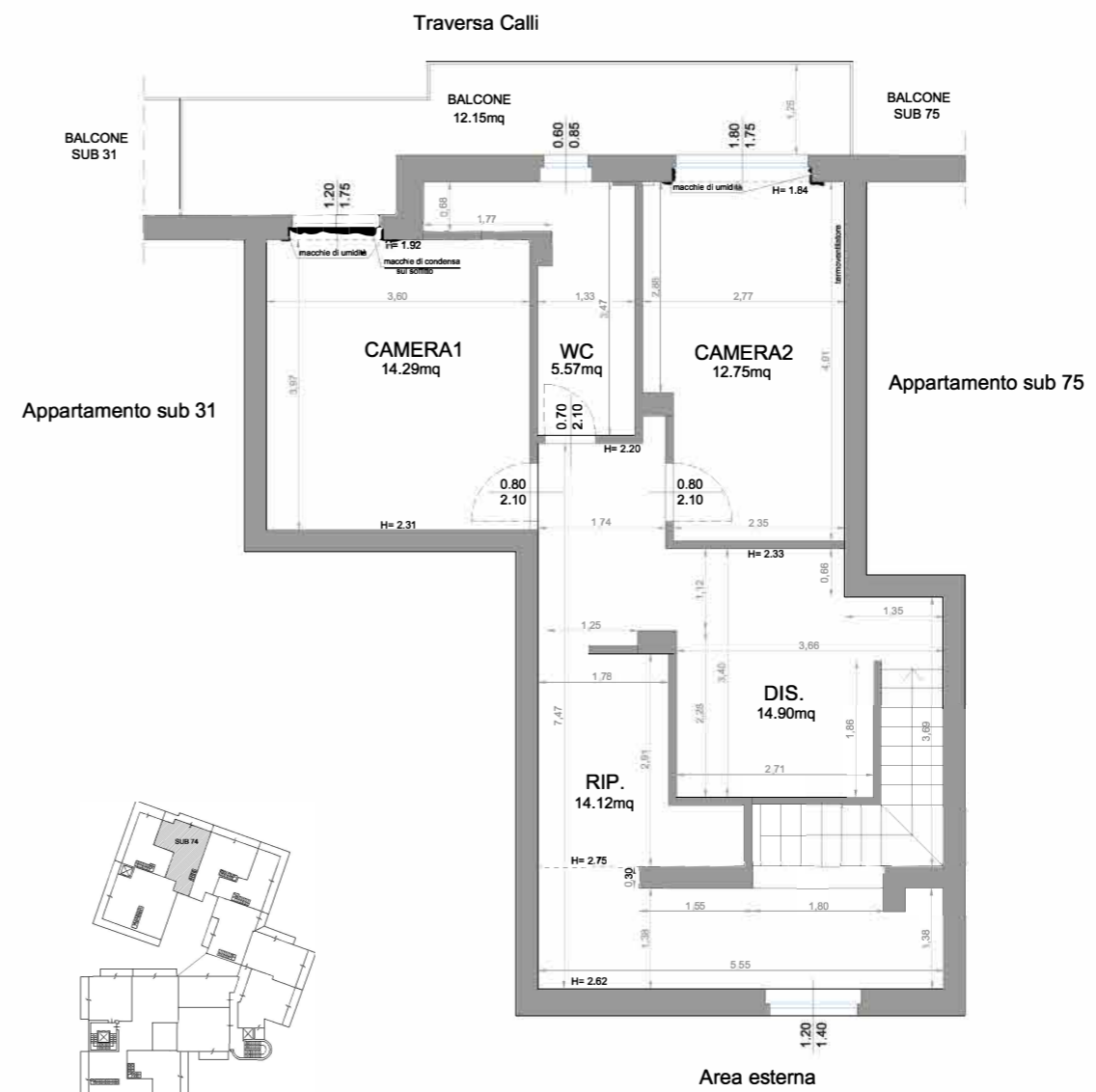
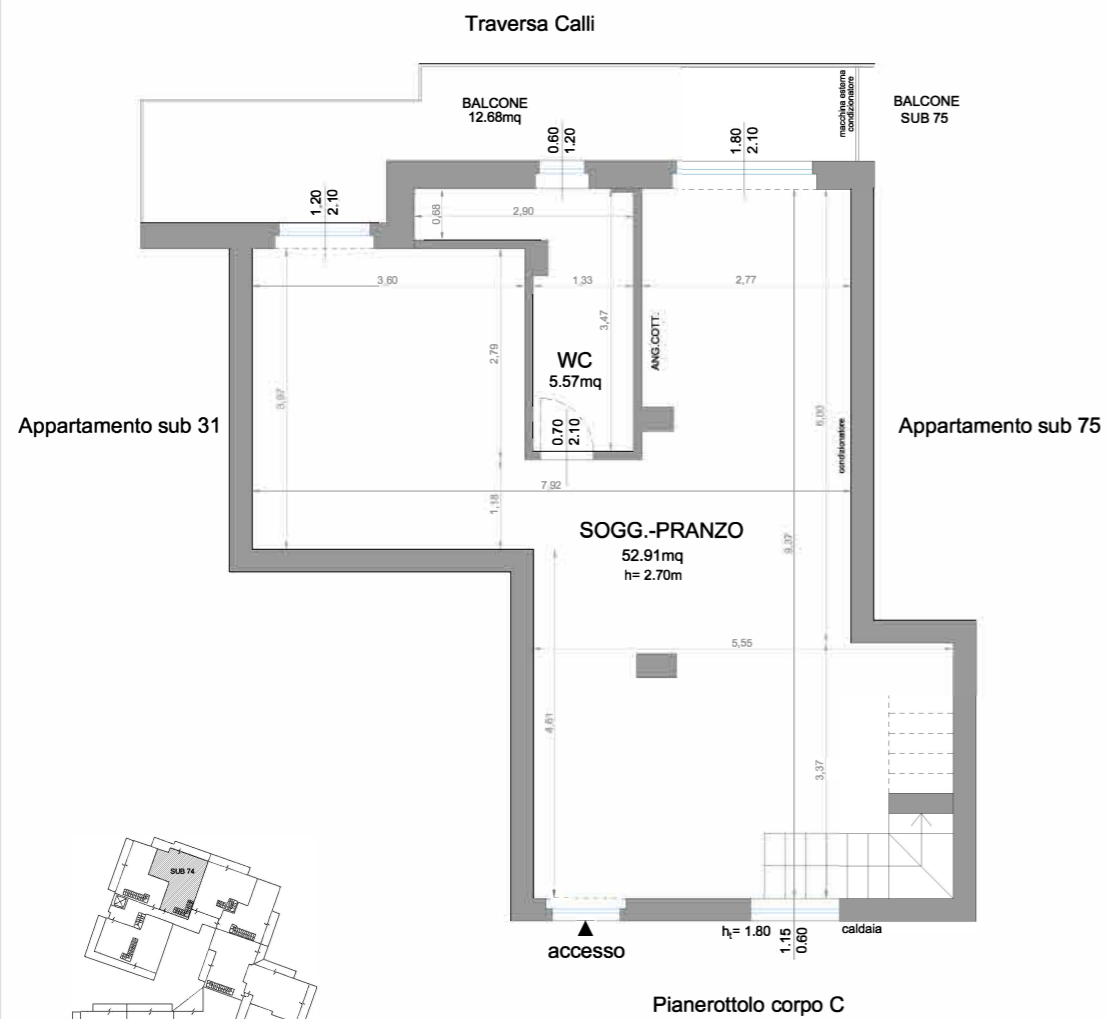

SCHEDA IMMOBILE											
N.	SOPRALLUOGO	DATA	SCALA	PIANO	SUB	CAT	RAPP.	SUP. NETTA	SUP. BALC.	SUP. OMI	SUP. Qmq
30A	6	29.03.23	C	2	74	A/2	1:100	58.48 mq	12.68 mq	67.52 mq	65.85 mq
								30%SUP. BALC.	3.80 mq		
								25%SUP. BALC.		3.17 mq	
								TOTALE	71.32 mq	69.02mq	

SCHEDA IMMOBILE											
N.	SOPRALLUOGO	DATA	SCALA	PIANO	SUB	CAT	RAPP.	SUP. NETTA	SUP. BALC.	SUP. OMI	SUP. Qmq
30B	6	29.03.23	C	SOTT.	74	A/2	1:100	61.63 mq	12.15 mq	79.07 mq	76.32 mq
								30%SUP. BALC.	3.65 mq		
								25%SUP. BALC.		3.04 mq	
								TOTALE SOTTOTETTO	82.72 mq	79.36 mq	
								SOTTOTETTO 50%	41.36 mq	39.68 mq	
								TOTALE DUPLEX	112.68 mq	108.70 mq	



TRIBUNALE DI SALERNO - 3° SEZIONE CIVILE - E.I. N. 260/2022
 STATO DI FATTO - Proprietà (Omissis)
 Comune di Campagna (SA) - Via Calli - Corpo C - Piano 2° e 3° Sottotetto
 Catasto Fabbricati Foglio 77 part 1055 sub 75 (ex sub 33)

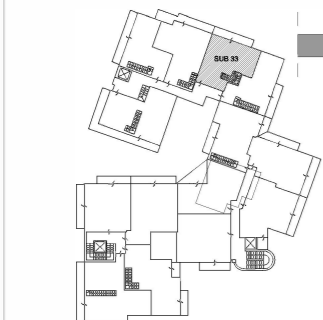
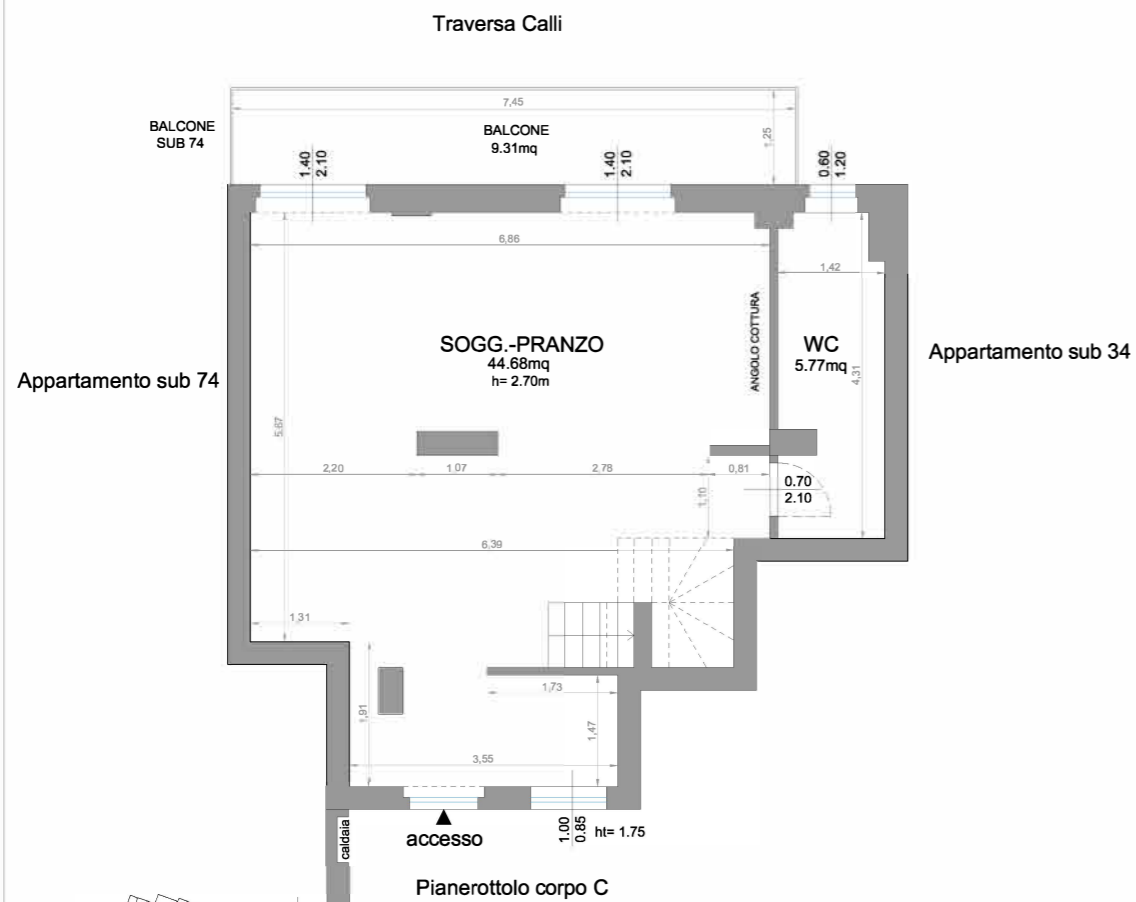

SCHEDA IMMOBILE											
N.	SOPRALLUOGO	DATA	SCALA	PIANO	SUB	CAT	RAPP.	SUP. NETTA	SUP. BALC.	SUP. OMI	SUP. Qmq
31A	2	01.03.23	C	2	75	A/2	1:100	50.45mq	9.31 mq	58.81mq	57.15 mq
									30%SUP. BALC.	2.79 mq	
									25%SUP. BALC.		2.33 mq
									TOTALE	61.60 mq	59.48 mq

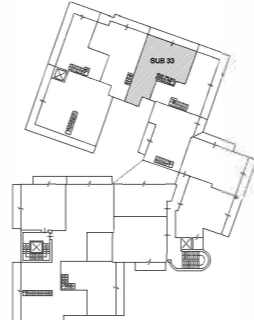
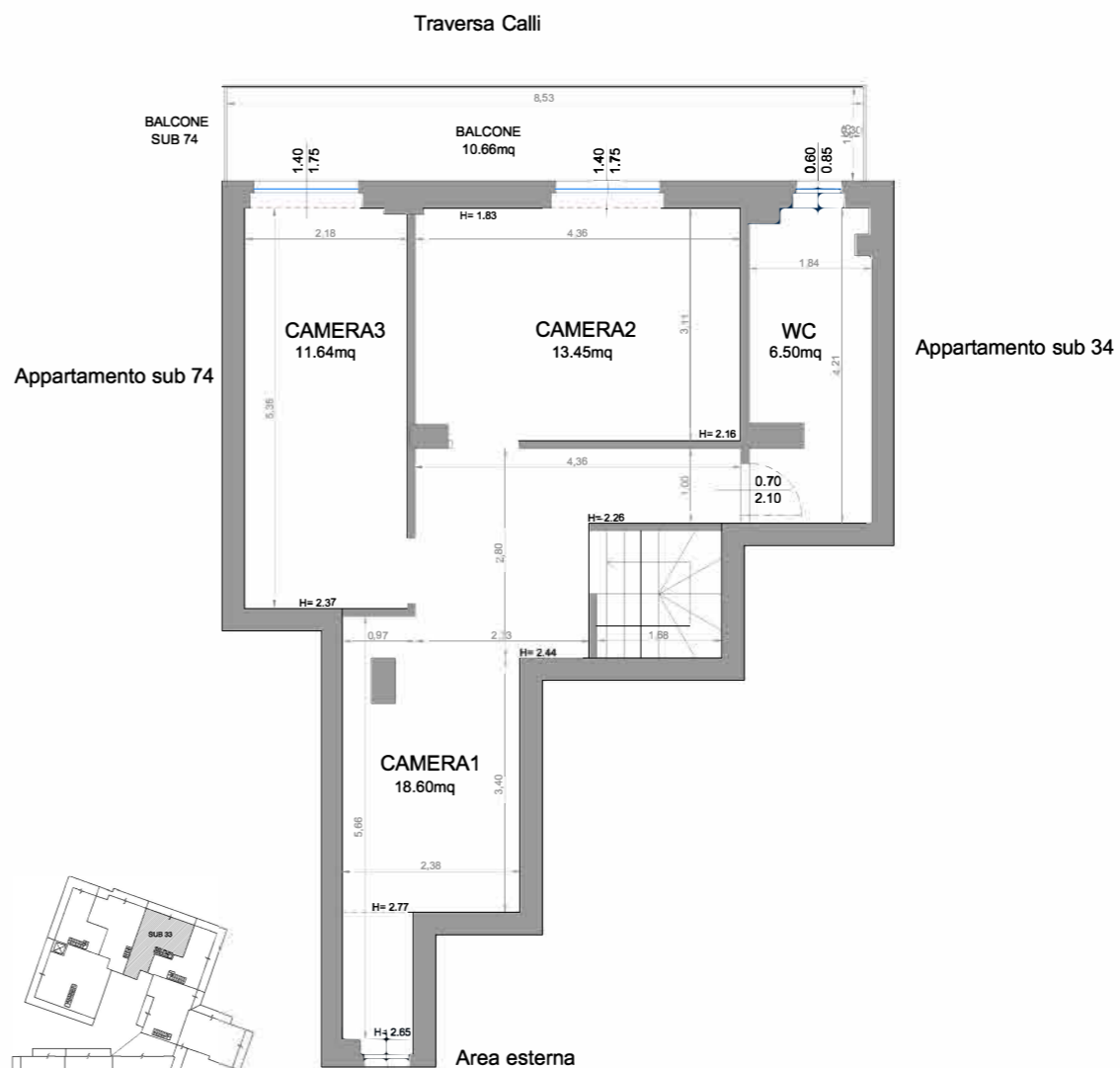

SCHEDA IMMOBILE											
N.	SOPRALLUOGO	DATA	SCALA	PIANO	SUB	CAT	RAPP.	SUP. NETTA	SUP. BALC.	SUP. OMI	SUP. Qmq
31B	2	01.03.23	C	SOTT.	75	A/2	1:50	50.19 mq	10.66 mq	64.23mq	61.89 mq
									30%SUP. BALC.	3.20 mq	
									25%SUP. BALC.		2.67 mq
									TOTALE SOTTOTETTO	67.43 mq	64.56 mq
									SOTTOTETTO 50%	33.72 mq	32.28 mq
									TOTALE DUPLEX	95.32 mq	91.76 mq

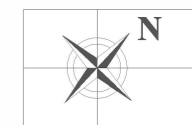

TRIBUNALE DI SALERNO - 3° SEZIONE CIVILE - E.I. N. 260/2022

STATO DI FATTO - Proprietà (Omissis)

Comune di Campagna (SA) - Via Calli - Corpo C - Piano 2° e 3° Sottotetto

Catasto Fabbricati Foglio 77 part 1055 sub 76 (ex sub 30)

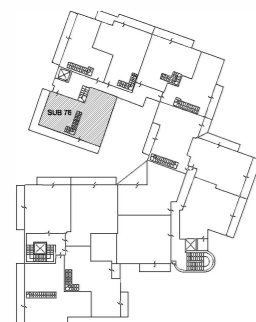
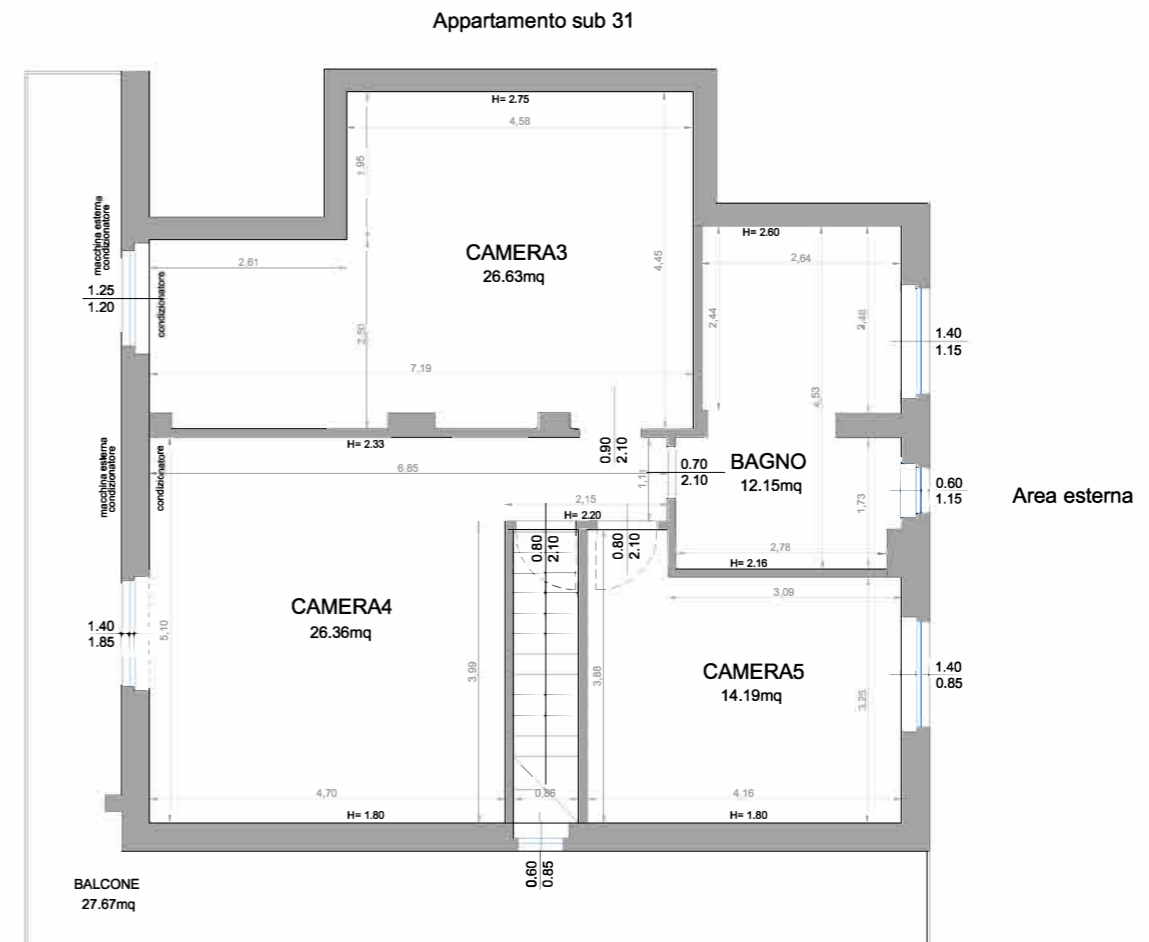
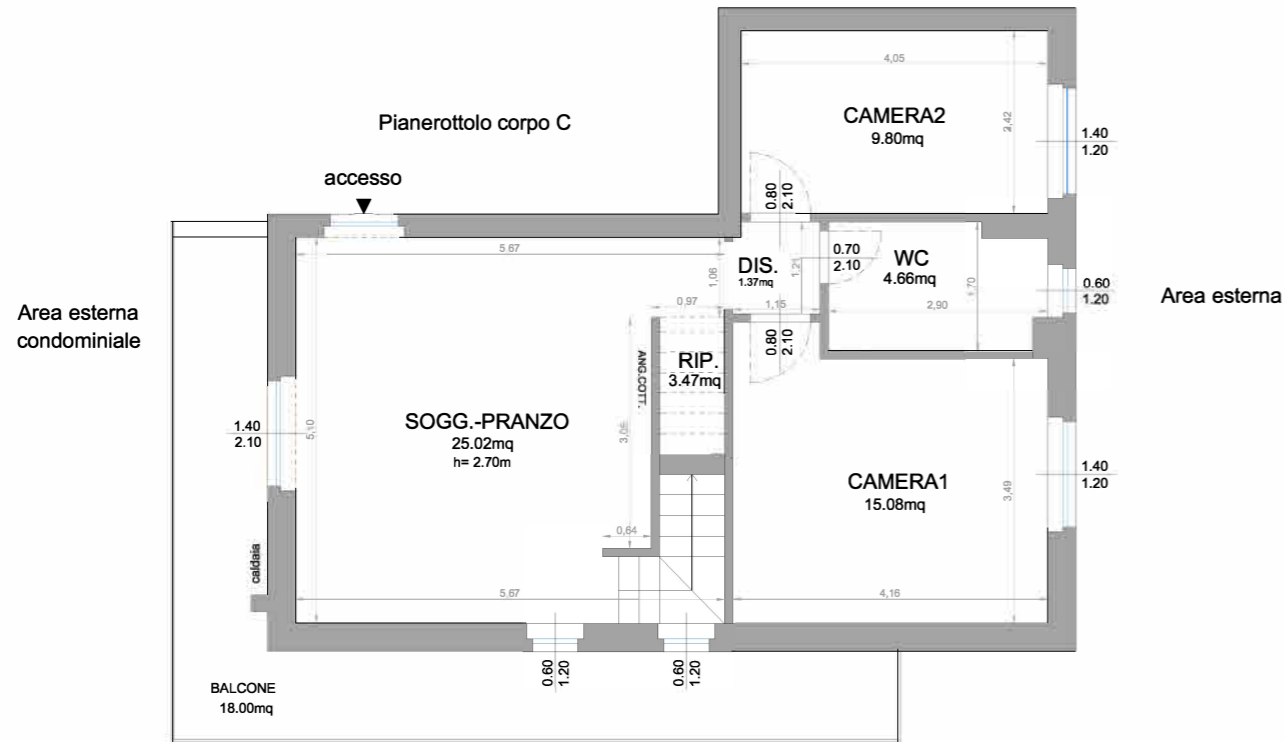

SCHEDA IMMOBILE											
N.	SOPRALLUOGO	DATA	SCALA	PIANO	SUB	CAT	RAPP.	SUP. NETTA	SUP. BALC.	SUP. OMI	SUP. Qmq
32A	5	22.03.23	C	2	76	A/2	1:100	59.40 mq	18.00 mq	72.50 mq	68.00 mq
									30%SUP. BALC.	5.40mq	
									25%SUP. BALC.		4.50mq
								TOTALE	77.90 mq	72.50 mq	

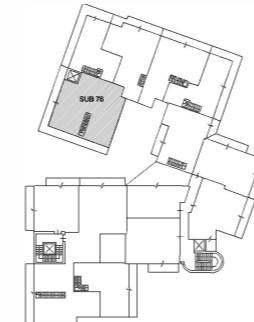

SCHEDA IMMOBILE											
N.	SOPRALLUOGO	DATA	SCALA	PIANO	SUB	CAT	RAPP.	SUP. NETTA	SUP. BALC.	SUP. OMI	SUP. Qmq
32B	5	22.03.23	C	SOTT.	76	A/2	1:100	79.33 mq	27.67 mq	97.95 mq	92.96 mq
									30%SUP. BALC.	7.77 mq	
									10%OLTRE 25 MQ.		6.92 mq
									25%SUP. BALC.		
								TOTALE SOTTOTETTO	105.72 mq	99.88 mq	
								SOTTOTETTO 50%	52.86 mq	49.94 mq	
								TOTALE DUPLEX	130.76 mq	122.40 mq	

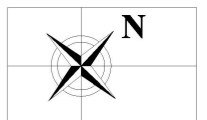

RILIEVI DELLO STATO DI FATTO

FABBRICATO SITO IN CAMPAGNA (SA) VIA CALLI – FOGLIO 77 PART. 1055

ELENCO IMMOBILI:

PIANO INTERRATO BOX AUTO

33-SUB 38

34-SUB 39

35-SUB 40

36-SUB 41

37-SUB 42

38-SUB 43

39-SUB 45

40-SUB 46

41-SUB 47

42-SUB 48

43-SUB 49

44-SUB 50

45-SUB 51

46-SUB 52

47-SUB 53

48-SUB 54

49-SUB 55

50-SUB 56

51-SUB 57

52-SUB 58

53-SUB 59

54-SUB 60

55-SUB 61

56-SUB 62

57-SUB 64

TRIBUNALE DI SALERNO - 3° SEZIONE CIVILE - E.I. N.
 260/2022 STATO DI FATTO - Proprietà (Omissis)
 Comune di Campagna (SA) - Via Calli - Corpo A - Piano Interrato
 Catasto Fabbricati Foglio 77 part 1055 sub 38

Box auto sub 39

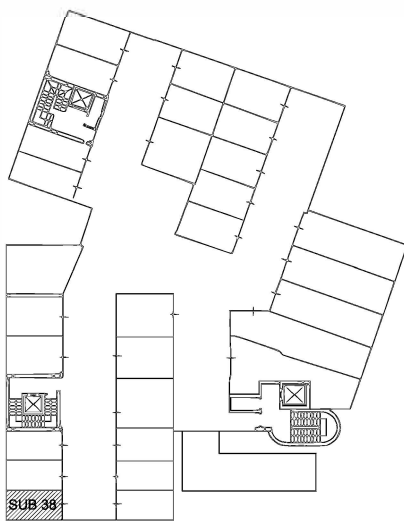
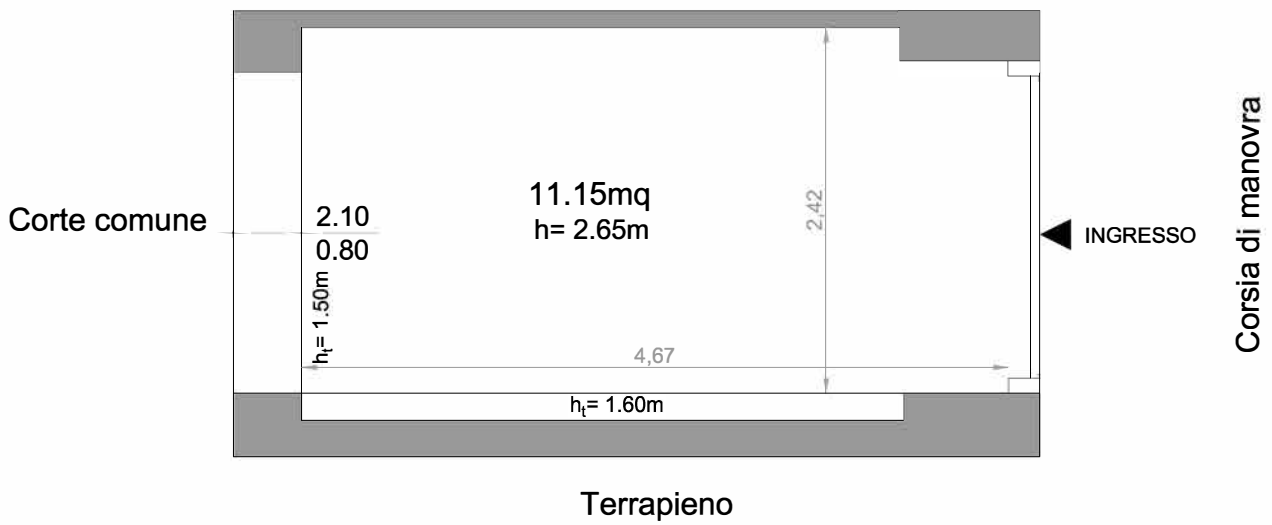

SCHEDA IMMOBILE											
N.	SOPRALLUOGO	DATA	SCALA	PIANO	SUB	CAT	RAPP.	SUP. NETTA	SUP. BALC.	SUP. OMI	SUP. Qmq
33	4	15.03.23	/	INTER.	38	C/6	1:50	11.15 mq	/	14.50 mq	13.88 mq



TRIBUNALE DI SALERNO - 3° SEZIONE CIVILE - E.I. N. 260/2022
 STATO DI FATTO - Proprietà (Omissis)
 - Comune di Campagna (SA) - Via Calli - Corpo A - Piano Interrato
 Catasto Fabbricati Foglio 77 part 1055 sub 39

Box auto sub 40



Box auto sub 38

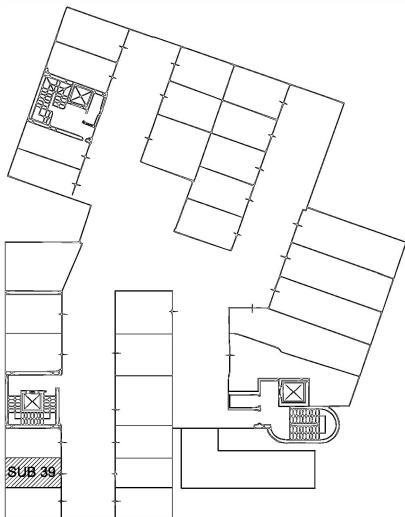

SCHEDA IMMOBILE											
N.	SOPRALLUOGO	DATA	SCALA	PIANO	SUB	CAT	RAPP.	SUP. NETTA	SUP. BALC.	SUP. OMI	SUP. Qmq
34	4	05.04.23	/	INTER.	39	C/6	1:50	12.22 mq	/	14.32 mq	13.70 mq



TRIBUNALE DI SALERNO - 3° SEZIONE CIVILE - E.I. N.
 260/2022 STATO DI FATTO - Proprietà (Omissis)
 Comune di Campagna (SA) - Via Calli - Corpo A - Piano Interrato
 Catasto Fabbricati Foglio 77 part 1055 sub 40

Vano Scale corpo A

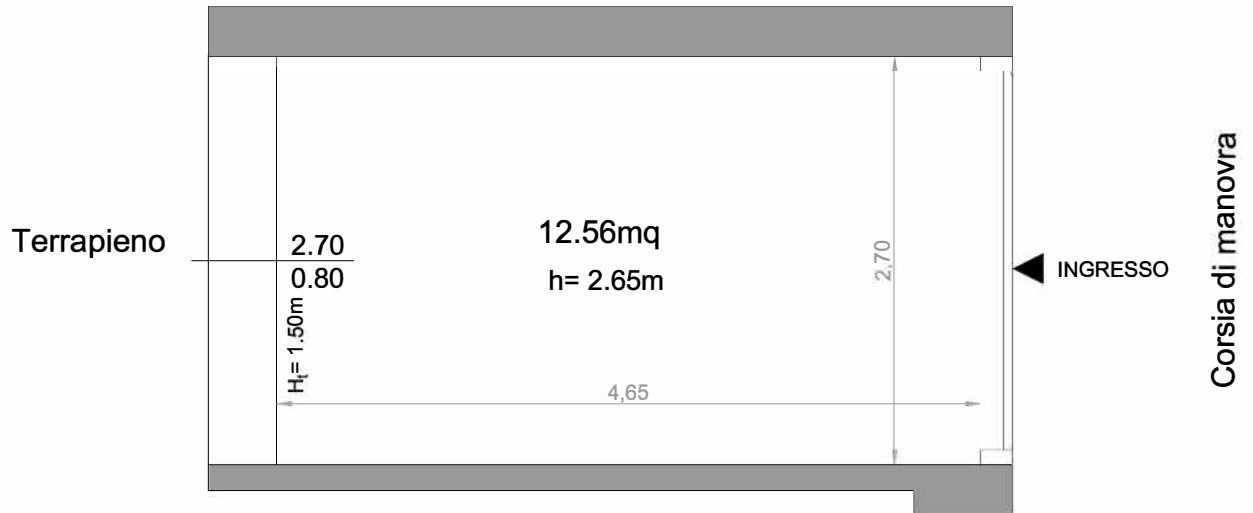

Box auto sub 39

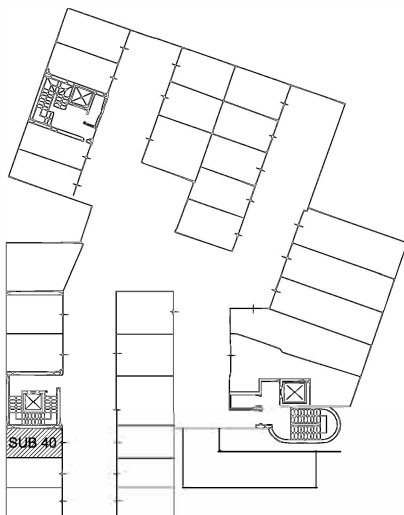

SCHEDA IMMOBILE											
N.	SOPRALLUOGO	DATA	SCALA	PIANO	SUB	CAT	RAPP.	SUP. NETTA	SUP. BALC.	SUP. OMI	SUP. Qmq
35	4	15.03.23	/	INTER.	40	C/6	1:50	12.56 mq	/	15.35 mq	14.69 mq



TRIBUNALE DI SALERNO - 3° SEZIONE CIVILE - E.I. N.
 260/2022 STATO DI FATTO - Proprietà (Omissis)
 Comune di Campagna (SA) - Via Calli - Corpo A - Piano Interrato
 Catasto Fabbricati Foglio 77 part 1055 sub 41

Box auto sub 42

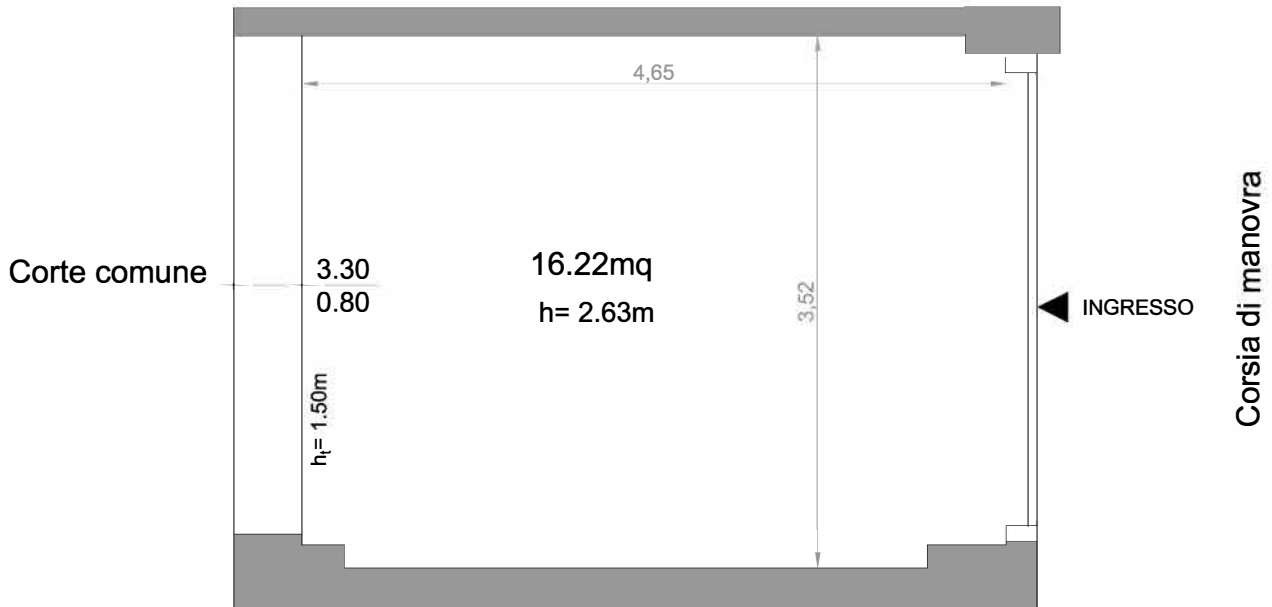

Vano Scale corpo A

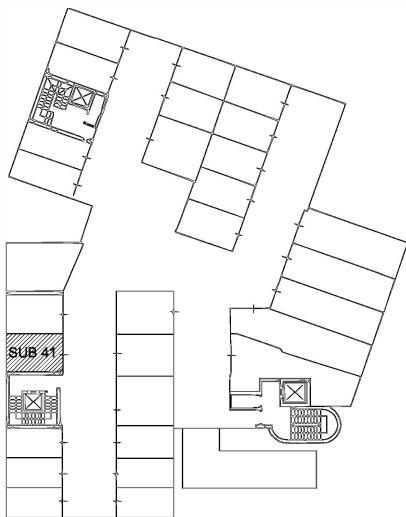

SCHEDA IMMOBILE											
N.	SOPRALLUOGO	DATA	SCALA	PIANO	SUB	CAT	RAPP.	SUP. NETTA	SUP. BALC.	SUP. OMI	SUP. Qmq
36	4	15.03.23	/	INTER.	41	C/6	1:50	16.22 mq	/	19.51 mq	18.66 mq



TRIBUNALE DI SALERNO - 3° SEZIONE CIVILE - E.I. N.
 260/2022 STATO DI FATTO - Proprietà (Omissis)
 Comune di Campagna (SA) - Via Calli - Corpo A - Piano Interrato
 Catasto Fabbricati Foglio 77 part 1055 sub 42

Rampa di accesso

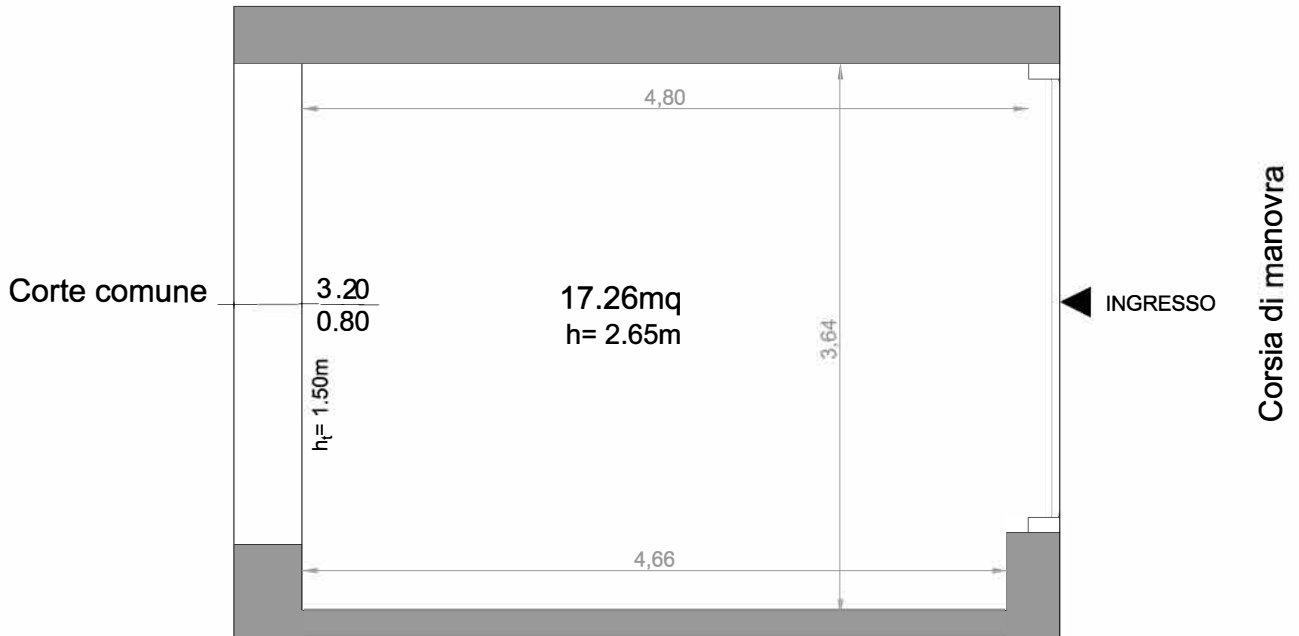

Box auto sub 41

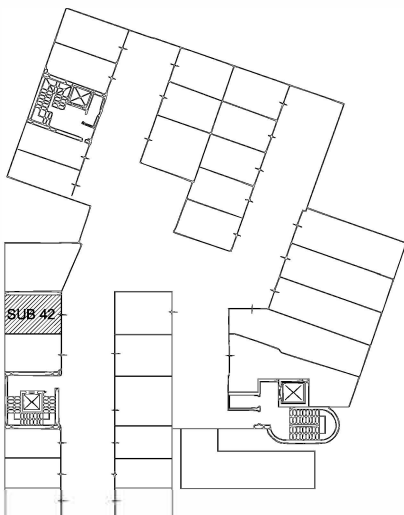

SCHEDA IMMOBILE											
N.	SOPRALLUOGO	DATA	SCALA	PIANO	SUB	CAT	RAPP.	SUP. NETTA	SUP. BALC.	SUP. OMI	SUP. Qmq
37	4	15.03.23	/	INTER.	42	C/6	1:50	17,25 mq	/	20,84 mq	19,97 mq



TRIBUNALE DI SALERNO - 3° SEZIONE CIVILE - E.I. N.
 260/2022 STATO DI FATTO - Proprietà (Omissis)
 Comune di Campagna (SA) - Via Calli - Corpo A - Piano Interrato
 Catasto Fabbricati Foglio 77 part 1055 sub 43

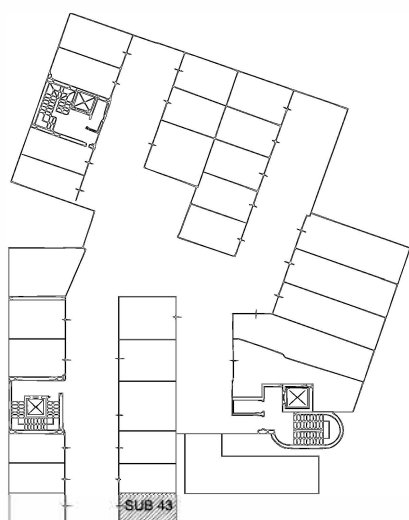
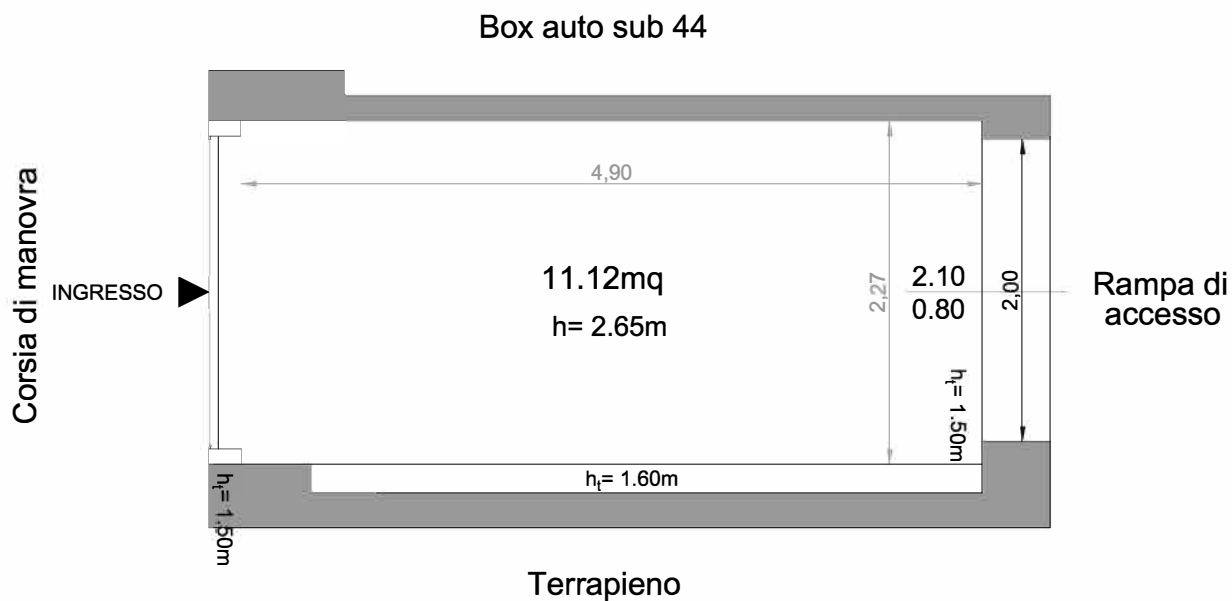

SCHEDA IMMOBILE											
N.	SOPRALLUOGO	DATA	SCALA	PIANO	SUB	CAT	RAPP.	SUP. NETTA	SUP. BALC.	SUP. OMI	SUP. Qmq
38	4	15.03.23	/	INTER.	43	C/6	1:50	11.12 mq	/	14.51 mq	13.91 mq



TRIBUNALE DI SALERNO - 3° SEZIONE CIVILE - E.I. N. 260/2022
 STATO DI FATTO - Proprietà (Omissis)
 - Comune di Campagna (SA) - Via Calli - Corpo A - Piano Interrato
 Catasto Fabbricati - Foglio 77 part 1055 sub 45

Box auto sub 46

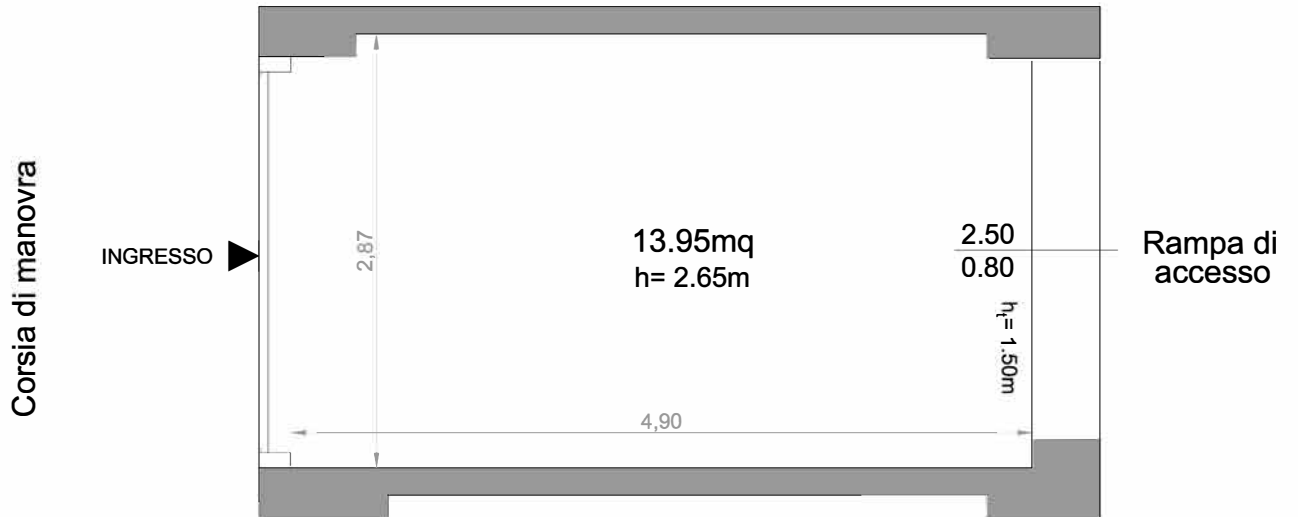

Box auto sub 44

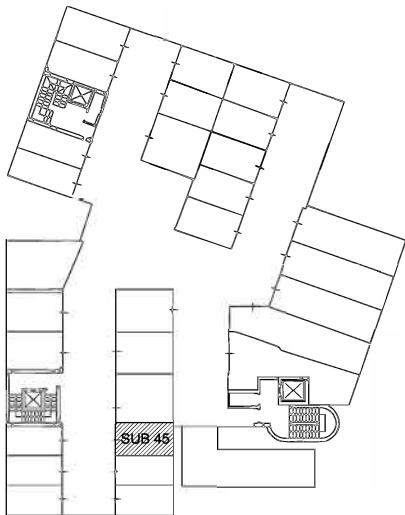

SCHEDA IMMOBILE											
N.	SOPRALLUOGO	DATA	SCALA	PIANO	SUB	CAT	RAPP.	SUP. NETTA	SUP. BALC.	SUP. OMI	SUP. Qmq
39	4	15.03.23	/	INTER.	45	C/6	1:50	13.95 mq	/	16.64 mq	15.95 mq



TRIBUNALE DI SALERNO - 3° SEZIONE CIVILE - E.I. N. 260/2022
 STATO DI FATTO - Proprietà (Omissis)
 - Comune di Campagna (SA) - Via Calli - Corpo A - Piano Interrato
 Catasto Fabbricati Foglio 77 part 1055 sub 46

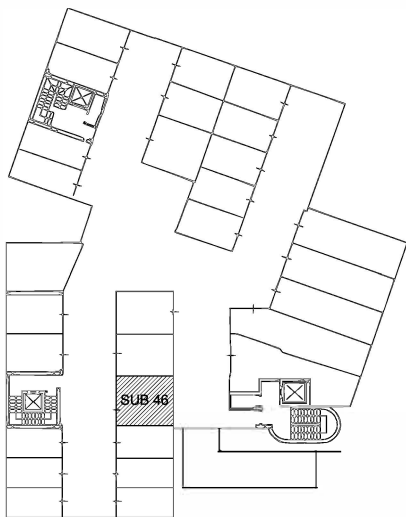
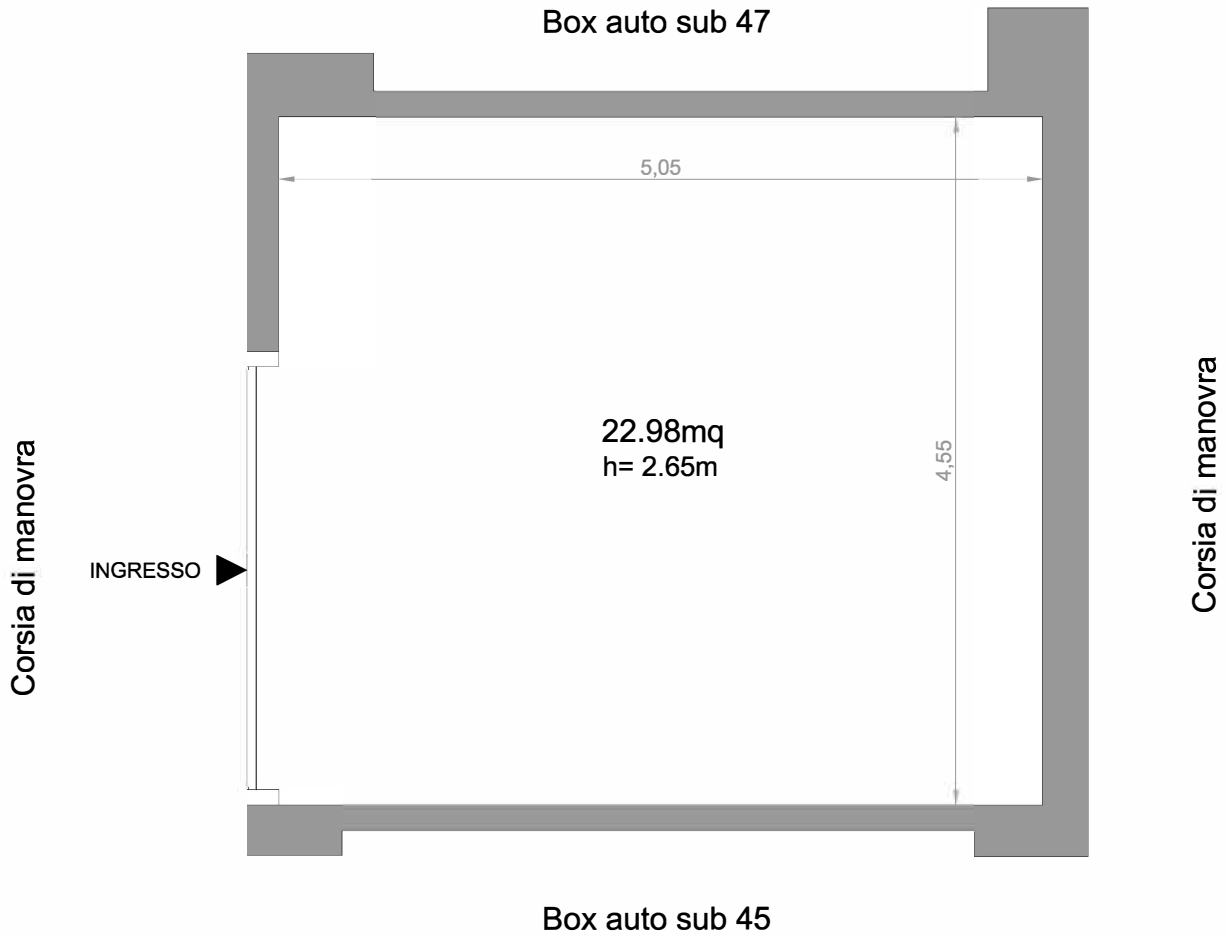

SCHEDA IMMOBILE											
N.	SOPRALLUOGO	DATA	SCALA	PIANO	SUB	CAT	RAPP.	SUP. NETTA	SUP. BALC.	SUP. OMI	SUP. Qmq
40	4	15.03.23	/	INTER.	46	C/6	1:50	22,98 mq	/	25,04 mq	25,04 mq



TRIBUNALE DI SALERNO - 3° SEZIONE CIVILE - E.I. N. 260/2022
 STATO DI FATTO - Proprietà (Omissis)
 - Comune di Campagna (SA) - Via Calli - Corpo A - Piano Interrato
 Catasto Fabbricati Foglio 77 part 1055 sub 47

Box auto sub 48

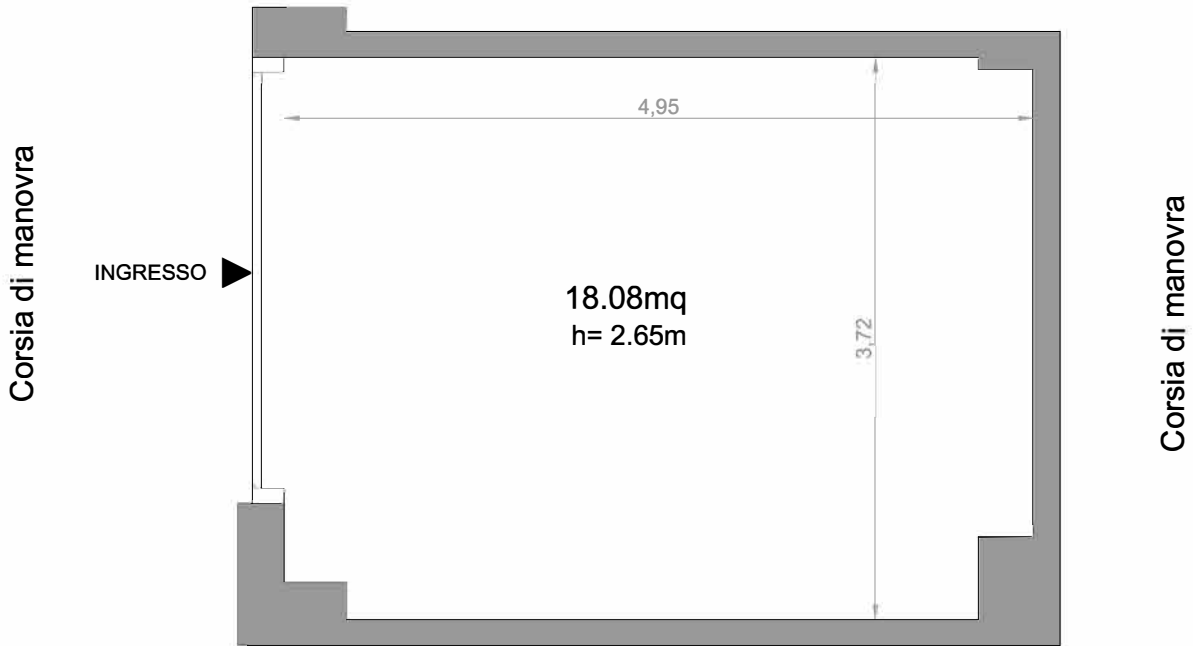

Box auto sub 46

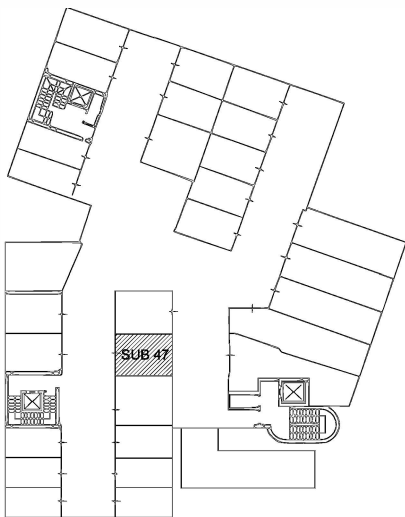

SCHEDA IMMOBILE											
N.	SOPRALLUOGO	DATA	SCALA	PIANO	SUB	CAT	RAPP.	SUP. NETTA	SUP. BALC.	SUP. OMI	SUP. Qmq
41	3	08.03.23	/	INTER.	47	C/6	1:50	18.08 mq	/	20.01 mq	20.01 mq



TRIBUNALE DI SALERNO - 3° SEZIONE CIVILE - E.I. N. 260/2022
 STATO DI FATTO - Proprietà (Omissis)
 - Comune di Campagna (SA) - Via Calli - Corpo A - Piano Interrato
 Catasto Fabbricati Foglio 77 part 1055 sub 48

Corsia di manovra

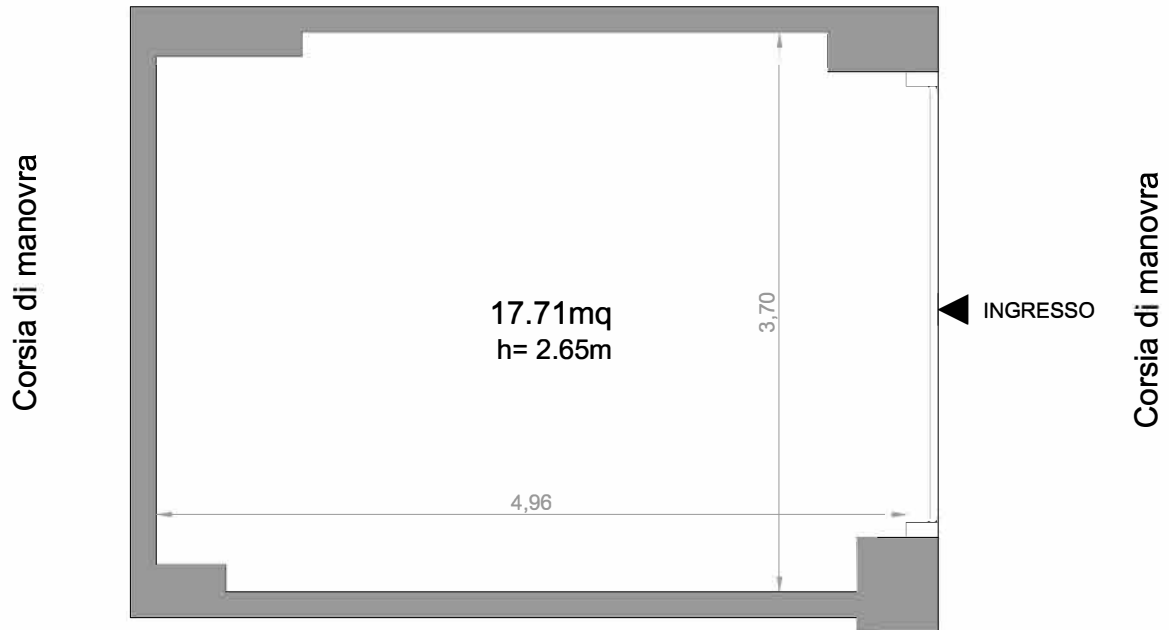

Box auto sub 47

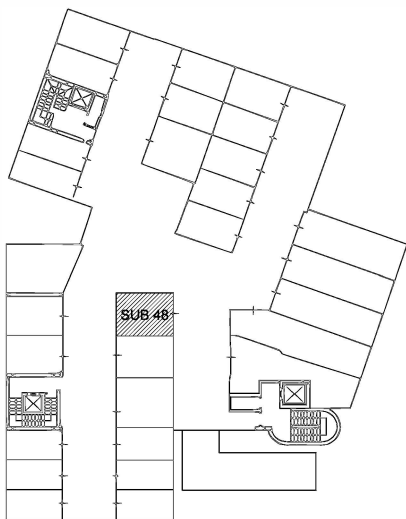

SCHEDA IMMOBILE											
N.	SOPRALLUOGO	DATA	SCALA	PIANO	SUB	CAT	RAPP.	SUP. NETTA	SUP. BALC.	SUP. OMI	SUP. Qmq
42	6	29.03.23	/	INTER.	48	C/6	1:50	17.71 mq	/	19.78 mq	19.78 mq



TRIBUNALE DI SALERNO - 3° SEZIONE CIVILE - E.I. N. 260/2022
 STATO DI FATTO - Proprietà (Omissis)
 Comune di Campagna (SA) - Via Calli - Corpo B - Piano Interrato
 Catasto Fabbricati Foglio 77 part 1055 sub 49

Corsia di manovra

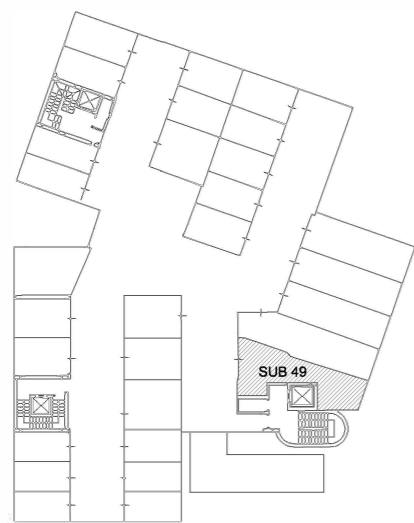
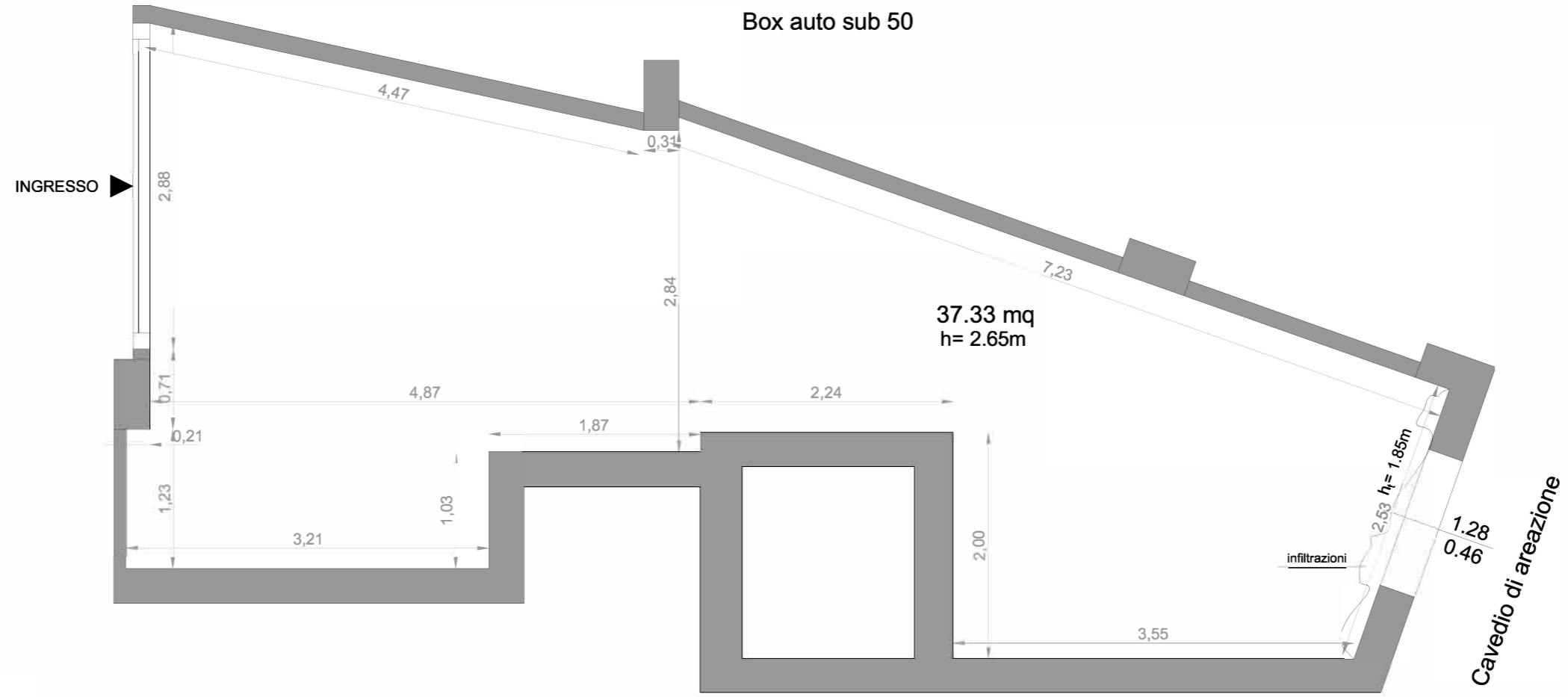

Vano Scale corpo C

SCHEDA IMMOBILE											
N.	SOPRALLUOGO	DATA	SCALA	PIANO	SUB	CAT	RAPP.	SUP. NETTA	SUP. BALC.	SUP. OMI	SUP. Qmq
43	1	22.02.23	/	INTER.	49	C/6	1:50	37.33 mq	/	41.64 mq	41.21 mq



TRIBUNALE DI SALERNO - 3° SEZIONE CIVILE - E.I. N. 260/2022
 STATO DI FATTO - Proprietà (Omissis)
 Comune di Campagna (SA) - Via Calli - Corpo B - Piano Interrato
 Catasto Fabbricati Foglio 77 part 1055 sub 50

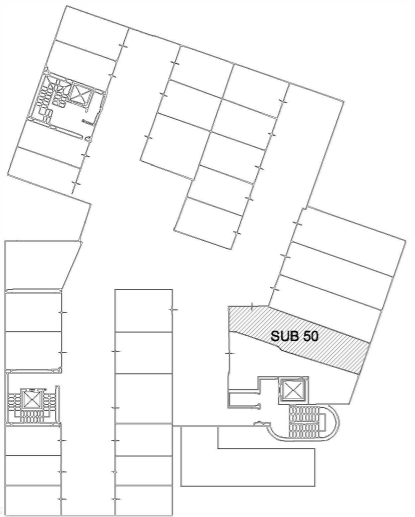
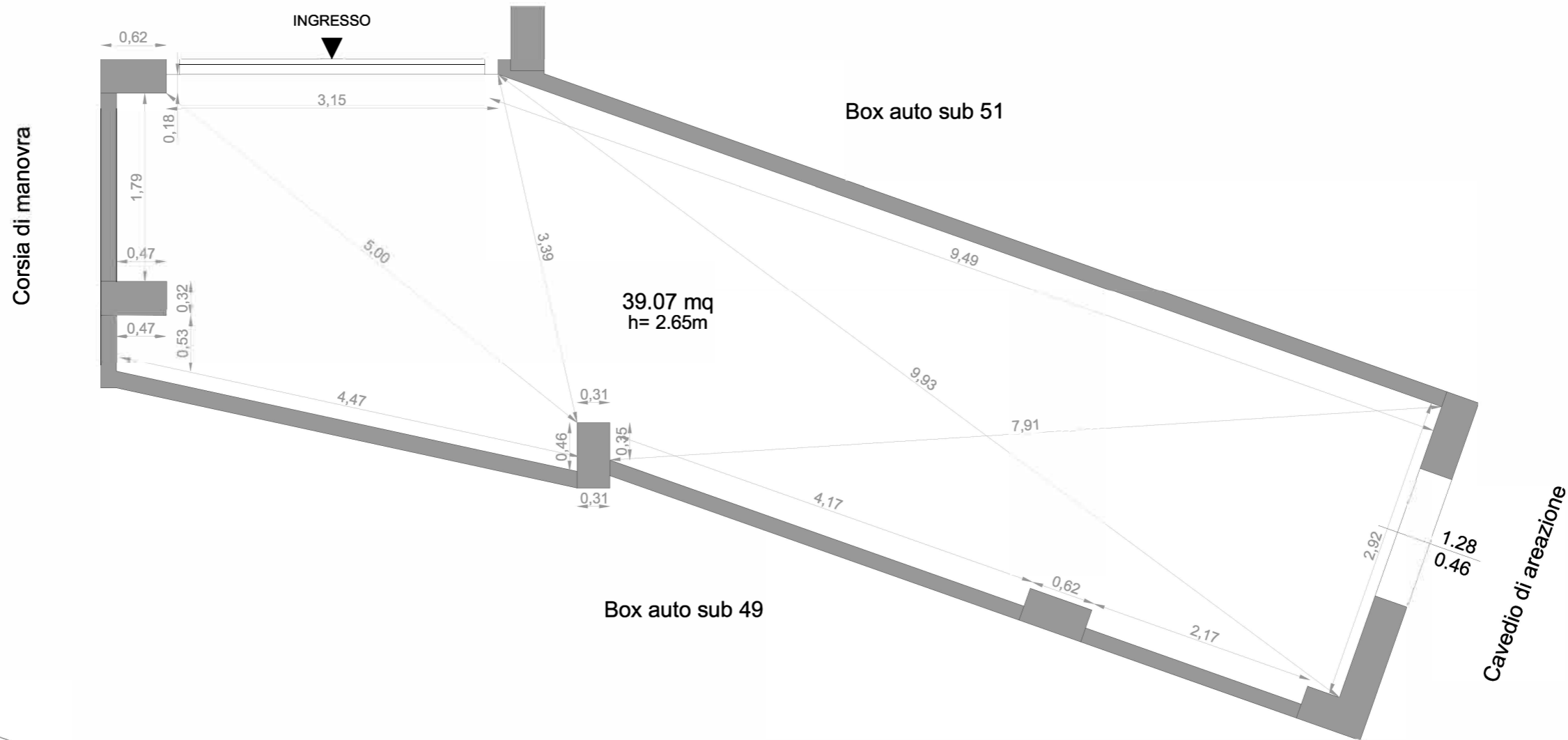

SCHEDA IMMOBILE											
N.	SOPRALLUOGO	DATA	SCALA	PIANO	SUB	CAT	RAPP.	SUP. NETTA	SUP. BALC.	SUP. OMI	SUP. Qmq
44	1	22.02.23	/	INTER.	50	C/6	1:50	39.07 mq	/	42.63 mq	42.11 mq



TRIBUNALE DI SALERNO - 3° SEZIONE CIVILE - E.I. N. 260/2022
 STATO DI FATTO - Proprietà (Omissis)
 - Comune di Campagna (SA) - Via Calli - Corpo B - Piano Interrato
 Catasto Fabbricati Foglio 77 part 1055 sub 51

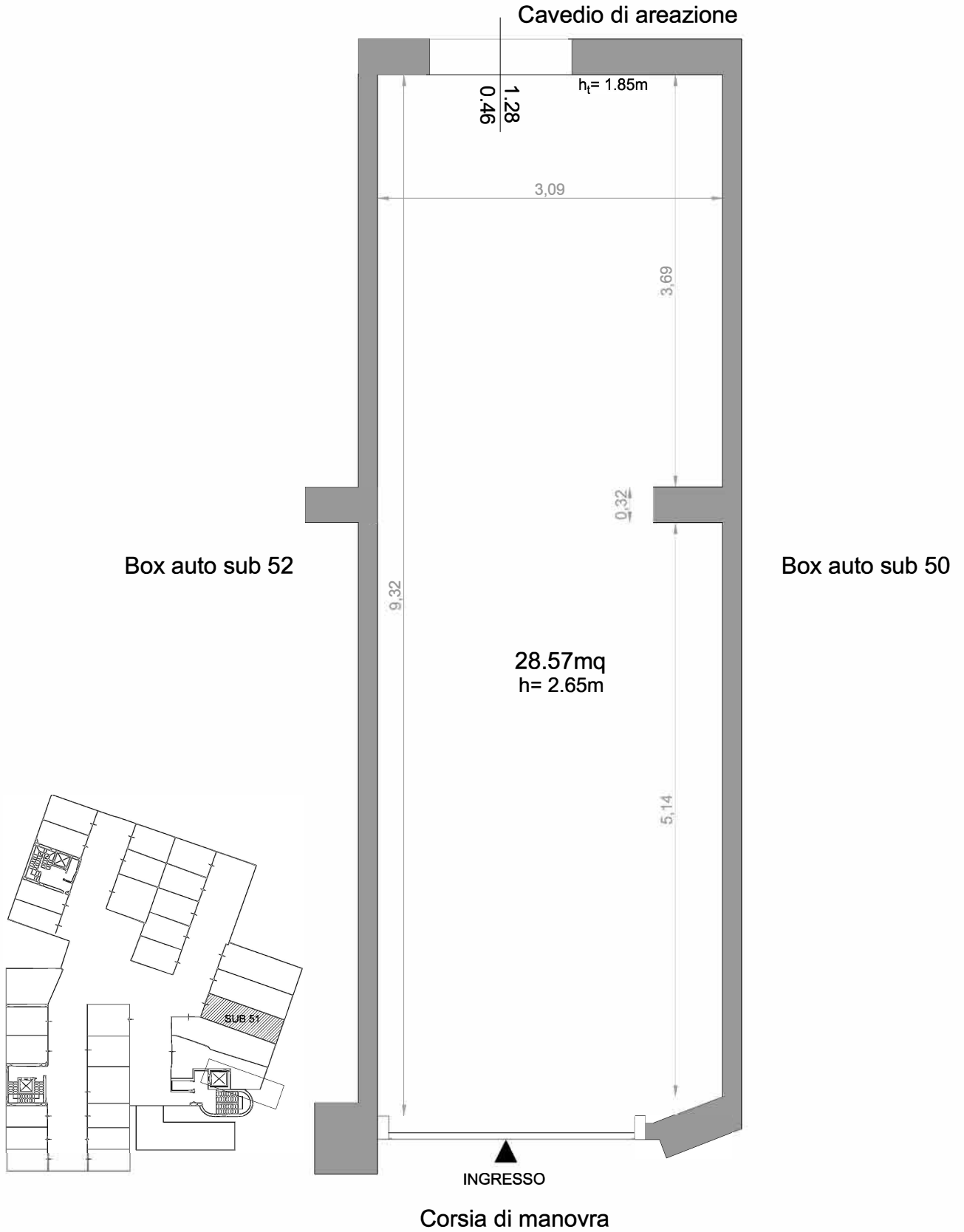

SCHEDA IMMOBILE											
N.	SOPRALLUOGO	DATA	SCALA	PIANO	SUB	CAT	RAPP.	SUP. NETTA	SUP. BALC.	SUP. OMI	SUP. Qmq
45	6	29.03.23	/	INTER.	51	C/6	1:50	28.57 mq	/	31.75 mq	31.22 mq



TRIBUNALE DI SALERNO - 3° SEZIONE CIVILE - E.I. N. 260/2022
 STATO DI FATTO - Proprietà (Omissis)
 Comune di Campagna (SA) - Via Calli - Corpo B - Piano Interrato
 Catasto Fabbricati Foglio 77 part 1055 sub 52

Cavedio di areazione

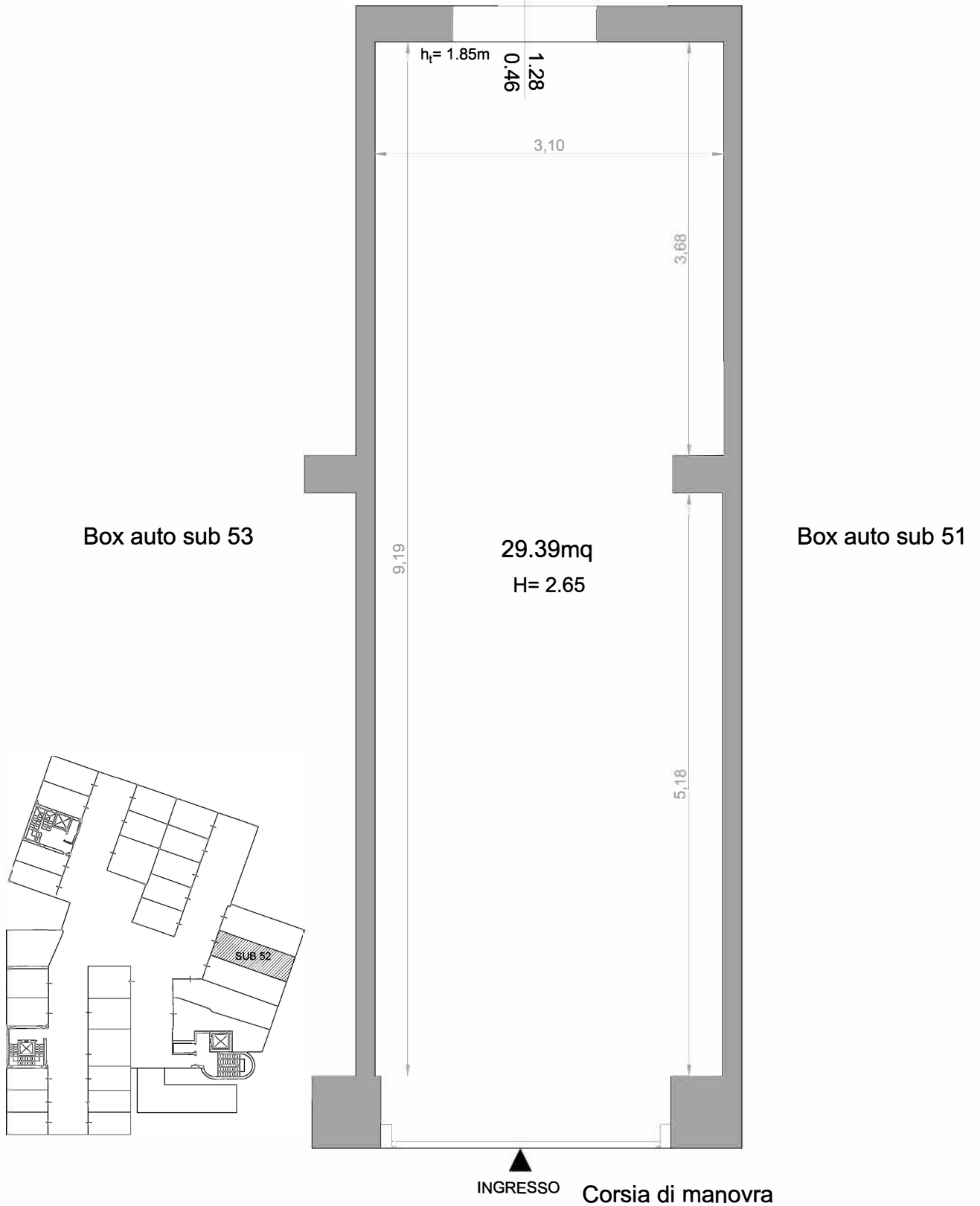

SCHEDA IMMOBILE											
N.	SOPRALLUOGO	DATA	SCALA	PIANO	SUB	CAT	RAPP.	SUP. NETTA	SUP. BALC.	SUP. OMI	SUP. Qmq
46	9	26.04.23	/	INTER.	52	C/6	1:50	29.39mq	/	32.79 mq	32.27 mq

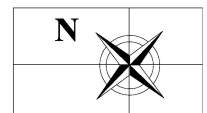

TRIBUNALE DI SALERNO - 3° SEZIONE CIVILE - E.I. N. 260/2022
 STATO DI FATTO - Proprietà (Omissis)
 - Comune di Campagna (SA) - Via Calli - Corpo B - Piano Interrato
 Catasto Fabbricati Foglio 77 part 1055 sub 53

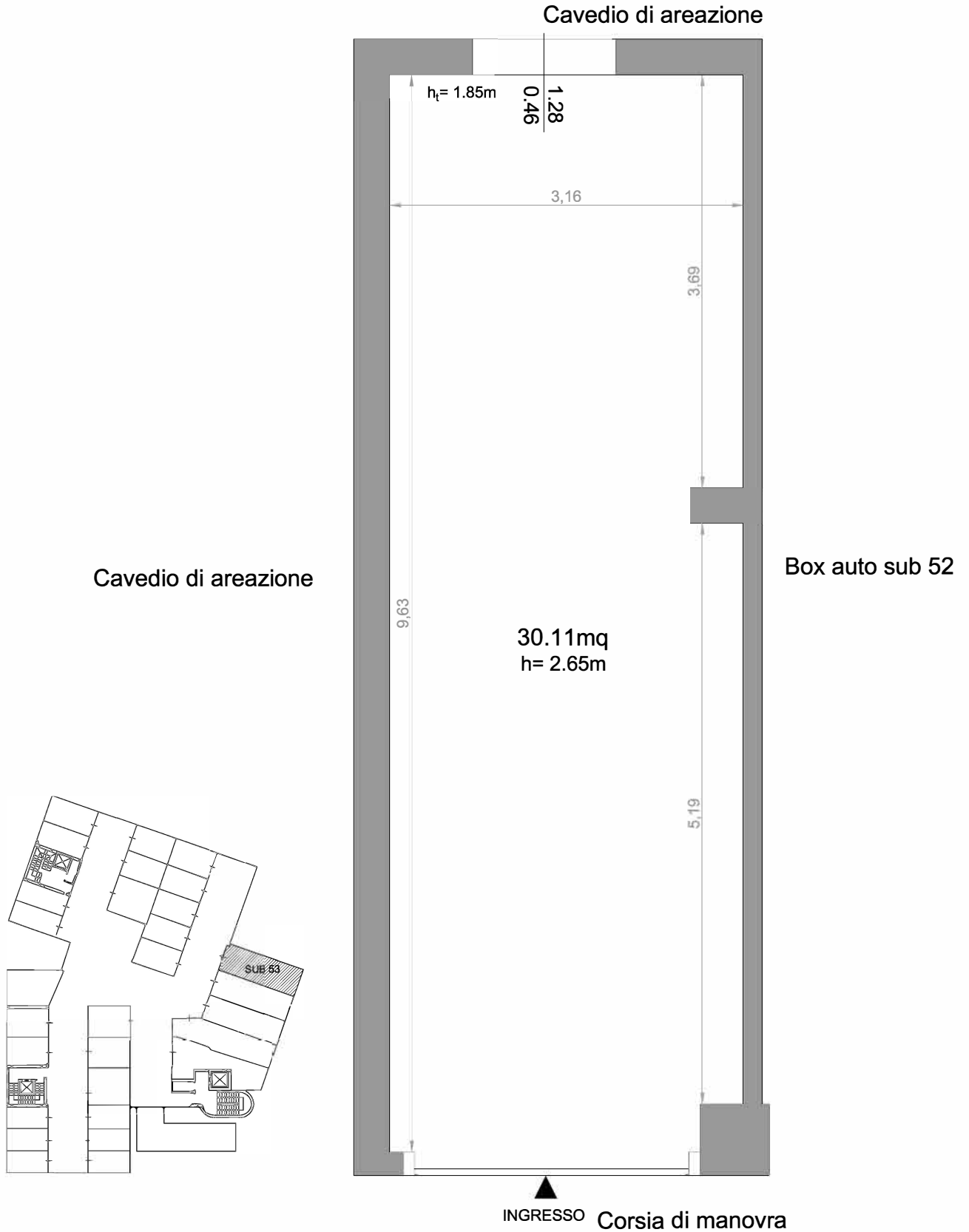

SCHEDA IMMOBILE											
N.	SOPRALLUOGO	DATA	SCALA	PIANO	SUB	CAT	RAPP.	SUP. NETTA	SUP. BALC.	SUP. OMI	SUP. Qmq
47	6	29.03.23	/	INTER.	53	C/6	1:50	30.11 mq	/	35.85 mq	35.27 mq



TRIBUNALE DI SALERNO - 3° SEZIONE CIVILE - E.I. N. 260/2022
 STATO DI FATTO - Proprietà (Omissis)
 - Comune di Campagna (SA) - Via Calli - Corpo B - Piano Interrato
 Catasto Fabbricati Foglio 77 part 1055 sub 54

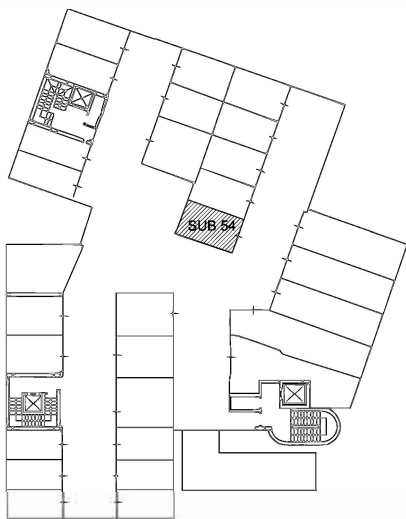

SCHEDA IMMOBILE											
N.	SOPRALLUOGO	DATA	SCALA	PIANO	SUB	CAT	RAPP.	SUP. NETTA	SUP. BALC.	SUP. OMI	SUP. Qmq
48	8	12.04.23	/	INTER.	54	C/6	1:50	16.40 mq	/	18.07 mq	18.07 mq



TRIBUNALE DI SALERNO - 3° SEZIONE CIVILE - E.I. N.
 260/2022 STATO DI FATTO - Proprietà (Omissis)
 Comune di Campagna (SA) - Via Calli - Corpo B - Piano Interrato
 Catasto Fabbricati Foglio 77 part 1055 sub 55

Box auto sub 56

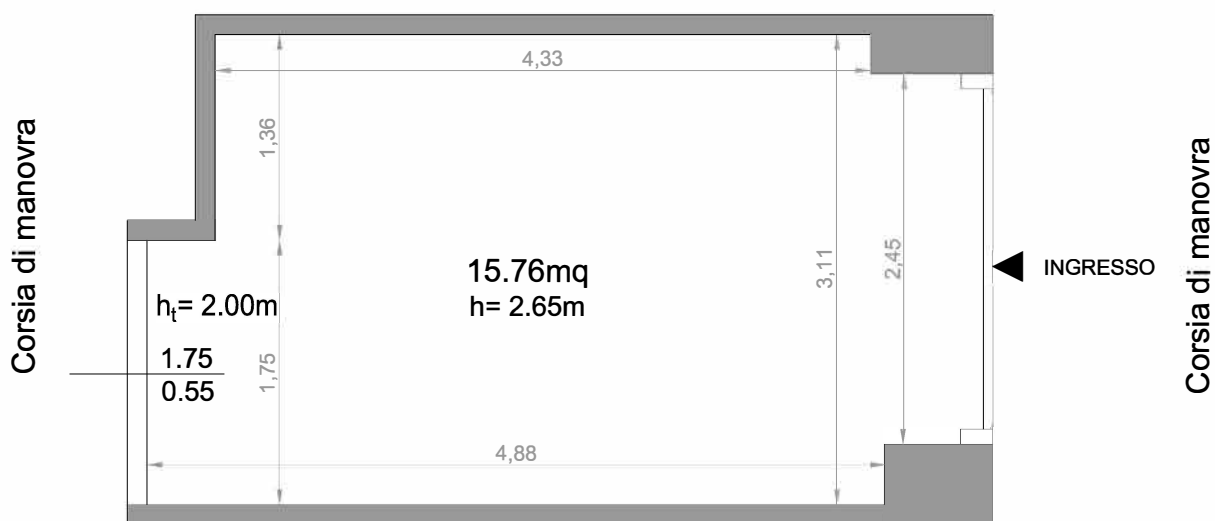

Box auto sub 54

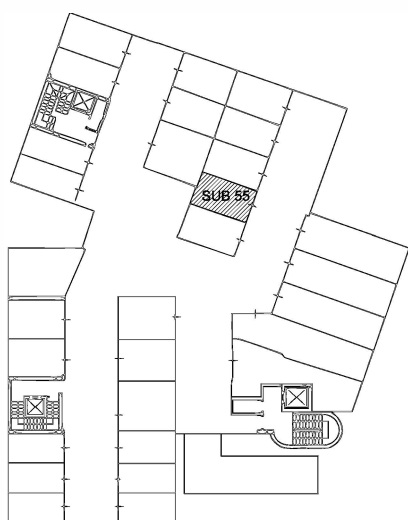

SCHEDA IMMOBILE											
N.	SOPRALLUOGO	DATA	SCALA	PIANO	SUB	CAT	RAPP.	SUP. NETTA	SUP. BALC.	SUP. OMI	SUP. Qmq
49	2	01.03.23	/	INTER.	55	C/6	1:50	15.76 mq	/	17.37 mq	17.37 mq



TRIBUNALE DI SALERNO - 3° SEZIONE CIVILE - E.I. N. 260/2022
 STATO DI FATTO - Proprietà (Omissis)
 Comune di Campagna (SA) - Via Calli - Corpo B - Piano Interrato
 Catasto Fabbricati Foglio 77 part 1055 sub 56

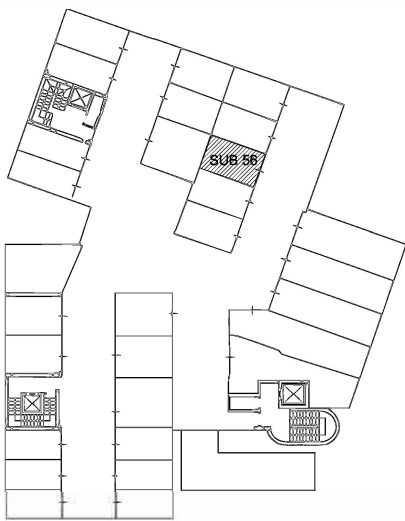
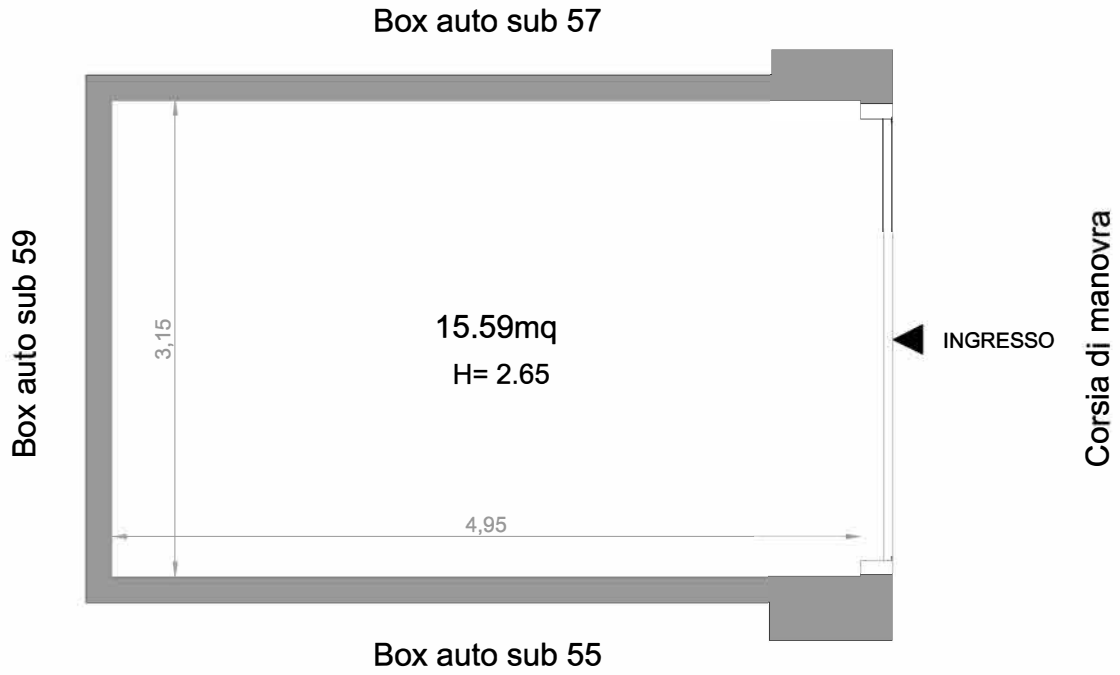

SCHEDA IMMOBILE											
N.	SOPRALLUOGO	DATA	SCALA	PIANO	SUB	CAT	RAPP.	SUP. NETTA	SUP. BALC.	SUP. OMI	SUP. Qmq
50	9	26.04.23	/	INTER.	56	C/6	1:50	15.59 mq	/	17.06 mq	17.06 mq



TRIBUNALE DI SALERNO - 3° SEZIONE CIVILE - E.I. N.
 260/2022 STATO DI FATTO - Proprietà (Omissis)
 Comune di Campagna (SA) - Via Calli - Corpo B - Piano Interrato
 Catasto Fabbricati Foglio 77 part 1055 sub 57

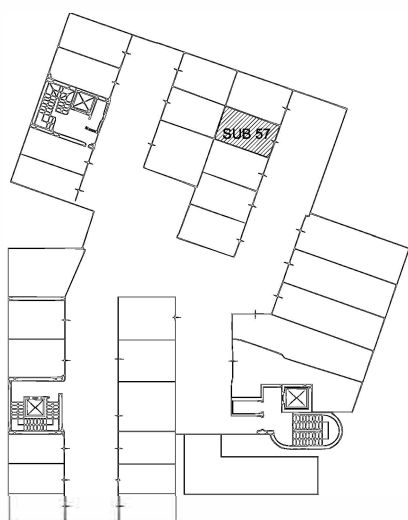
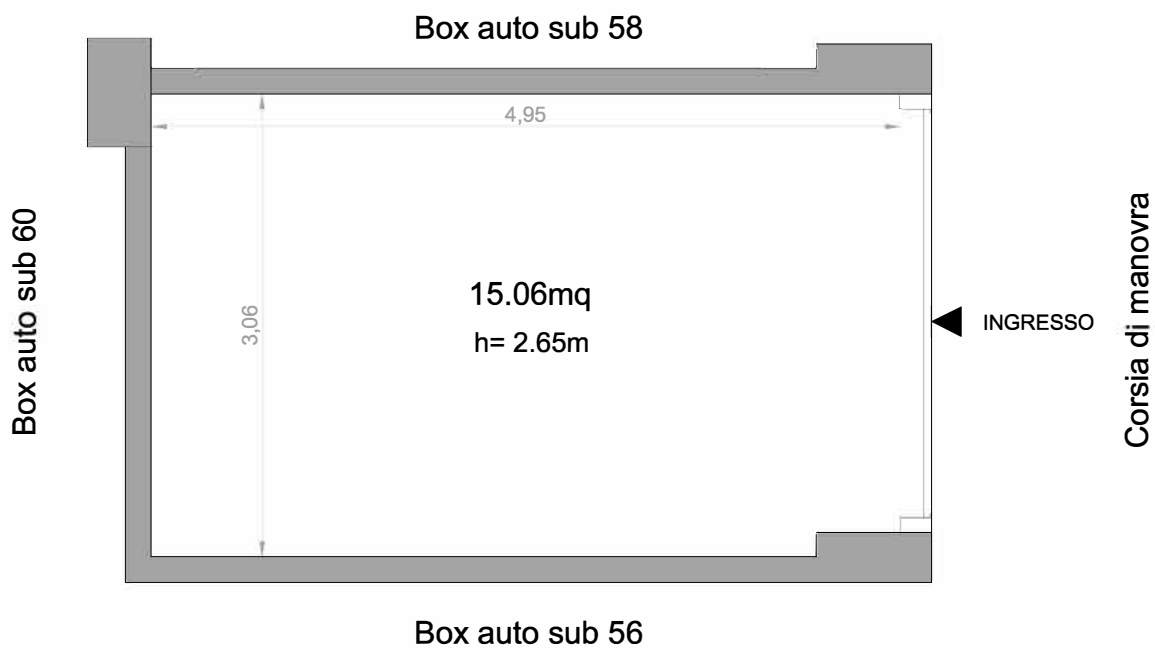

SCHEDA IMMOBILE											
N.	SOPRALLUOGO	DATA	SCALA	PIANO	SUB	CAT	RAPP.	SUP. NETTA	SUP. BALC.	SUP. OMI	SUP. Qmq
51	5	22.03.23	/	INTER.	57	C/6	1:50	15.06 mq	/	16.60 mq	16.60 mq



TRIBUNALE DI SALERNO - 3° SEZIONE CIVILE - E.I. N. 260/2022
 STATO DI FATTO - Proprietà (Omissis)
 Comune di Campagna (SA) - Via Calli - Corpo B - Piano Interrato
 Catasto Fabbricati Foglio 77 part 1055 sub 58

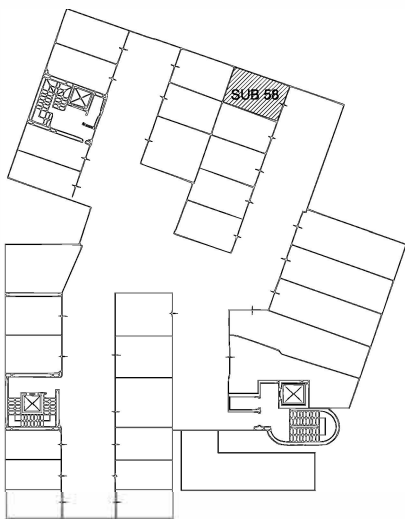
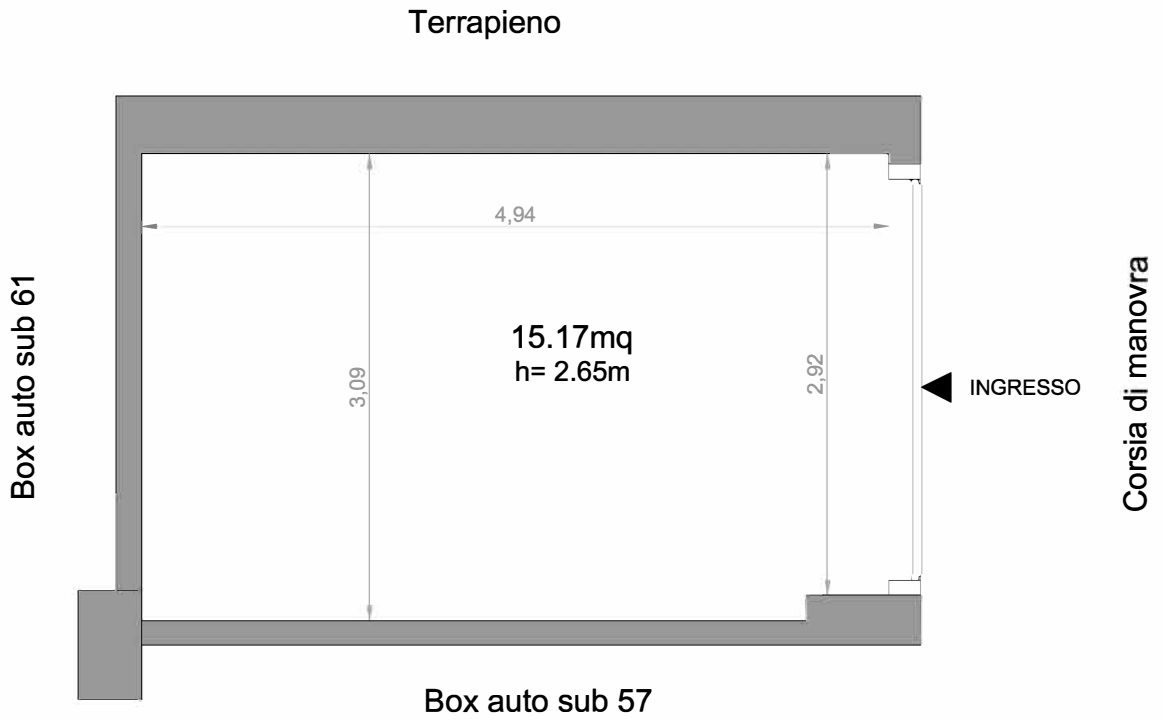

SCHEDA IMMOBILE											
N.	SOPRALLUOGO	DATA	SCALA	PIANO	SUB	CAT	RAPP.	SUP. NETTA	SUP. BALC.	SUP. OMI	SUP. Qmq
52	6	29.03.23	/	INTER.	58	C/6	1:50	15.17 mq	/	18.21 mq	17.24 mq



TRIBUNALE DI SALERNO - 3° SEZIONE CIVILE - E.I. N. 260/2022
 STATO DI FATTO - Proprietà (Omissis)
 Comune di Campagna (SA) - Via Calli - Corpo B - Piano Interrato
 Catasto Fabbricati Foglio 77 part 1055 sub 59

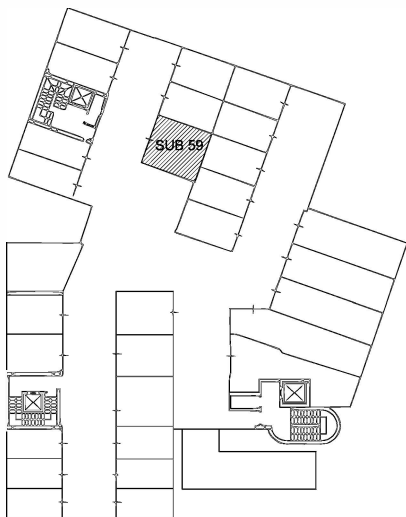
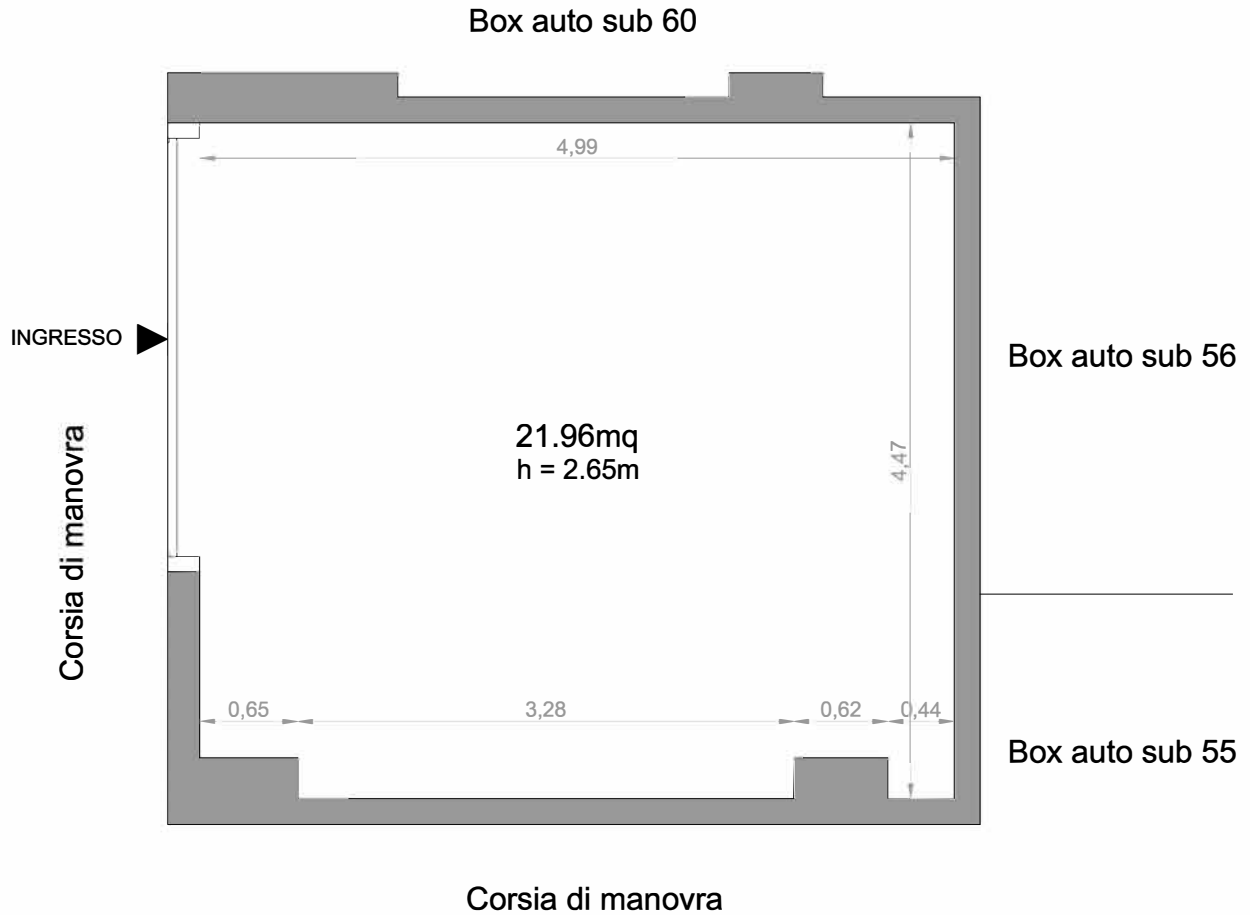

SCHEDA IMMOBILE												
N.	SOPRALLUOGO	DATA	SCALA	PIANO	SUB	CAT	POSSESSO	RAPP.	SUP. NETTA	SUP. BALC.	SUP. OMI	SUP. Qmq
53	9	26.04.23	/	INTER.	59	C/6	BARBETTA	1:50	21.96 mq	/	24.04 mq	24.04 mq



TRIBUNALE DI SALERNO - 3° SEZIONE CIVILE - E.I. N. 260/2022
 STATO DI FATTO - Proprietà (Omissis)
 Comune di Campagna (SA) - Via Calli - Corpo C - Piano Interrato
 Catasto Fabbricati Foglio 77 part 1055 sub 60

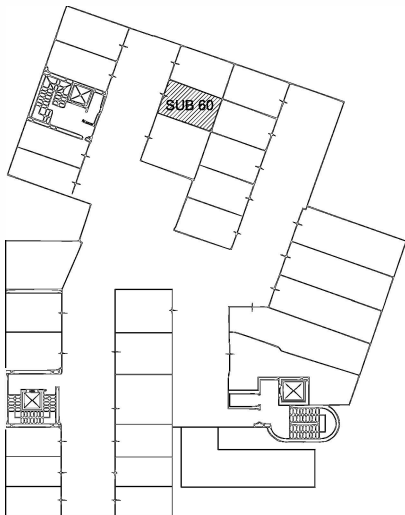
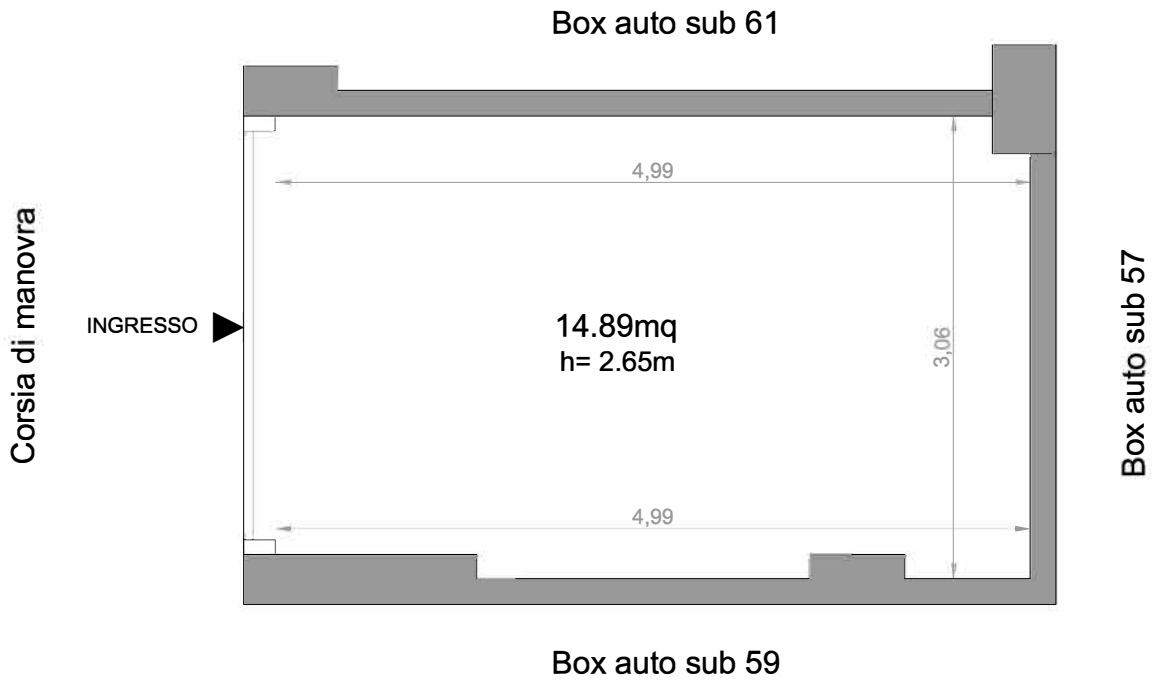

SCHEDA IMMOBILE												
N.	SOPRALLUOGO	DATA	SCALA	PIANO	SUB	CAT	POSSESSO	RAPP.	SUP. NETTA	SUP. BALC.	SUP. OMI	SUP. Qmq
54	8	12.04.23	/	INTER.	60	C/6	SANTOSUOSSO	1:50	14.89 mq	/	16.75 mq	16.75 mq



TRIBUNALE DI SALERNO - 3° SEZIONE CIVILE - E.I. N. 260/2022
 STATO DI FATTO - Proprietà (Omissis)
 Comune di Campagna (SA) - Via Calli - Corpo B - Piano Interrato
 Catasto Fabbricati Foglio 77 part 1055 sub 61

Terrapieno

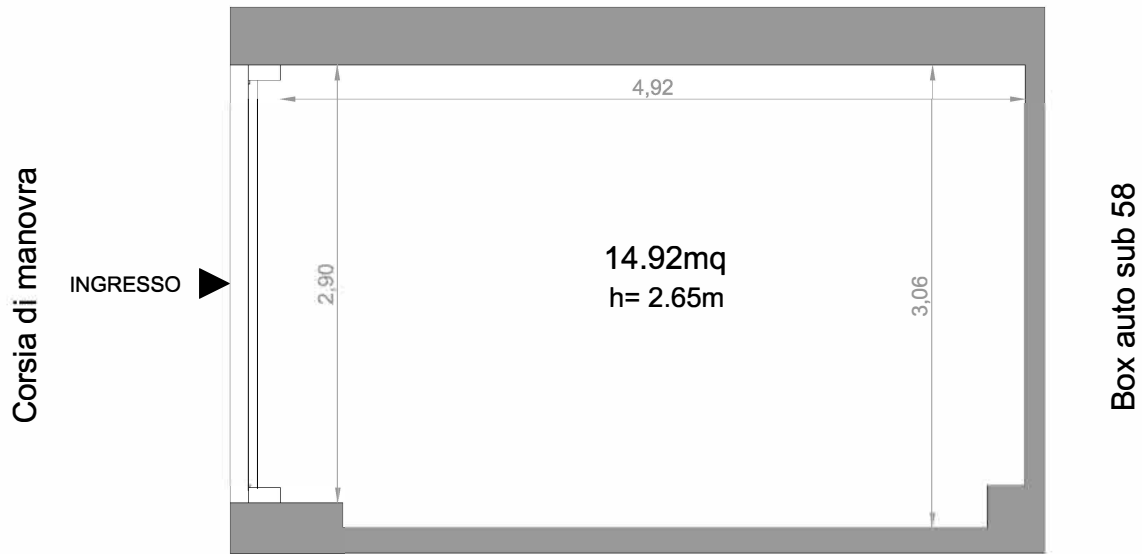

Box auto sub 60

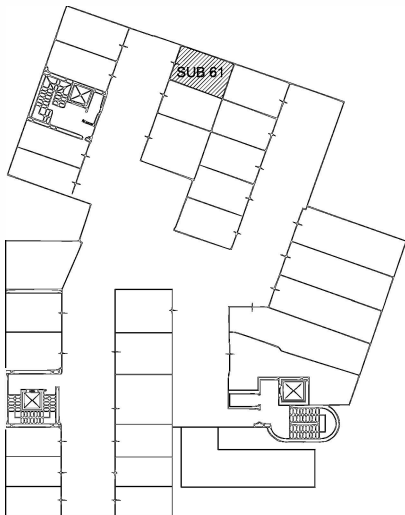

SCHEDA IMMOBILE												
N.	SOPRALLUOGO	DATA	SCALA	PIANO	SUB	CAT	POSSESSO	RAPP.	SUP. NETTA	SUP. BALC.	SUP. OMI	SUP. Qmq
55	2	01.03.23	/	INTER.	61	C/6	PESCE	1:50	14,92 mq	/	18,15 mq	17,25 mq



TRIBUNALE DI SALERNO - 3° SEZIONE CIVILE - E.I. N.
 260/2022 STATO DI FATTO - Proprietà (Omissis)
 Comune di Campagna (SA) - Via Calli - Corpo B - Piano Interrato
 Catadsto Fabbricati Foglio 77 part 1055 sub 62

Box auto sub 63

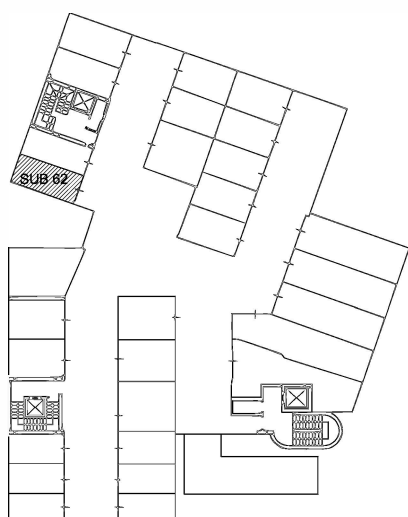
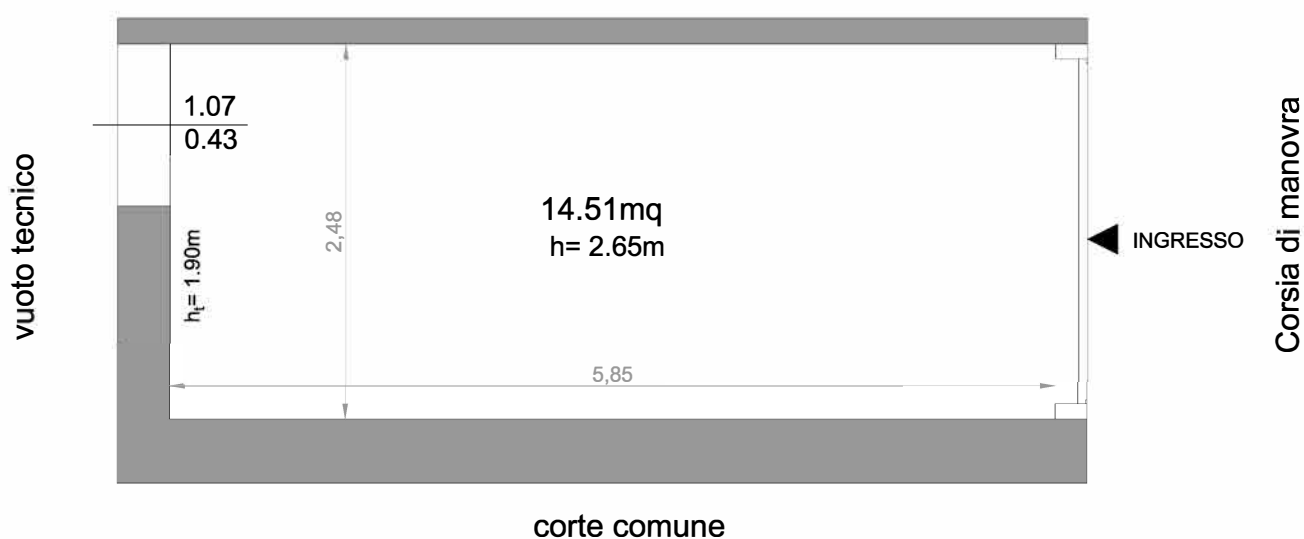

SCHEDA IMMOBILE												
N.	SOPRALLUOGO	DATA	SCALA	PIANO	SUB	CAT	INTESTATARIO	RAPP.	SUP. NETTA	SUP. BALC.	SUP. OMI	SUP. Qmq
56	9	26.04.23	/	INTER.	62	C/6	VISCOVO	1:50	14.51 mq	/	18.82 mq	17.00 mq



TRIBUNALE DI SALERNO - 3° SEZIONE CIVILE - E.I. N.
 260/2022 STATO DI FATTO - Proprietà (Omissis)
 Comune di Campagna (SA) - Via Calli - Corpo B - Piano Interrato
 Catasto Fabbricati Foglio 77 part 1055 sub 64

Box auto sub 65



vano scale corpo C

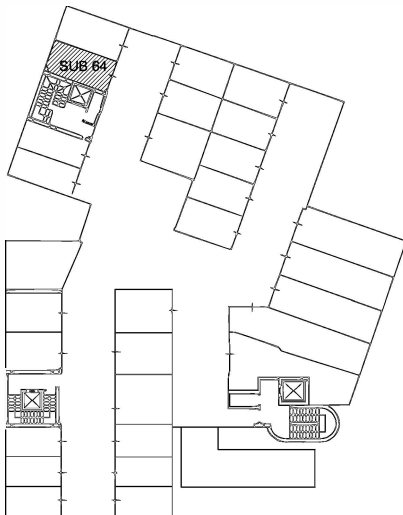

SCHEDA IMMOBILE												
N.	SOPRALLUOGO	DATA	SCALA	PIANO	SUB	CAT	POSSESSO	RAPP.	SUP. NETTA	SUP. BALC.	SUP. OMI	SUP. Qmq
57	7	05.04.23	/	INTER.	64	C/6	DI BENEDETTO	1:50	16.59 mq	/	19.13 mq	18.62 mq

N
