

ALLEGATO 1

Elaborati grafici

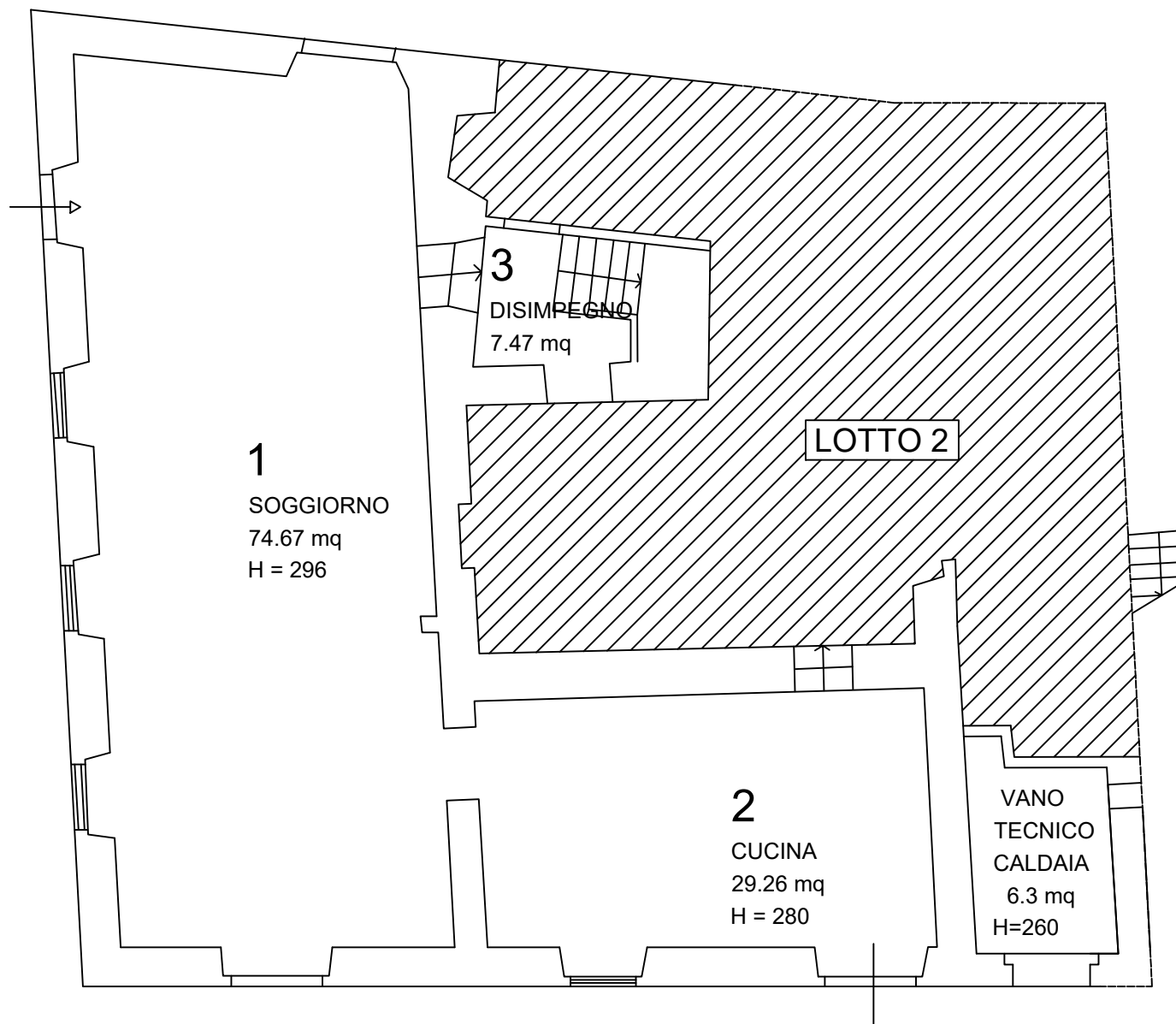



LOTTO 1

Tavola 1

Piano terra

Pianta appartamento in casa ex colonica

Scala 1:100

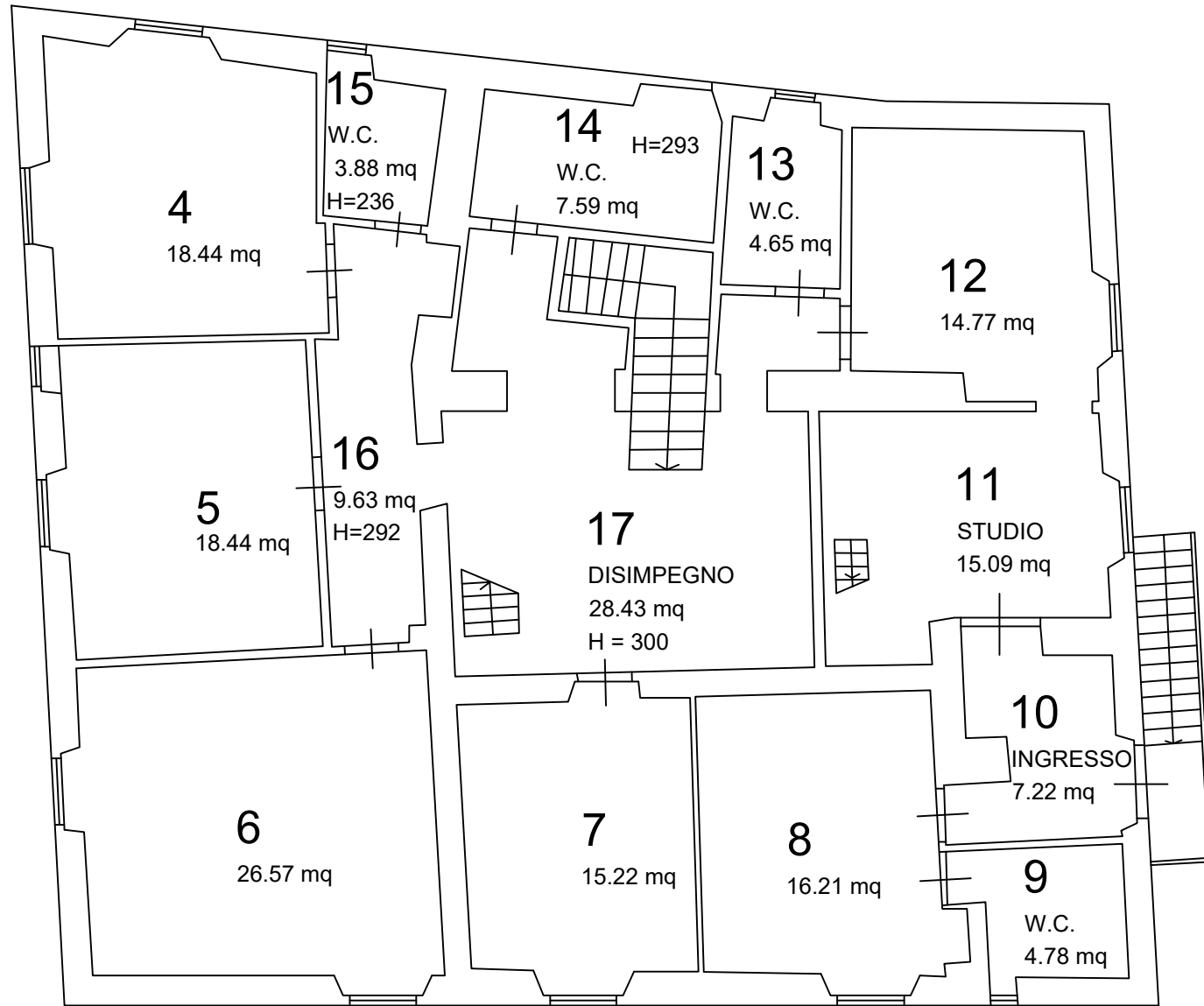

LOTTO 1
 Tavola 2
 Piano primo
 Pianta appartamento in casa ex-colonica
 Scala 1:100

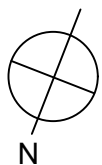
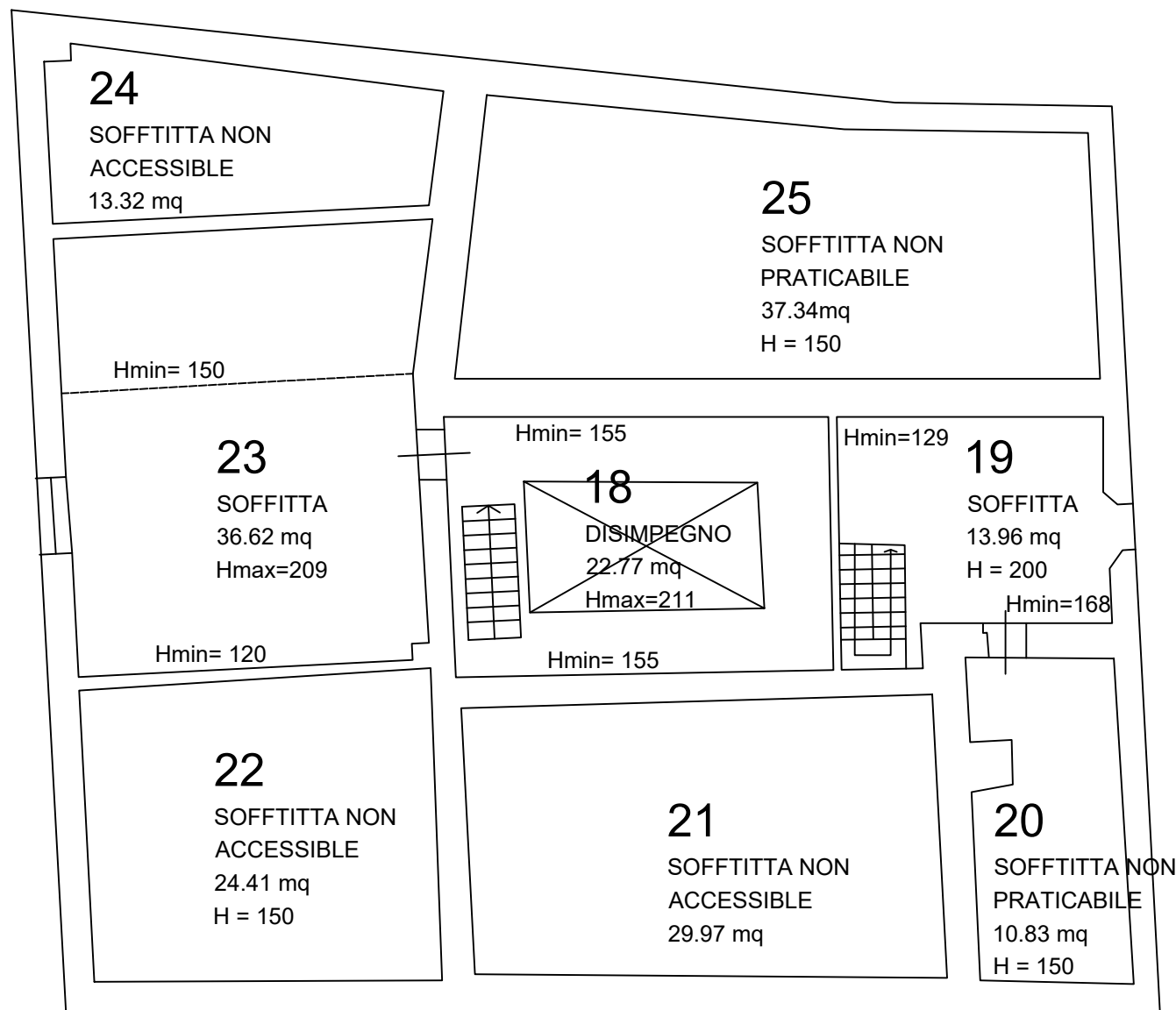

LOTTO 1
Tavola 3
Piano secondo
Pianta appartamento in casa ex-colonica
Scala 1:100

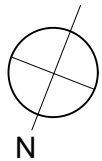
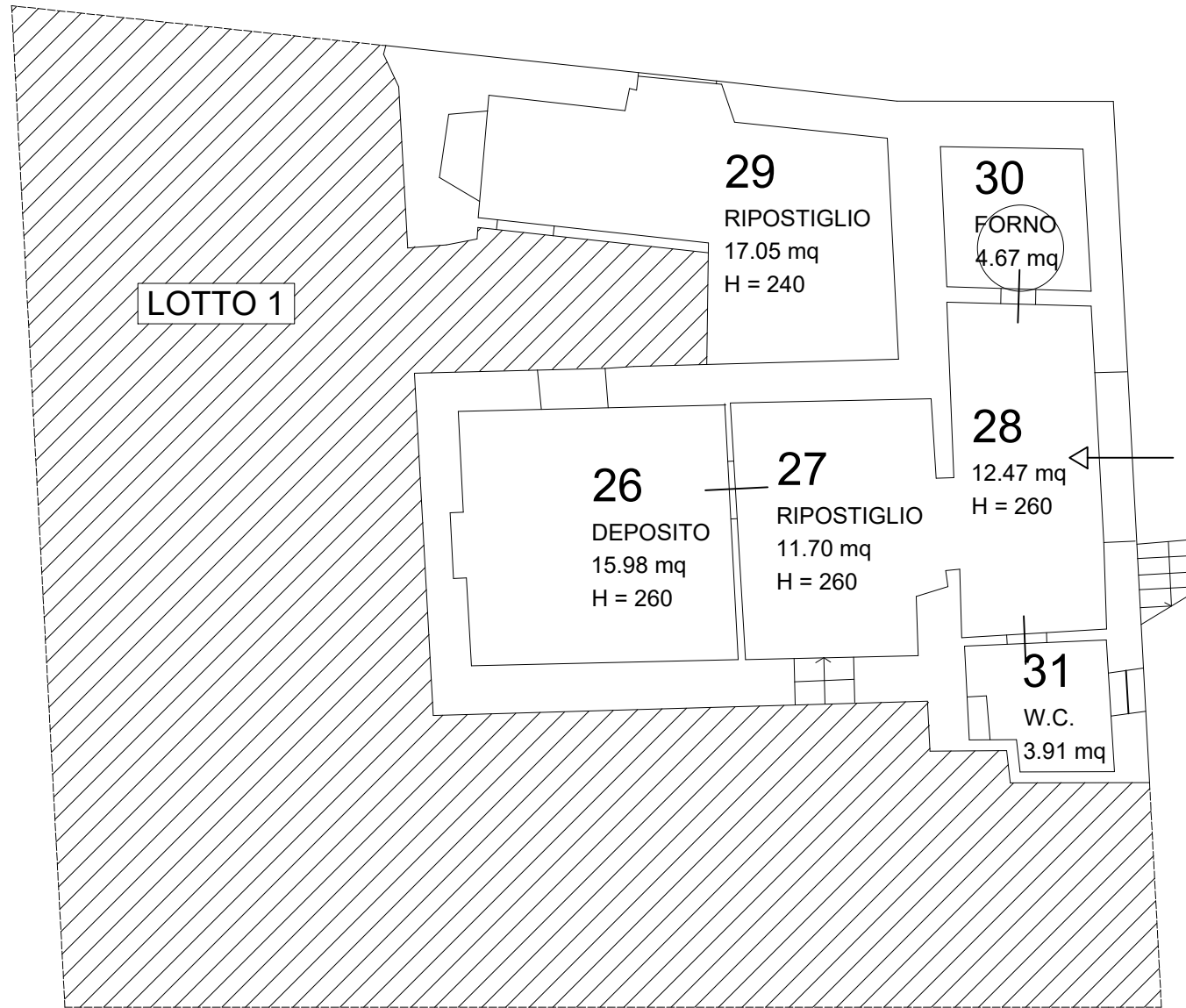

LOTTO 2
 Tavola 1
 Piano terra
 Porzione di casa ex-colonica ad uso agricolo
 Scala 1:100

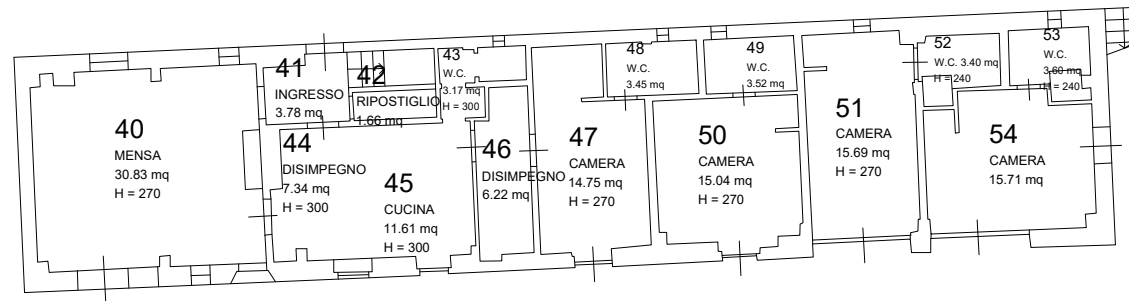

PIANO TERRA
Pianta fabbricato accoglienza agrituristica

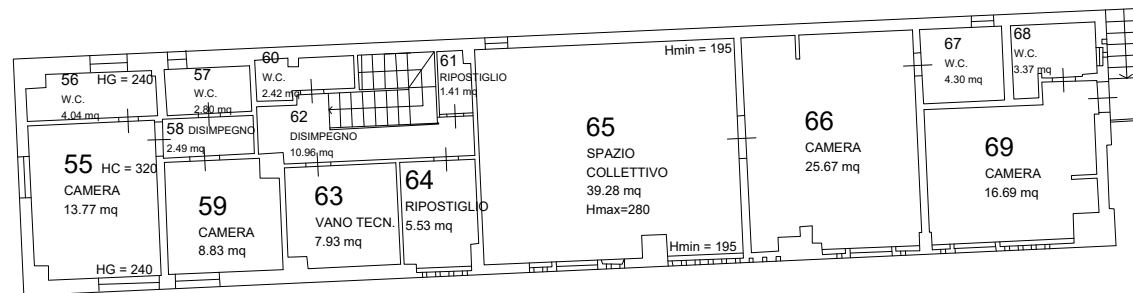

PIANO PRIMO
Pianta fabbricato accoglienza agrituristica

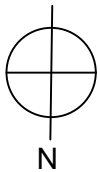

LOTTO 2
Tavola 2
Piano terra e piano primo
Pianta fabbricato accoglienza agrituristica
Scala 1:200

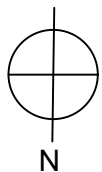
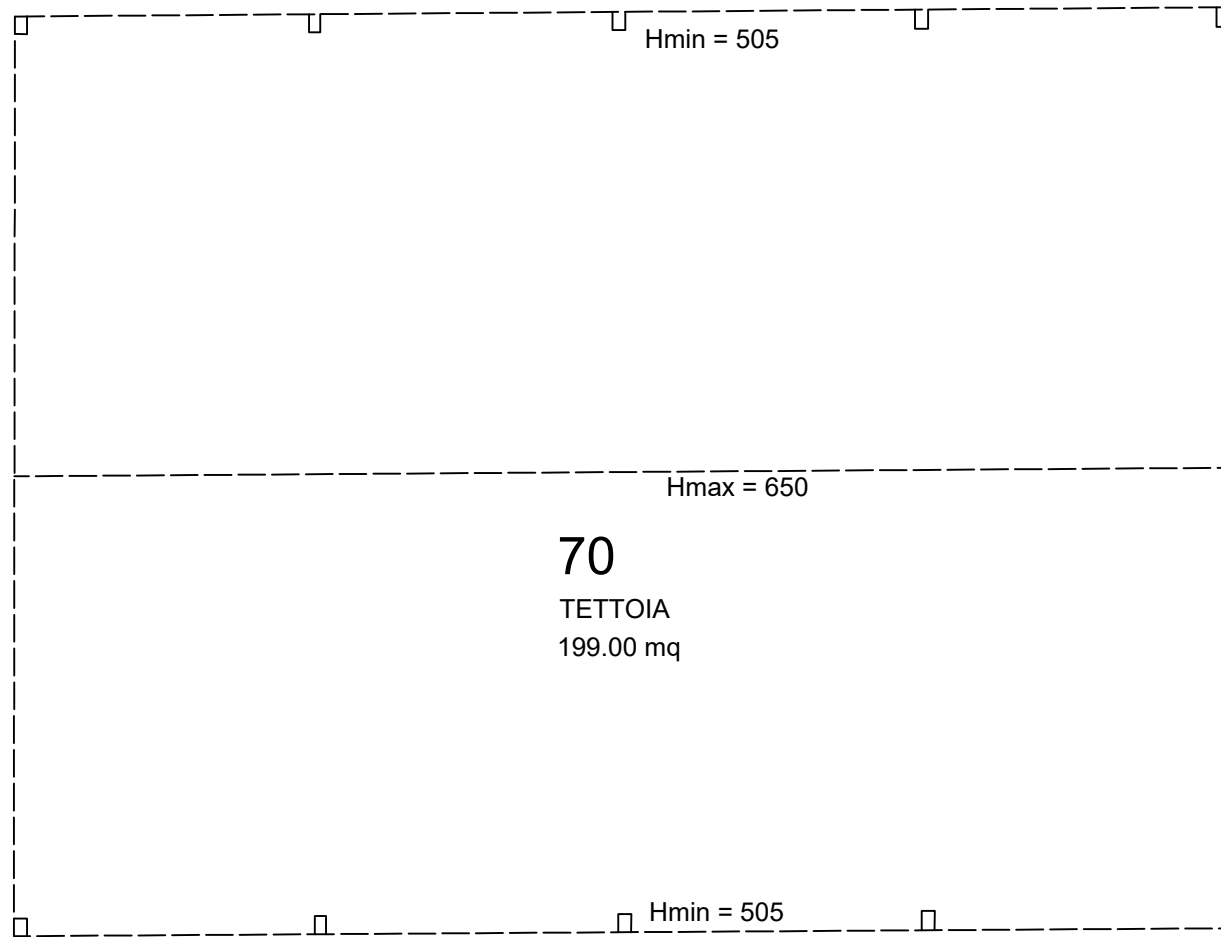

LOTTO 2
Tavola 3
Piano terra
Pianta tettoia
Scala 1:100

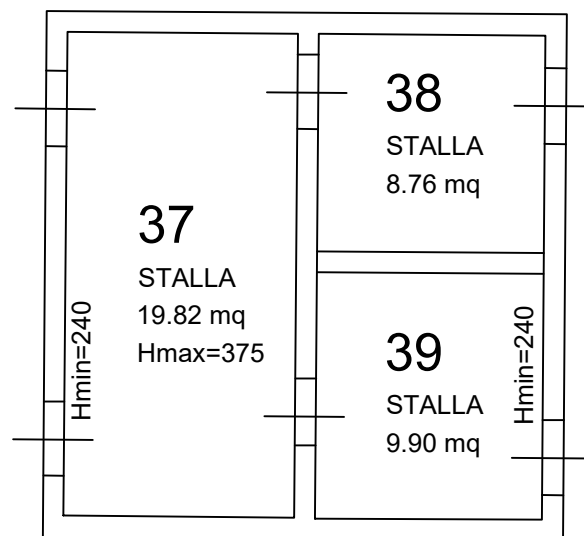

PIANO TERRA Stalla

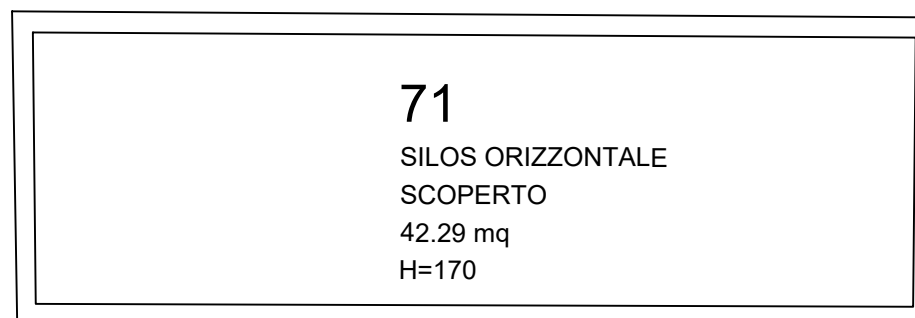

PIANO TERRA Silos scoperto

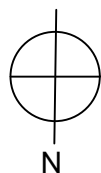

LOTTO 2
Tavola 4
Piano terra
Pianta silos e tettoia
Scala 1:100

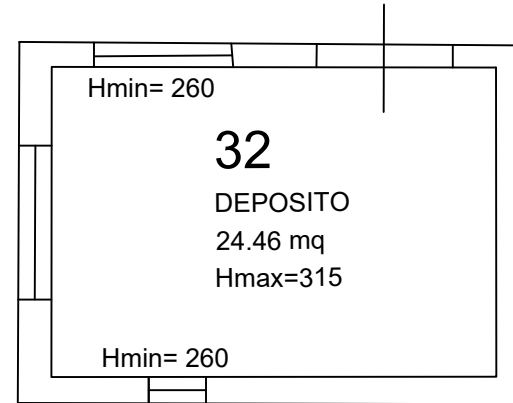

PIANO TERRA Deposito

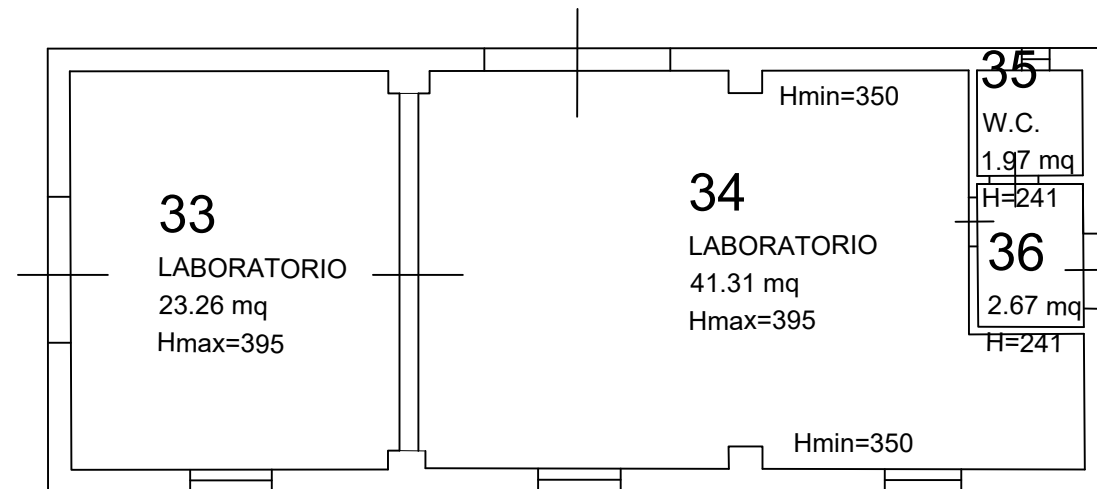

PIANO TERRA Laboratori

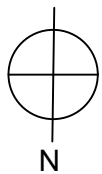

LOTTO 2
Tavola 5
Piano terra
Pianta laboratori e deposito
Scala 1:100

- Lotto 3: Borgo San Lorenzo
- Lotto 4: Scarperia

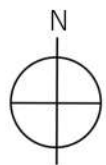
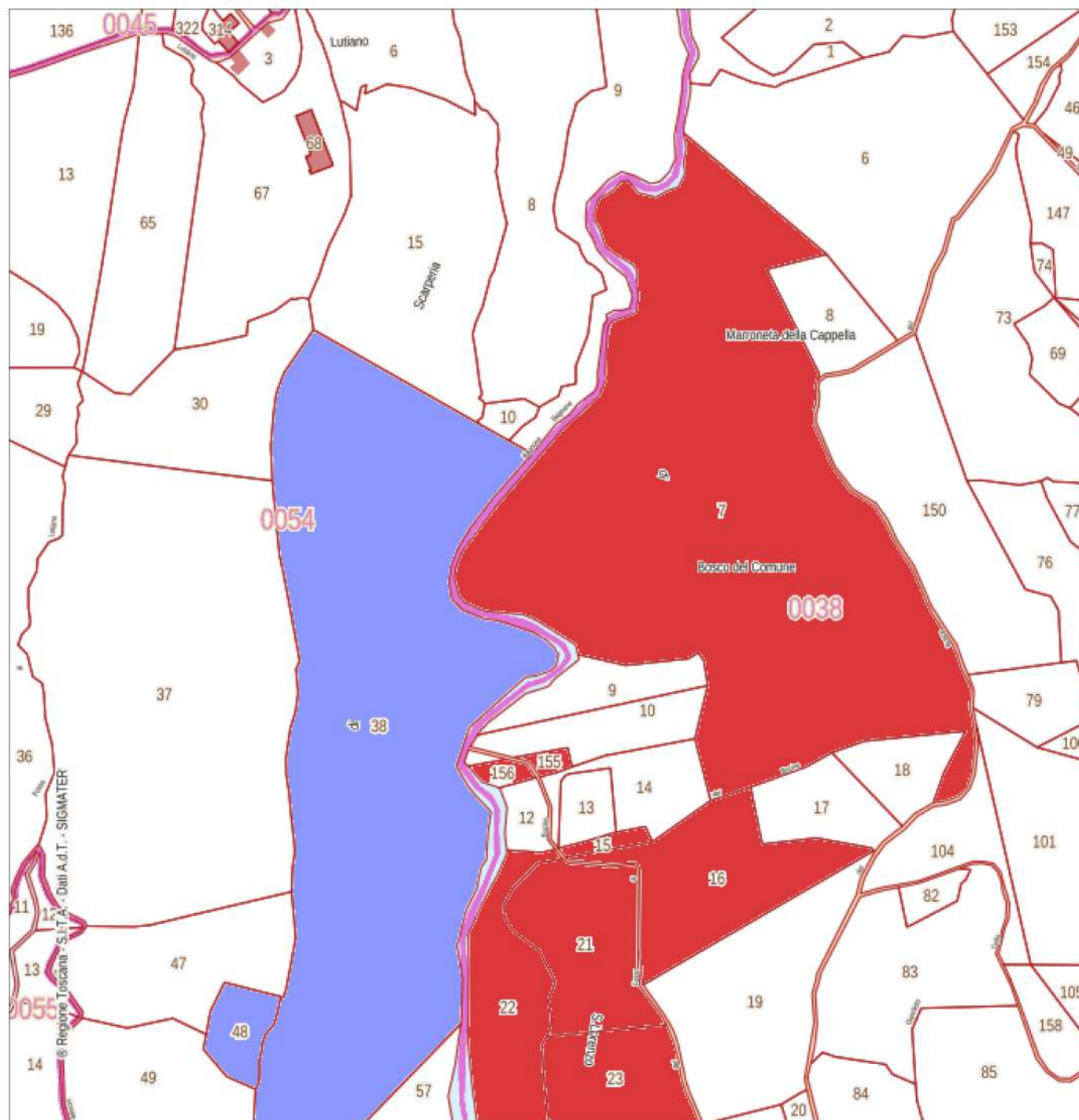

LOTTO 3-4
Tavola 2
Individuazione delle aree
Scala 1:5000

■ Lotto 3: Borgo San Lorenzo

■ Lotto 4: Scarperia

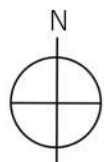
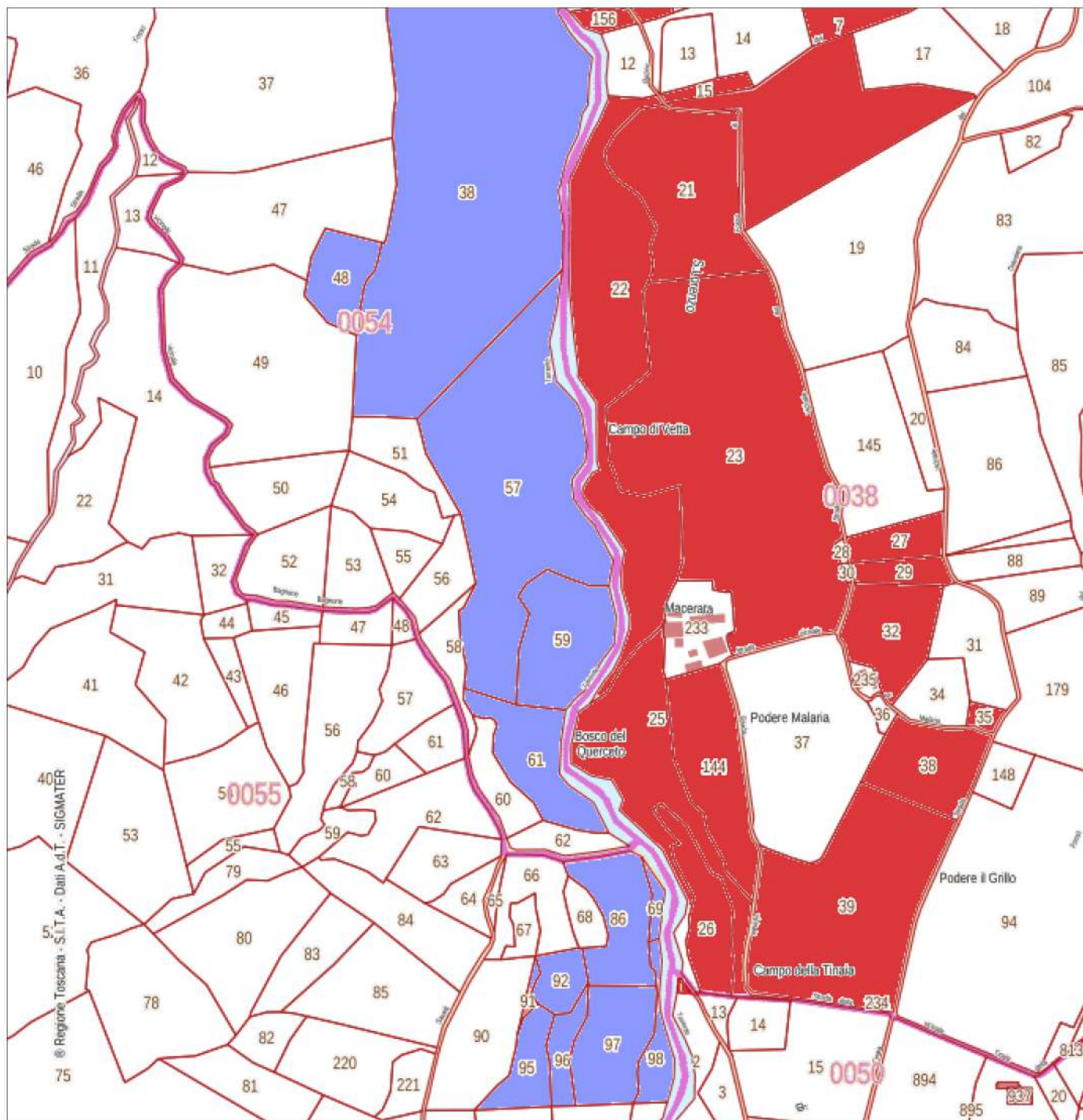

LOTTO 3-4

Tavola 3

Individuazione delle aree

Scala 1:5000