

# SCHEMA PLANIMETRICO STATO DEI LUOGHI

ALL.

F. 3 m.n. 2 sub. 17

Piano Terzo



Piano Quarto

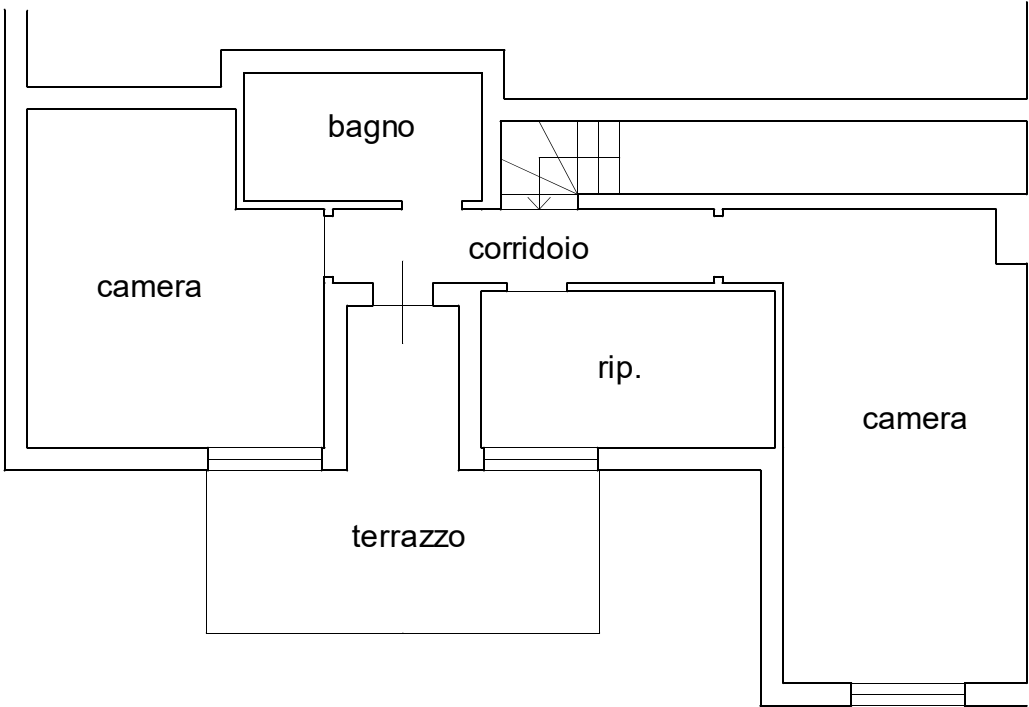

SCHEMA PLANIMETRICO  
STATO DEI LUOGHI

ALL.

F. 3 m.n. 2 sub. 86

Piano Interrato -1

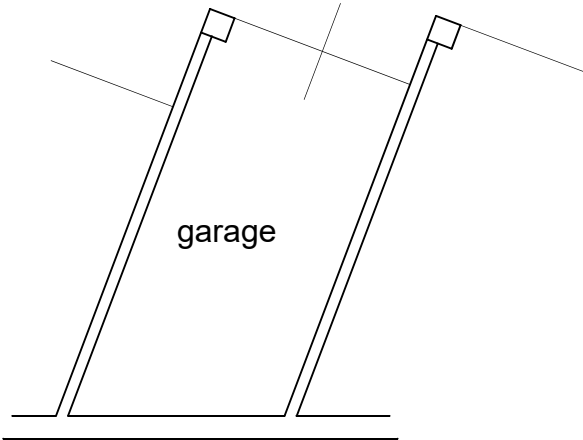

# SOVRAPPOSIZIONE STATO DEI LUOGHI-ASSENTITO

ALL.

F. 3 m.n. 2 sub. 17

Piano Terzo

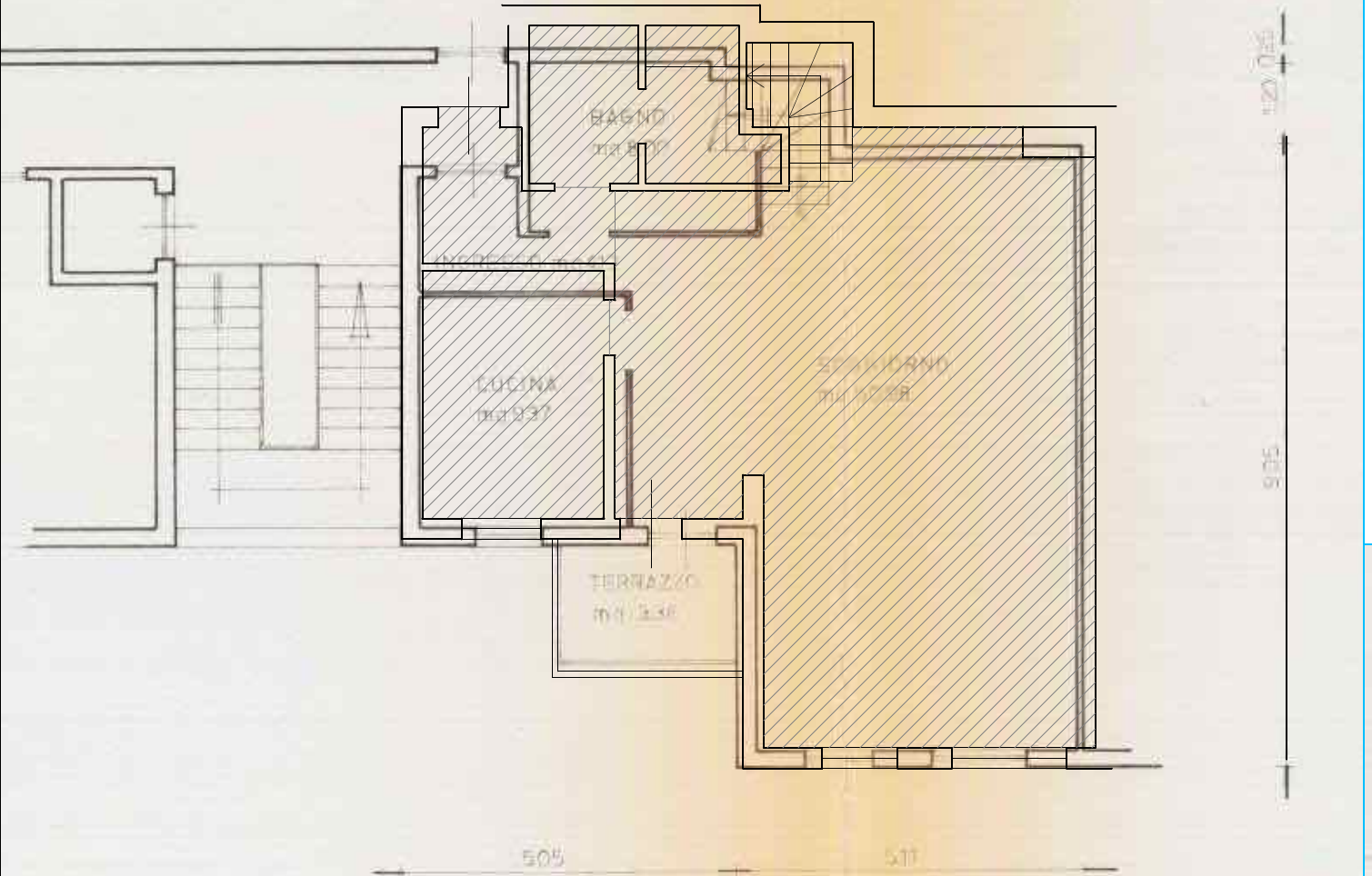

Piano Quarto

COND. ED. PROT. N° 6540  
DEL 30/04/86 N° PROC. 0660777808

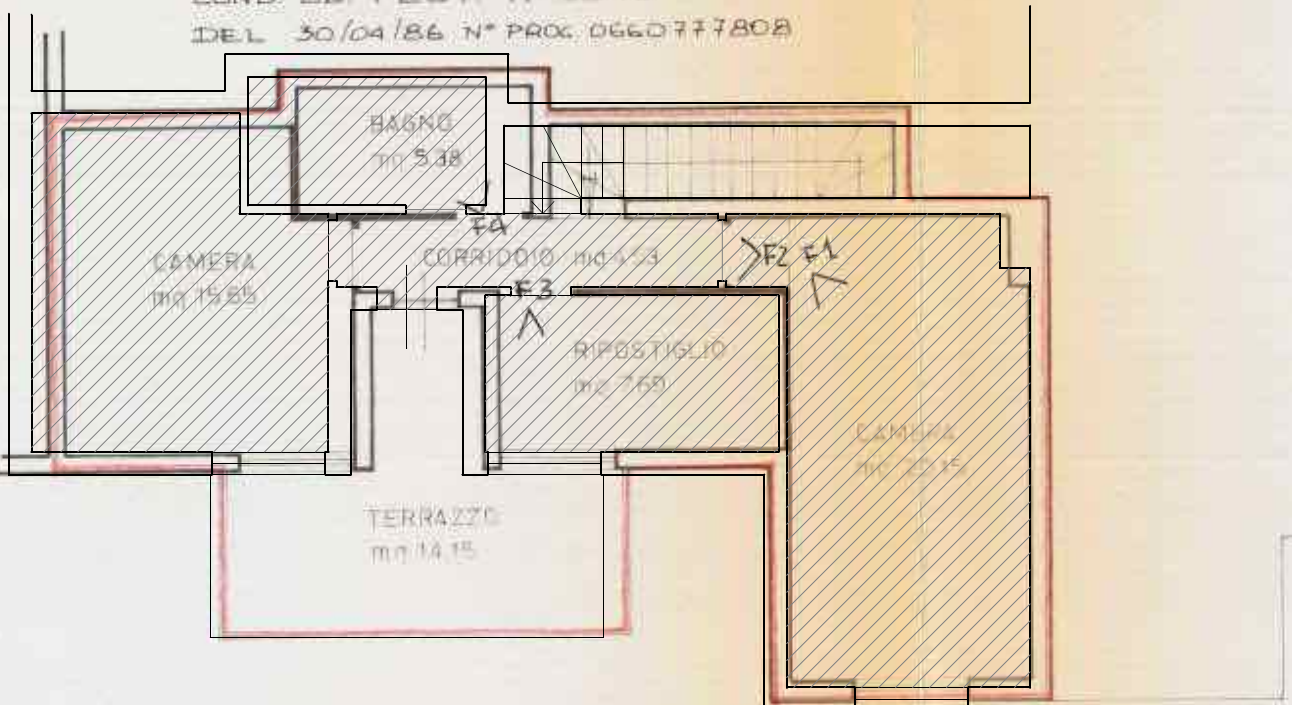

SOVRAPPOSIZIONE  
STATO DEI LUOGHI-ASSENTITO

ALL.

F. 3 m.n. 2 sub. 86

Piano Interrato -1

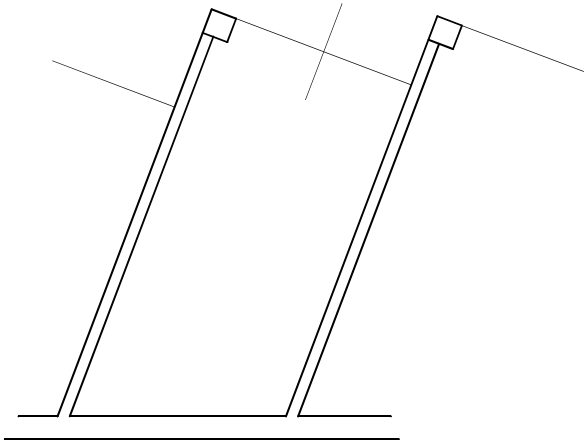

# SOVRAPPOSIZIONE STATO DEI LUOGHI-CATASTALE

ALL.

F. 3 m.n. 2 sub. 17

Piano Terzo

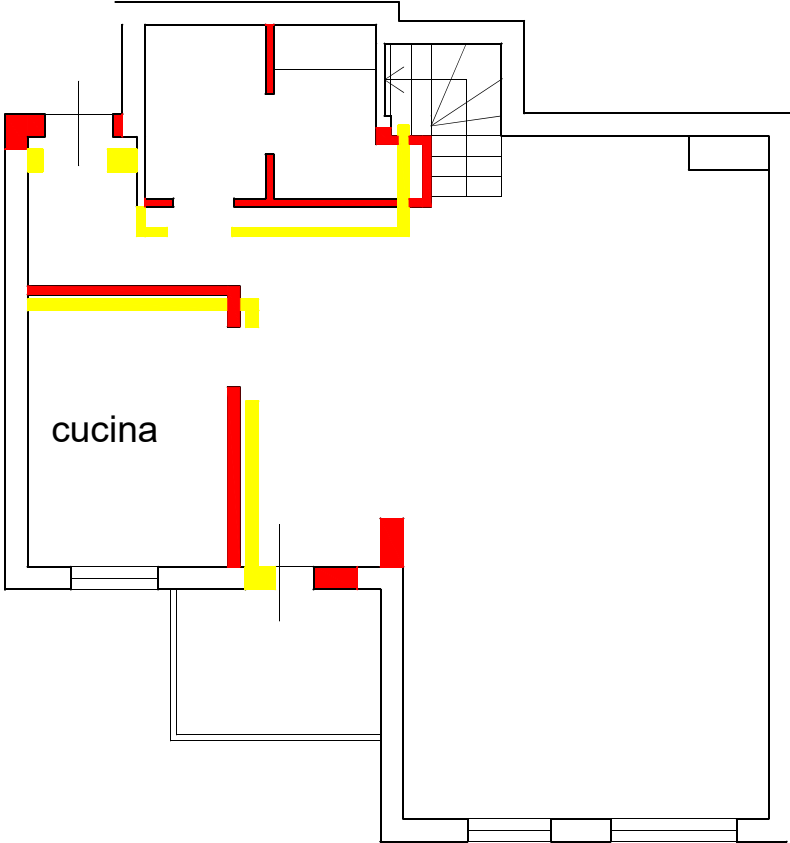

Piano Quarto

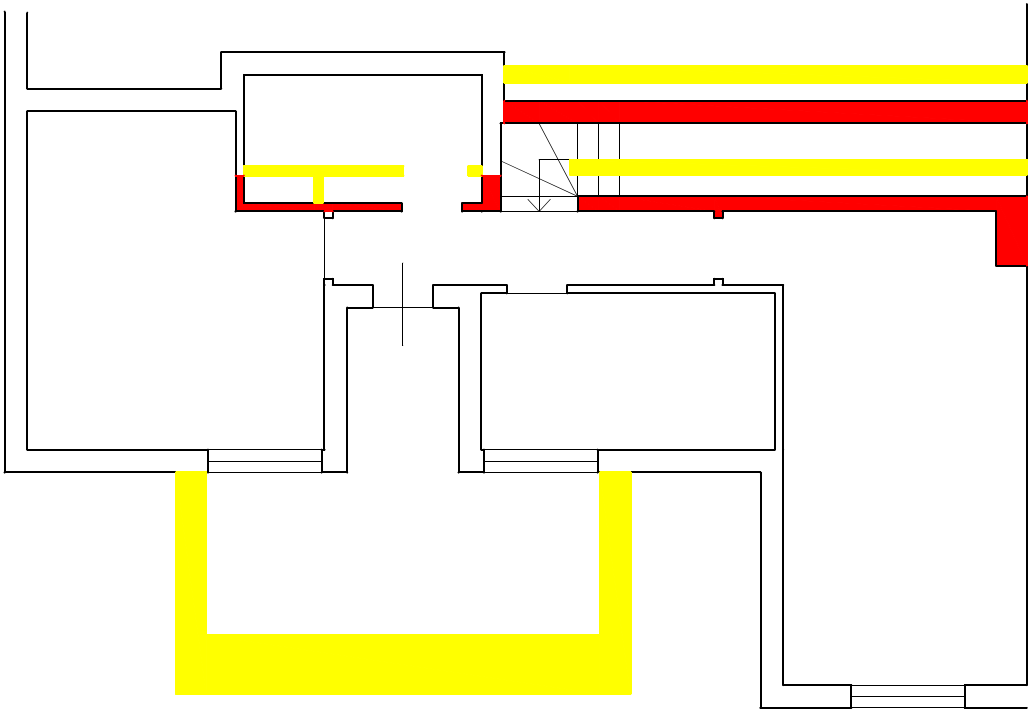

SOVRAPPOSIZIONE  
STATO DEI LUOGHI-CATASTALE

ALL.

F. 3 m.n. 2 sub. 86

Piano Interrato -1

