

PIANO TERRA

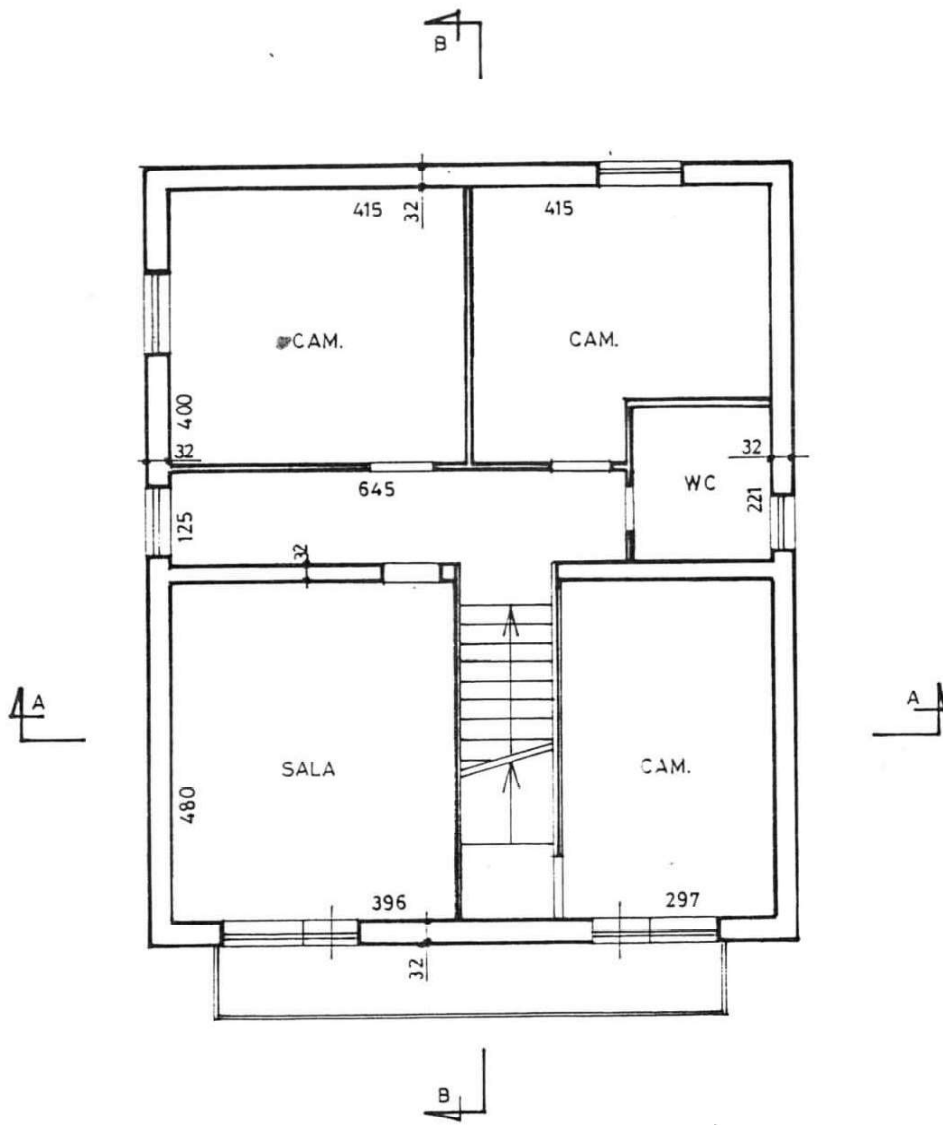

PIANO PRIMO

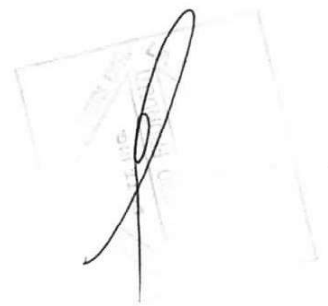

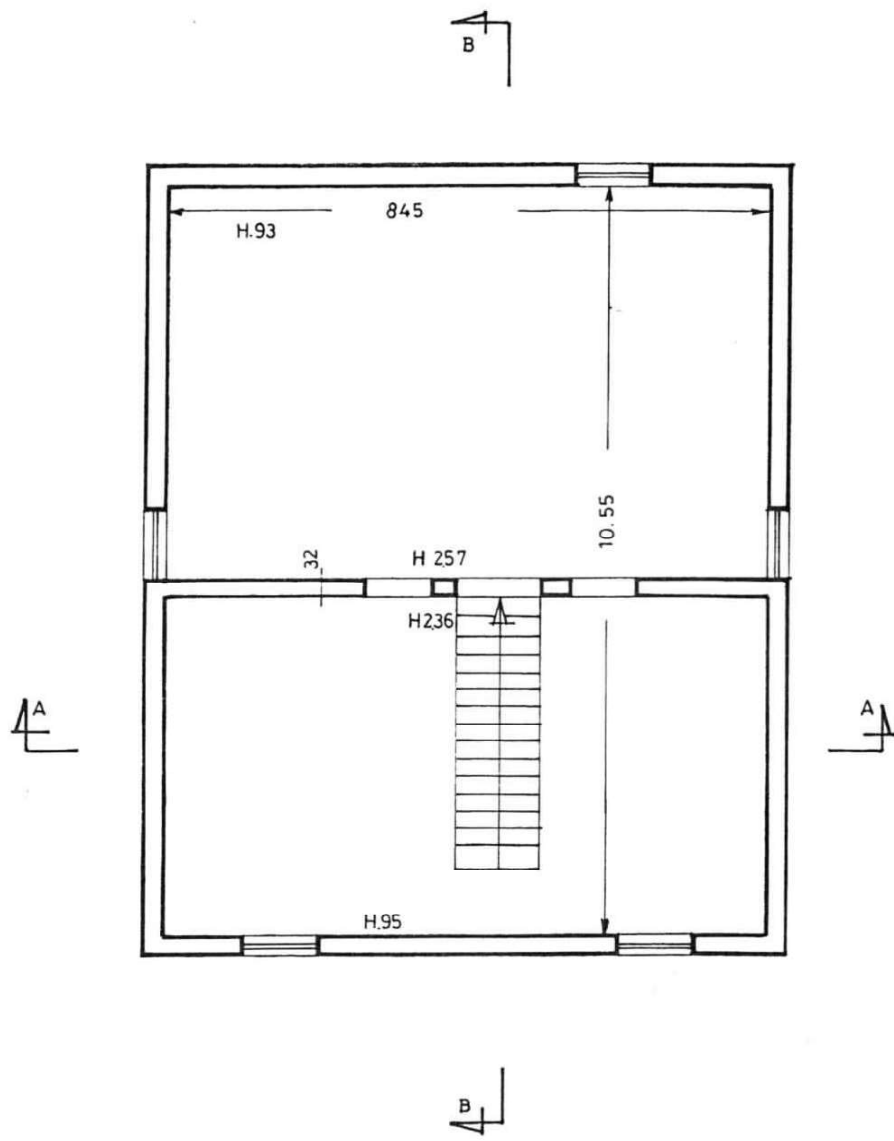

PIANO SOFFITTA

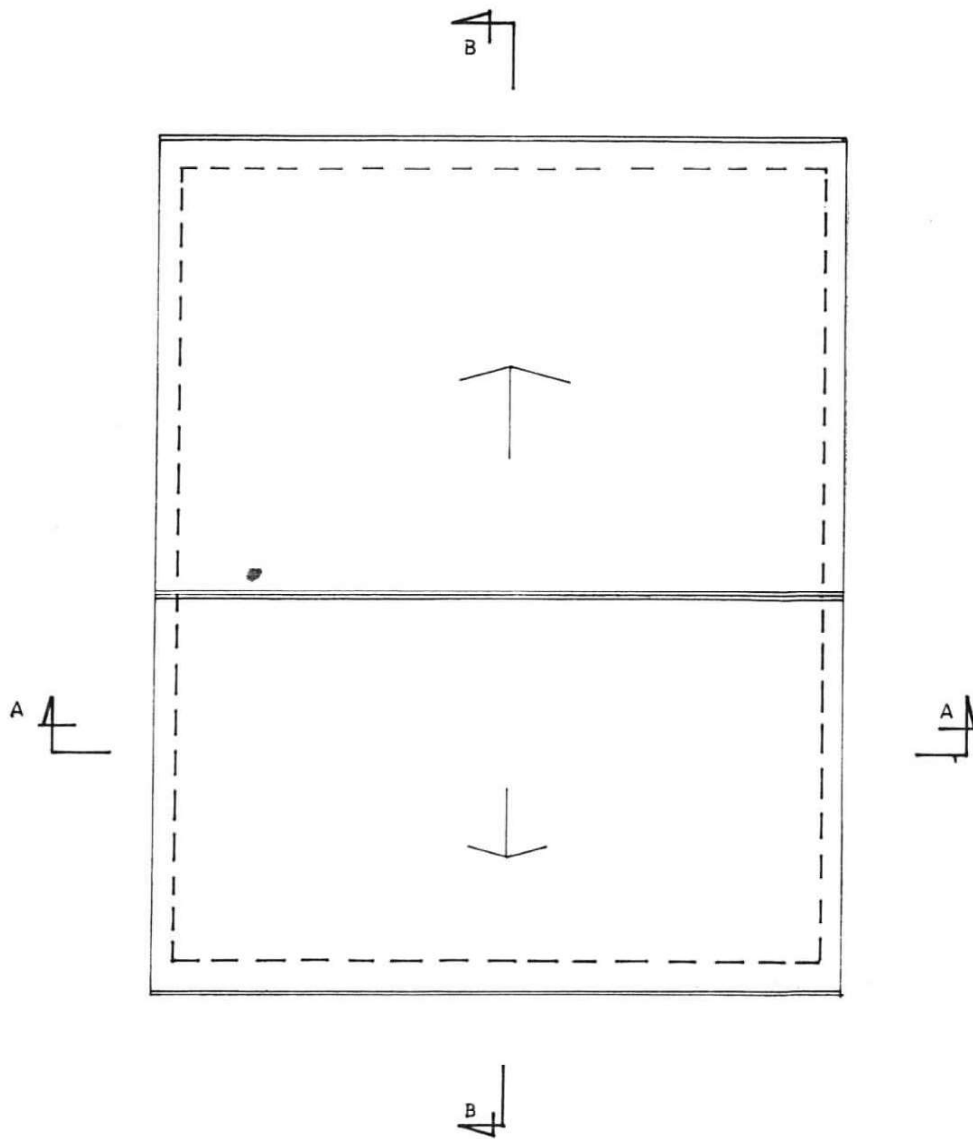

PIANO COPERTURA

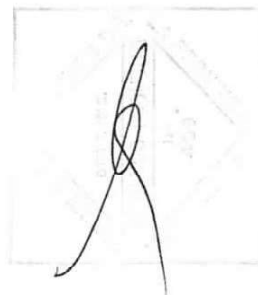

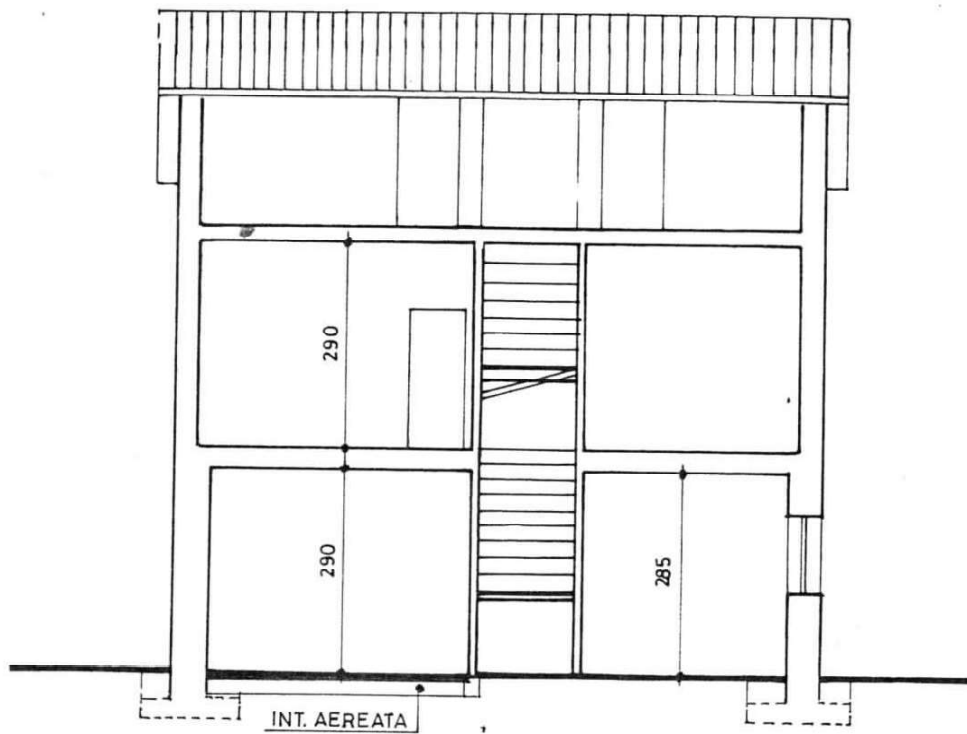

SEZIONE A-A

A handwritten signature or mark, possibly a stylized 'S' or 'A', is located in the lower right quadrant of the page. It is drawn with a single continuous line and is enclosed within a faint rectangular border.

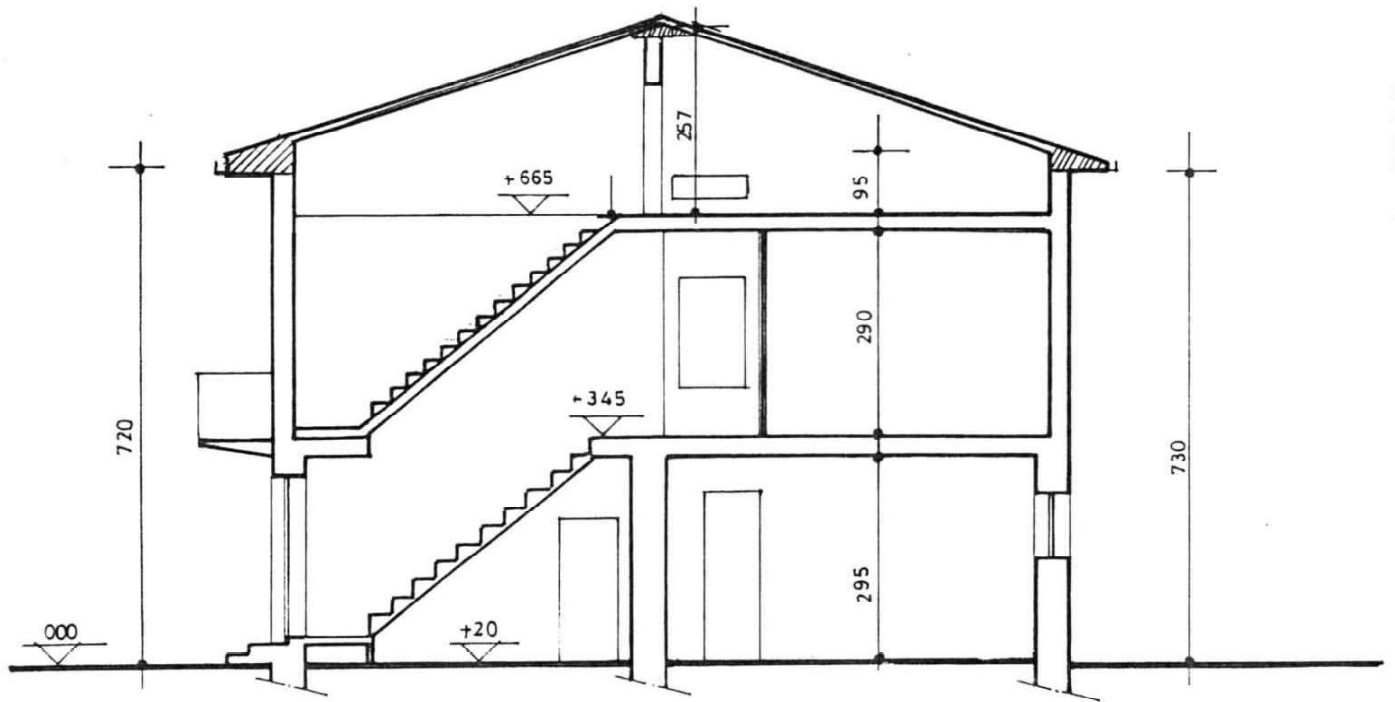

SEZIONE B-B

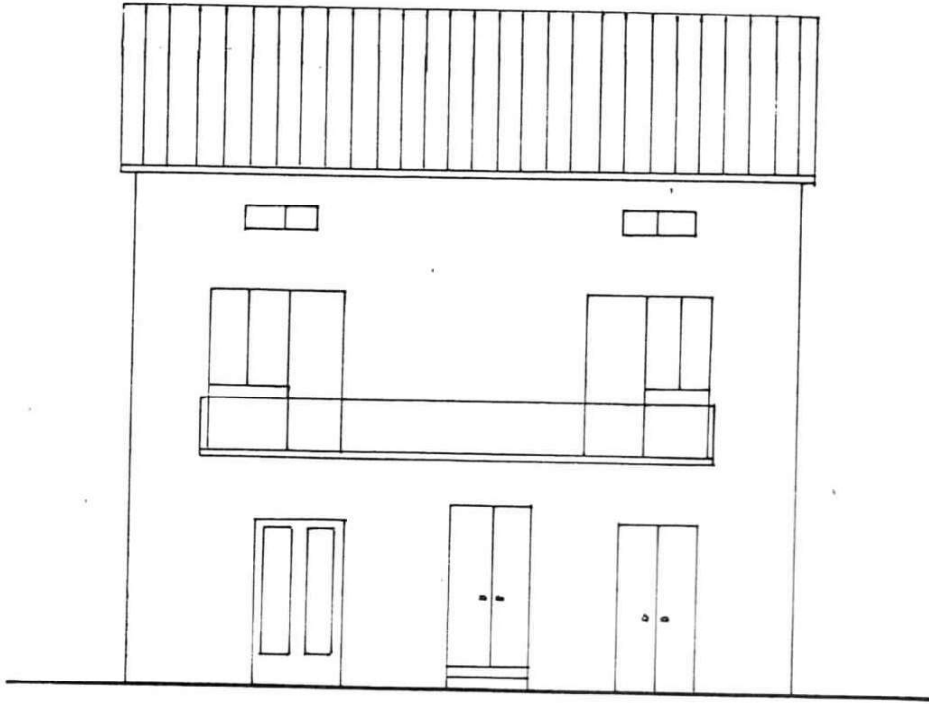

PROSPETTO ANTERIORE

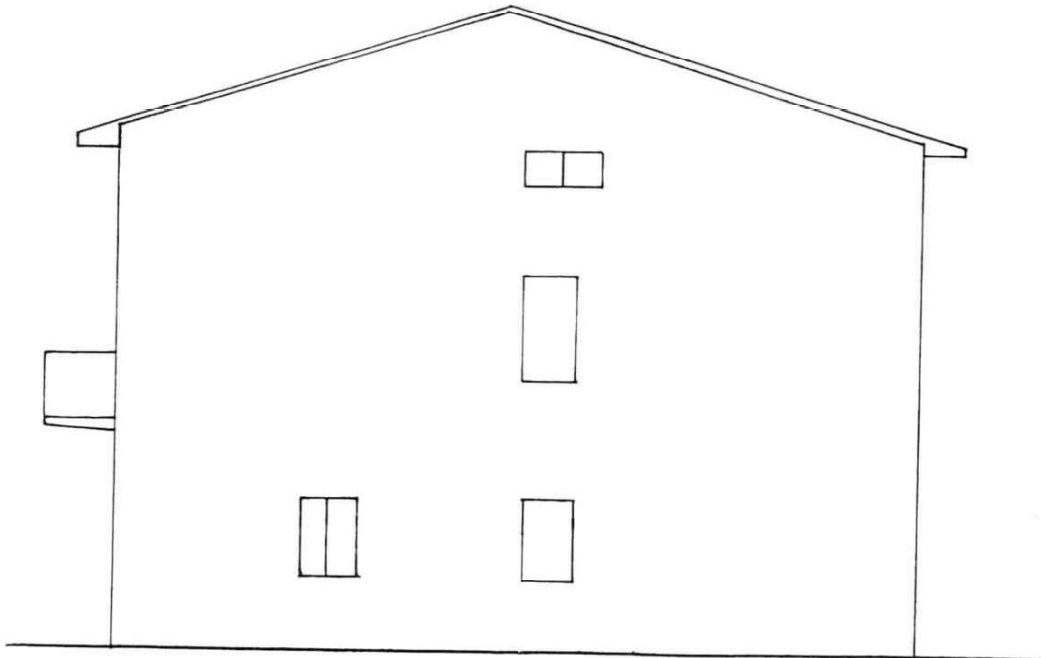

FIANCO DX

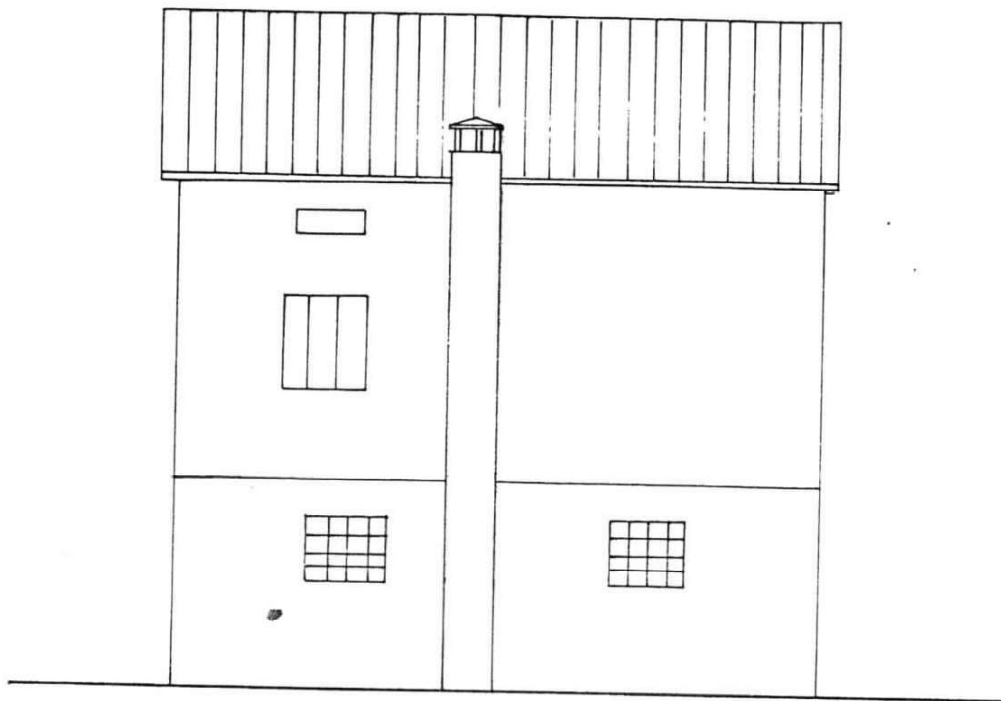

PROSPETTO POSTERIORE

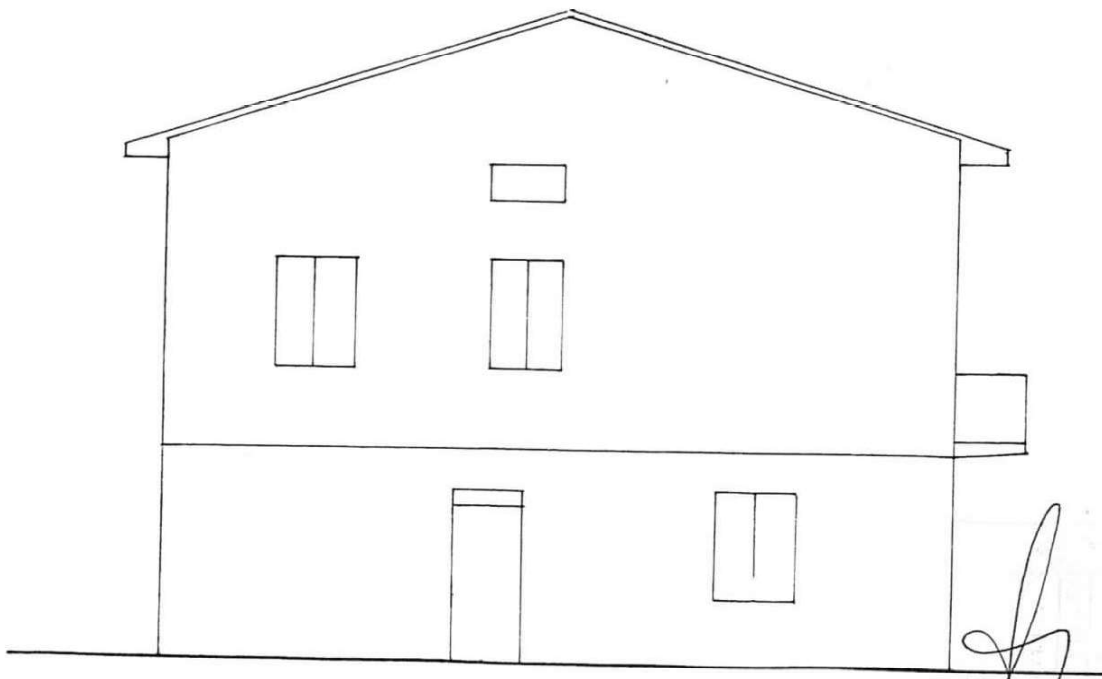

FIANCO SX

