

Allegato 5

PLANIMETRIA RILEVATA DEL BENE



PLANIMETRIA CATASTALE
fg. 37, p.lla 1814, sub 1
scala 1:100

PIANO SEMINTERRATO

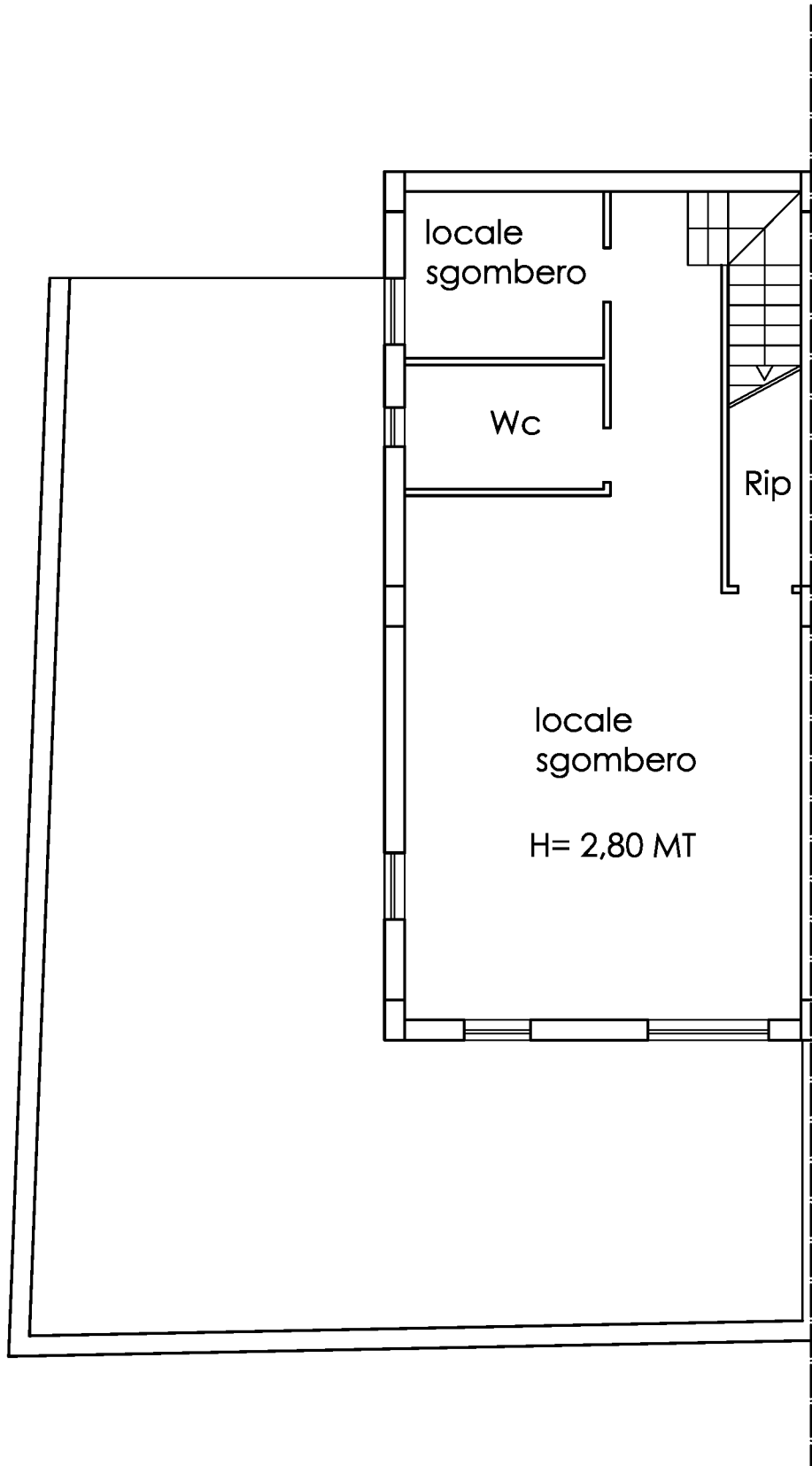

PLANIMETRIA CATASTALE QUOTATA

fig. 37, p.lla 1814, sub 1

scala 1:100

PIANO SEMINTERRATO

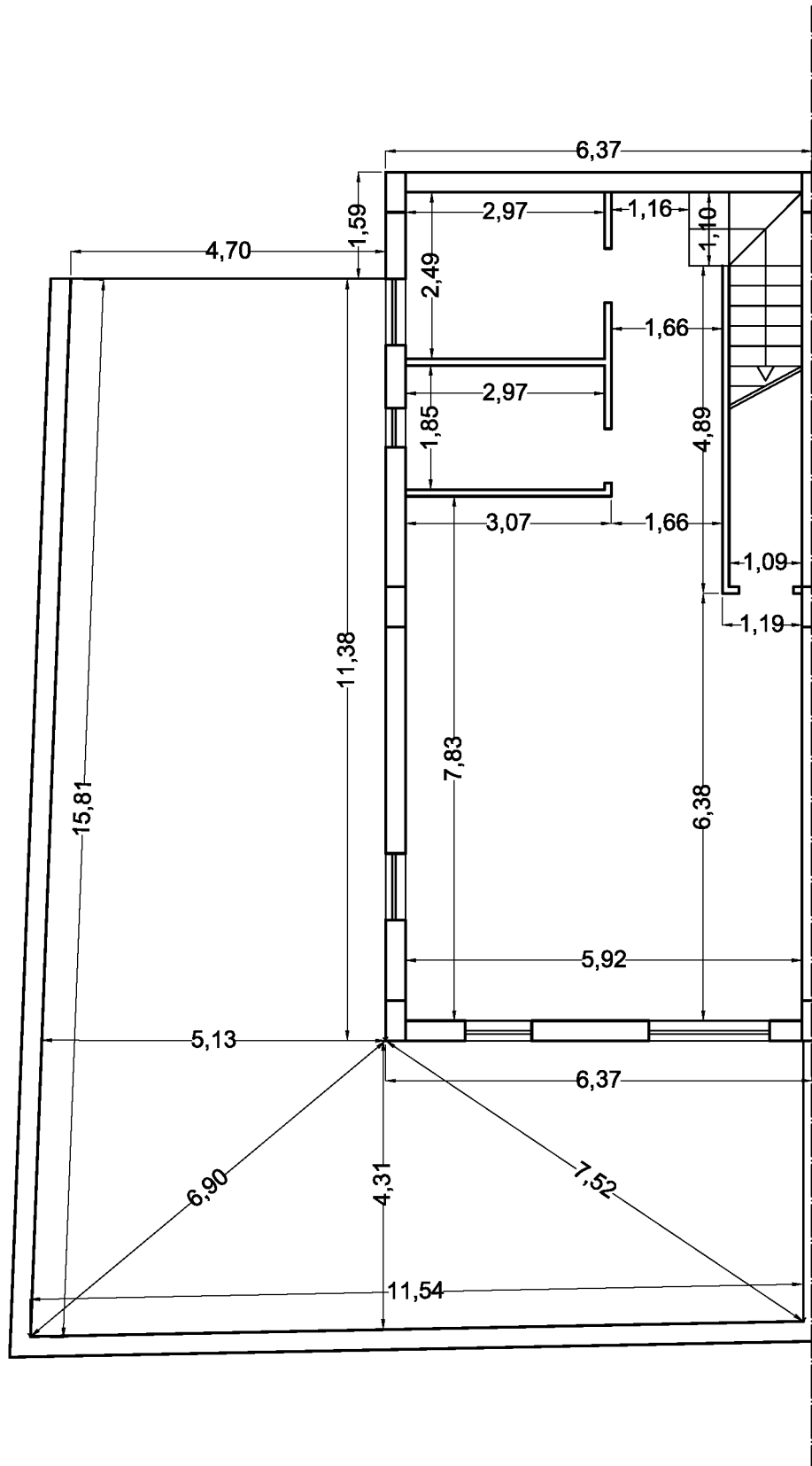

CALCOLO SUPERFICI CATASTALI
fig. 37, p.lla 1814, sub 1
scala 1:100

PIANO SEMINTERRATO

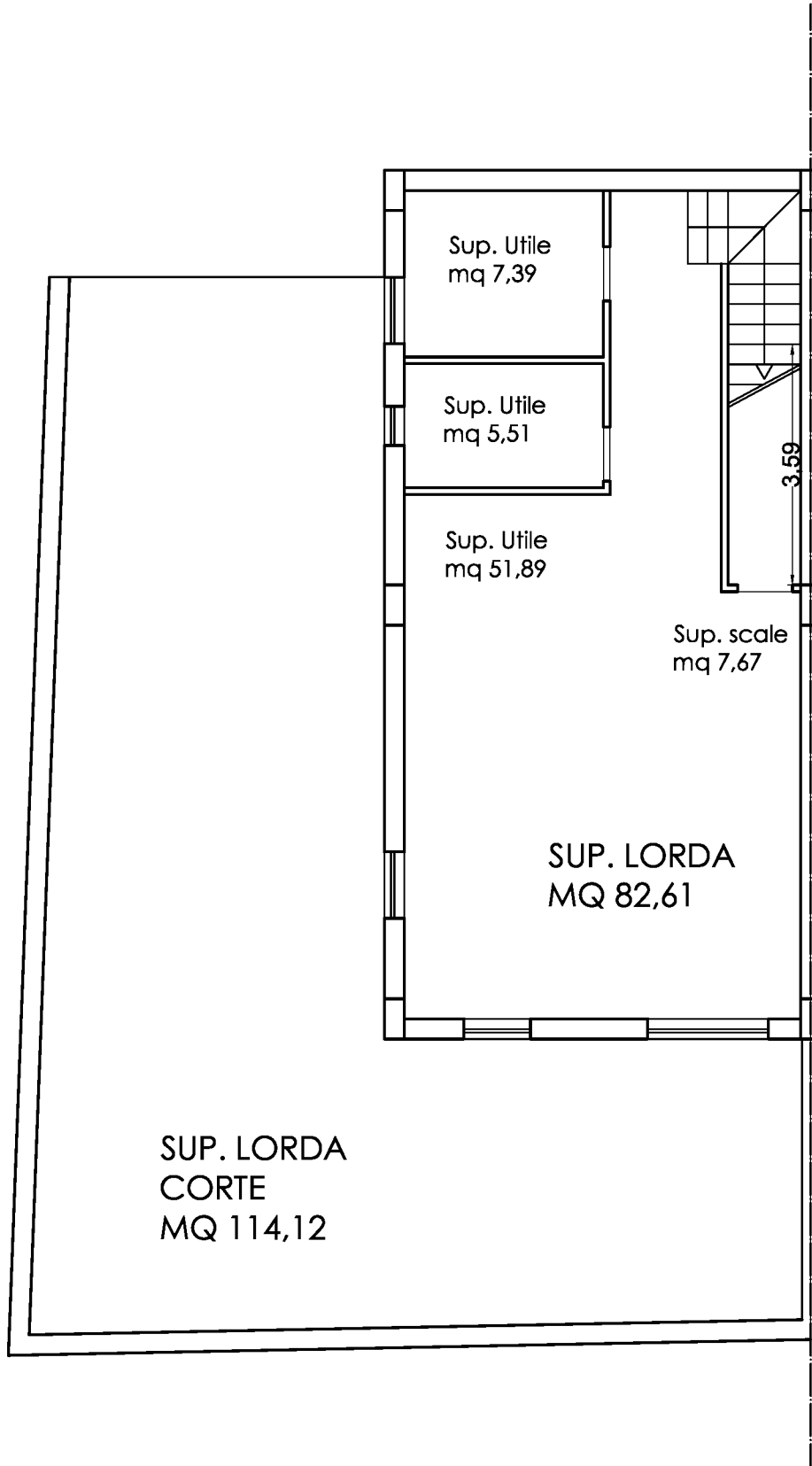

PLANIMETRIA DI PROGETTO

fg. 37, p.lla 1814, sub 1

scala 1:100

PIANO SEMINTERRATO

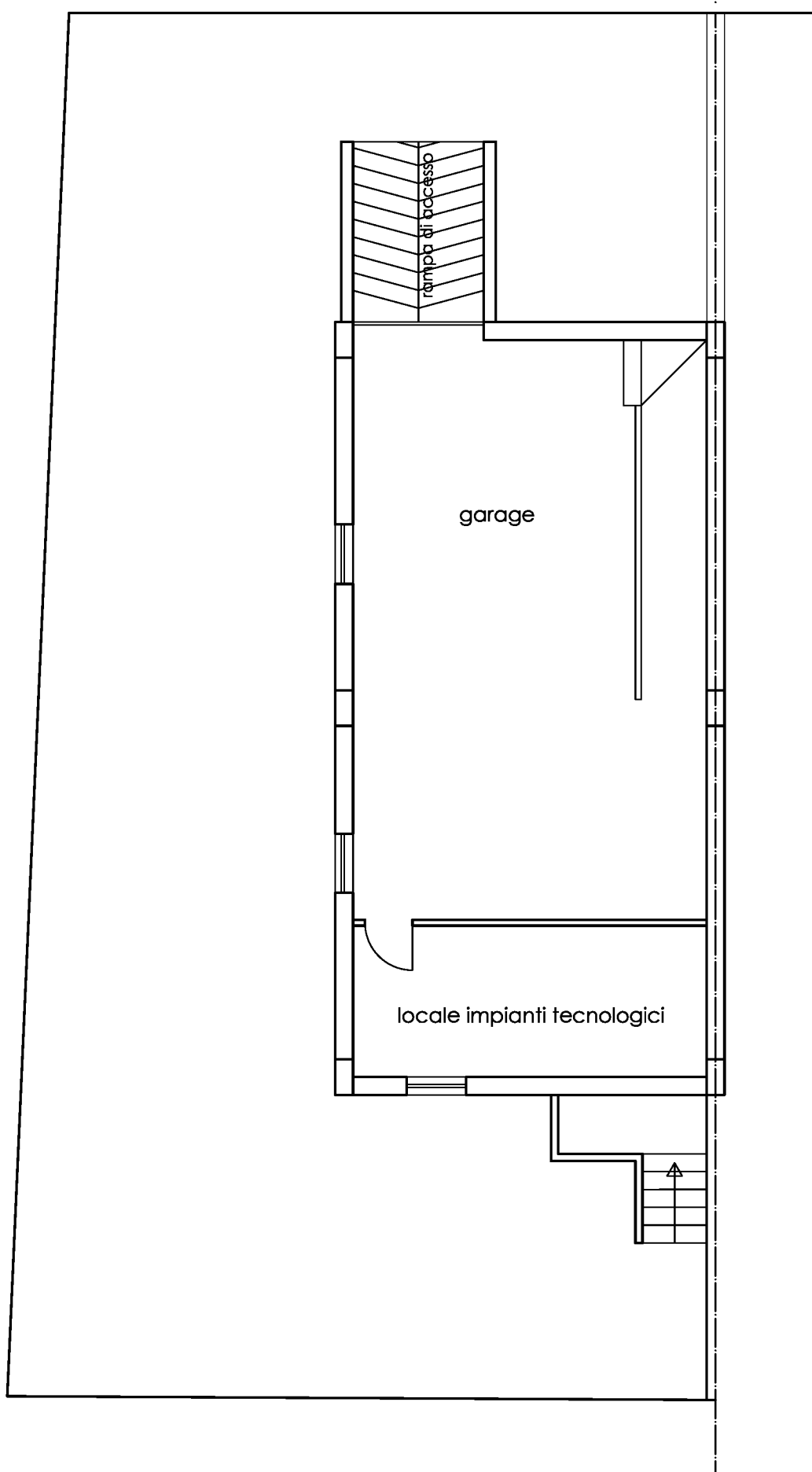

PLANIMETRIA DI PROGETTO QUOTATA

fig. 37, p.lla 1814, sub 1

scala 1:100

PIANO SEMINTERRATO

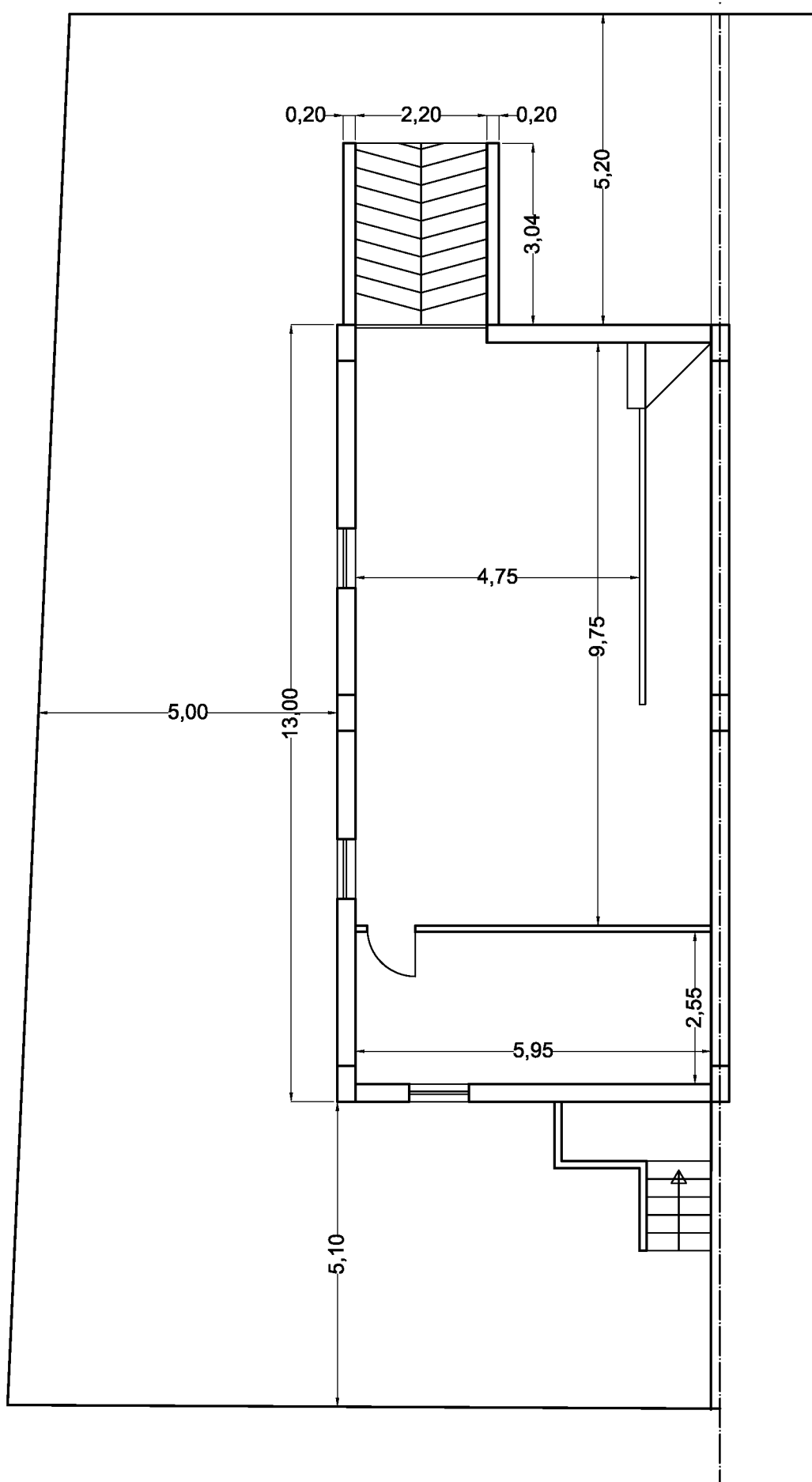

CALCOLO SUPERFICI DI PROGETTO

fg. 37, p.lla 1814, sub 1

scala 1:100

PIANO SEMINTERRATO

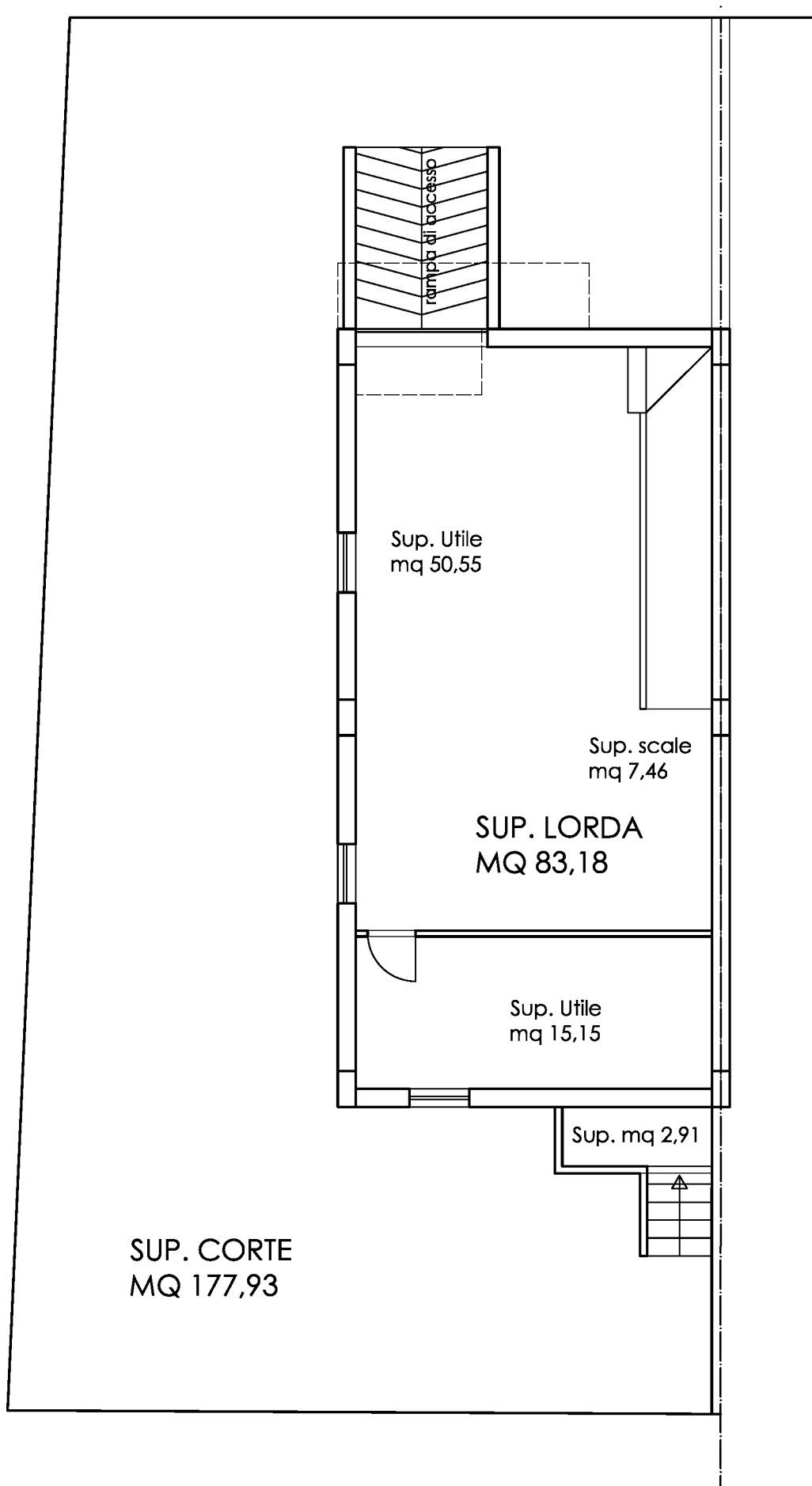

PLANIMETRIA RILEVATA
fg. 37, p.lla 1814, sub 1
scala 1:100

PIANO SEMINTERRATO

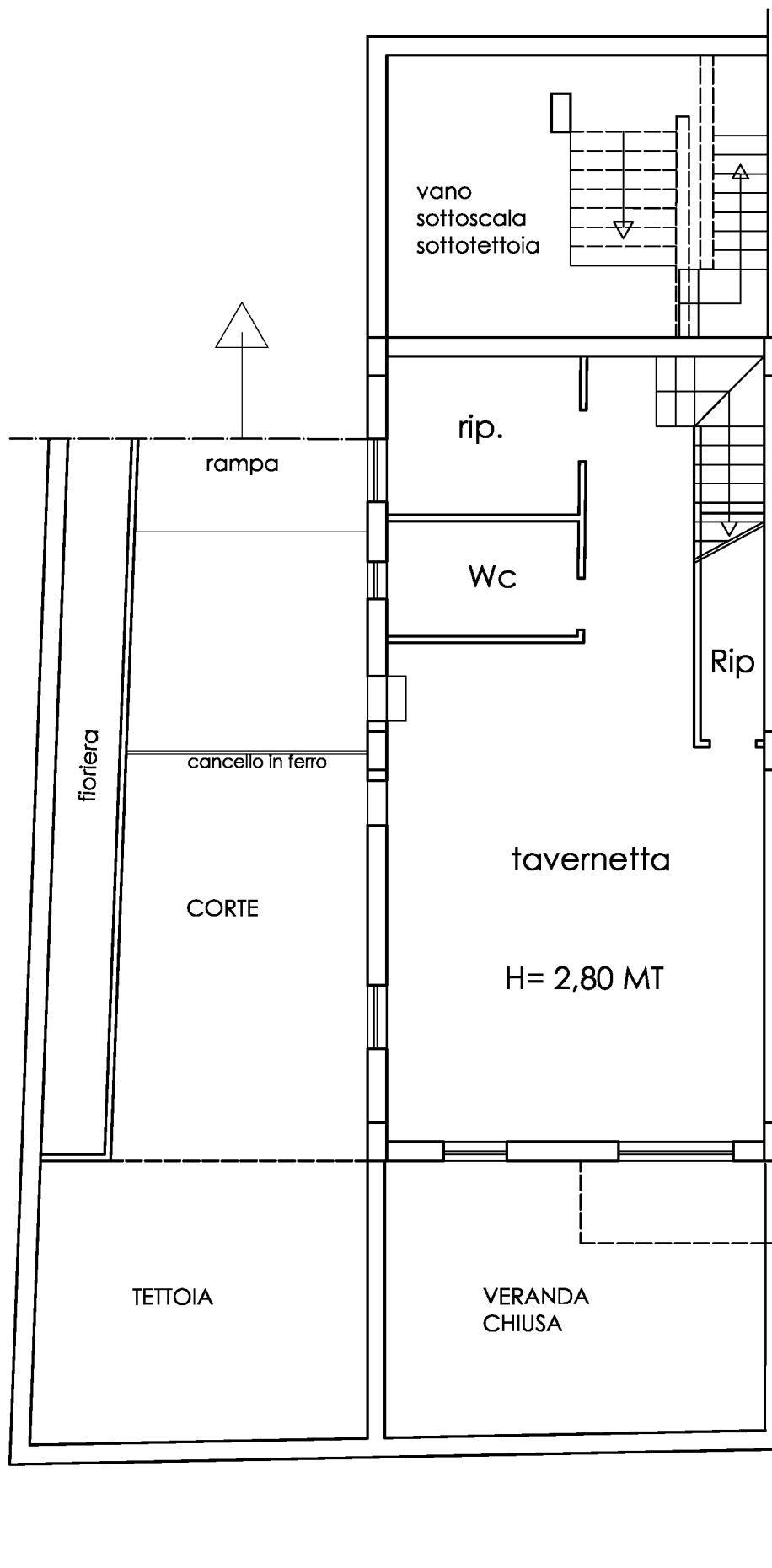

PLANIMETRIA RILEVATA QUOTATA

fg. 37, p.lla 1814, sub 1

scala 1:100

PIANO SEMINTERRATO

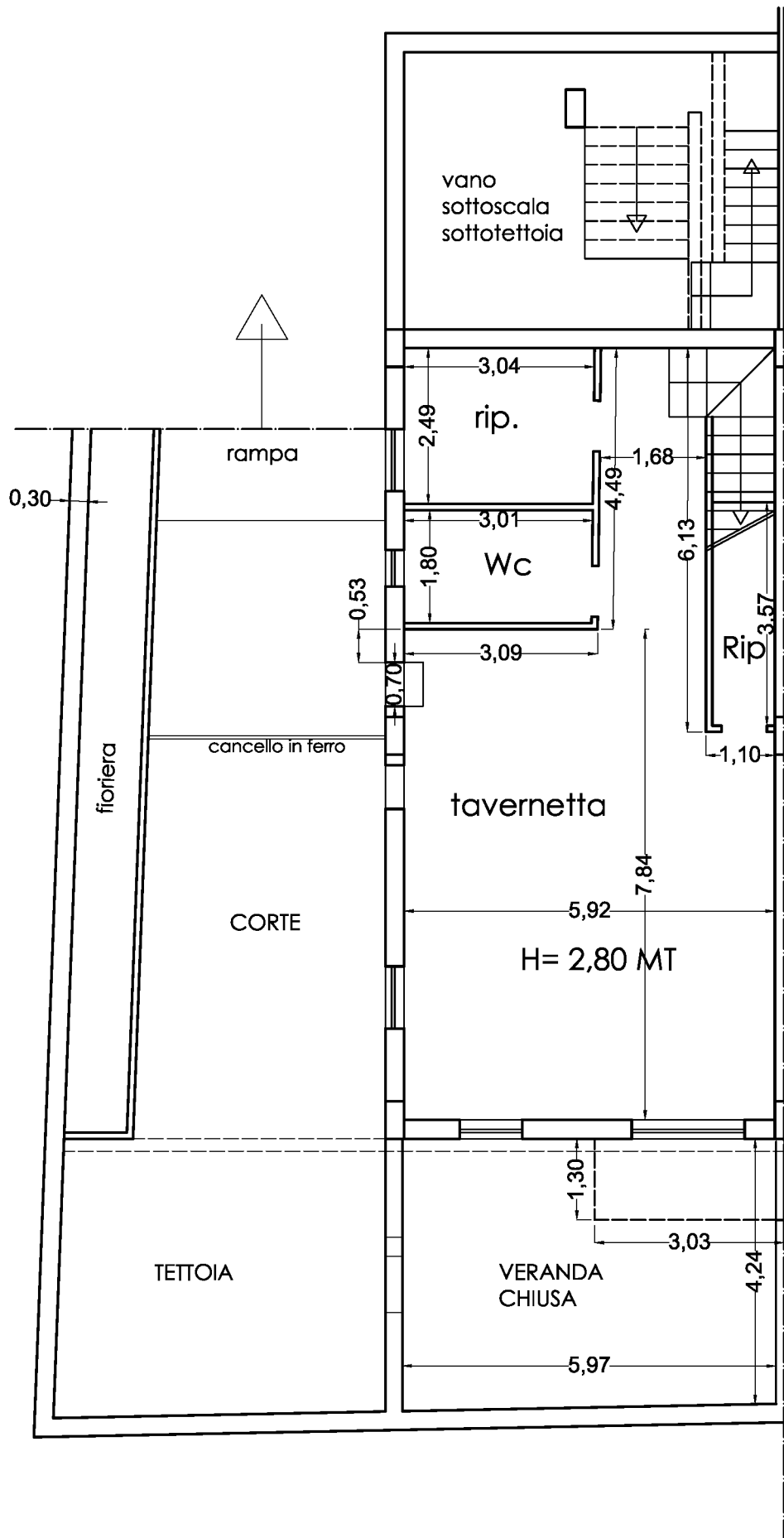

CALCOLO SUPERFICI RILEVATE

fg. 37, p.lla 1814, sub 1

scala 1:100

PIANO SEMINTERRATO

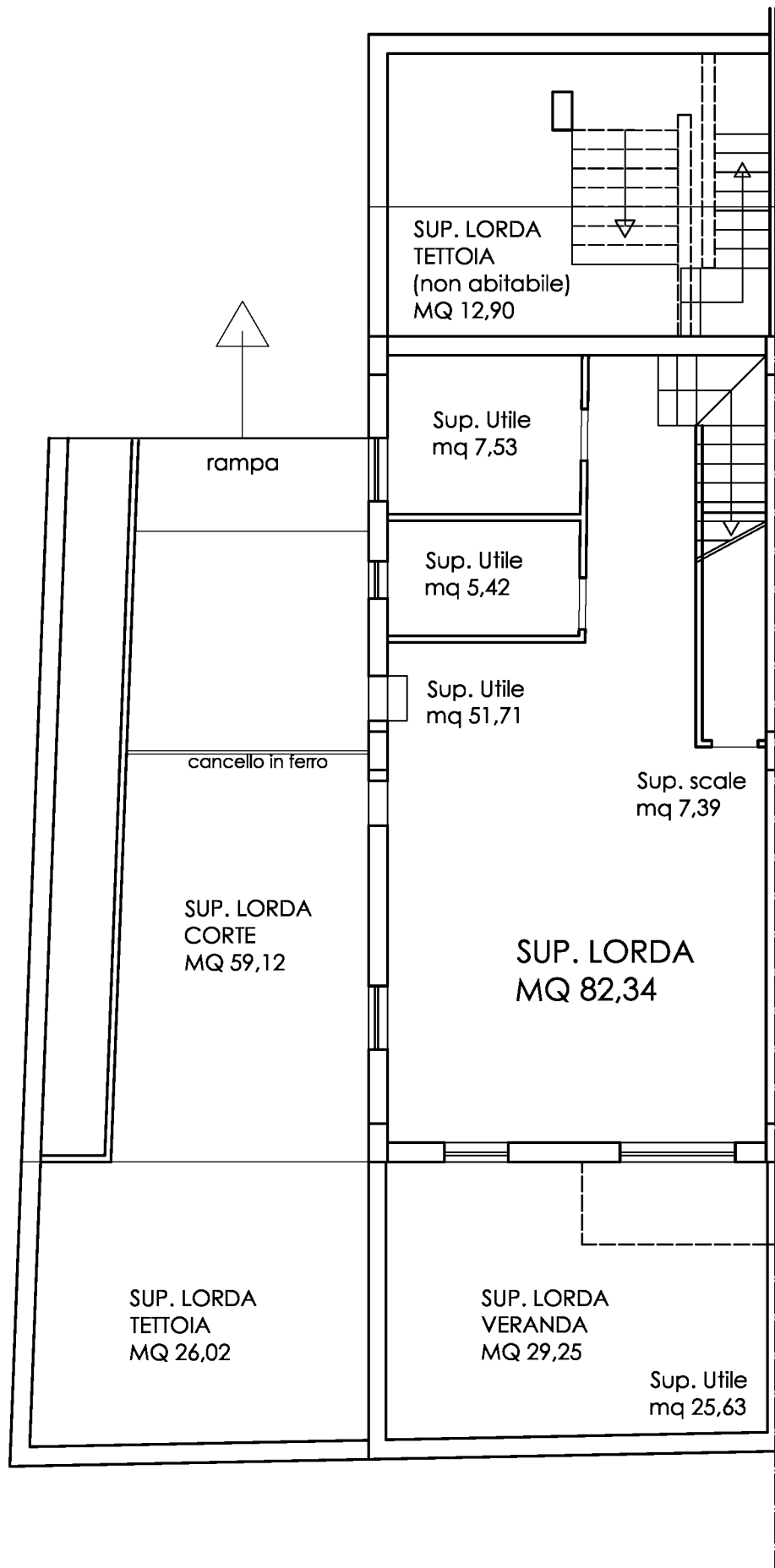

PLANIMETRIA CATASTALE
fg. 37, p.lla 1814, sub 1
scala 1:100

PIANO TERRA

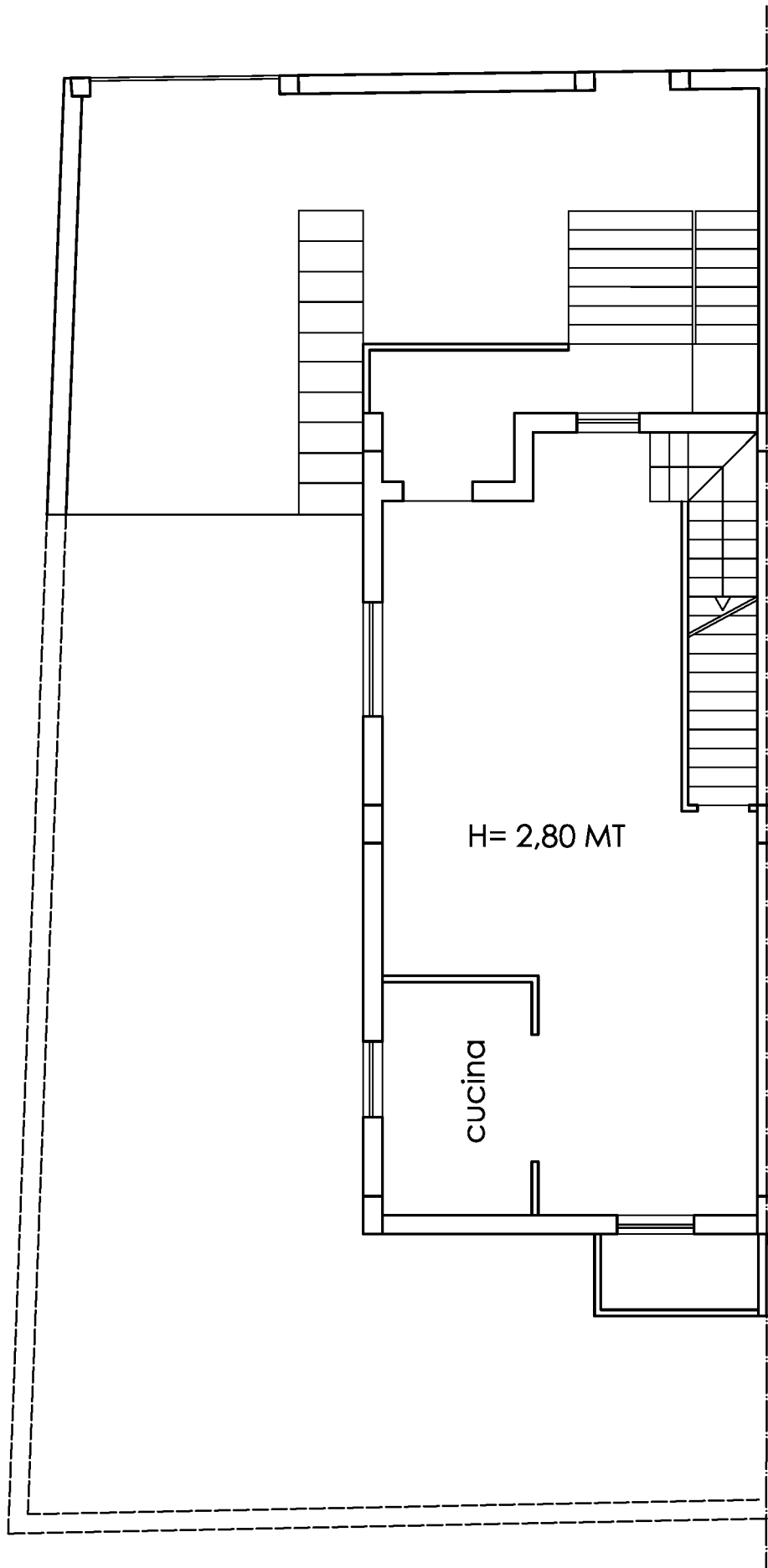

PLANIMETRIA CATASTALE QUOTATA

fig. 37, p.lla 1814, sub 1

scala 1:100

PIANO TERRA

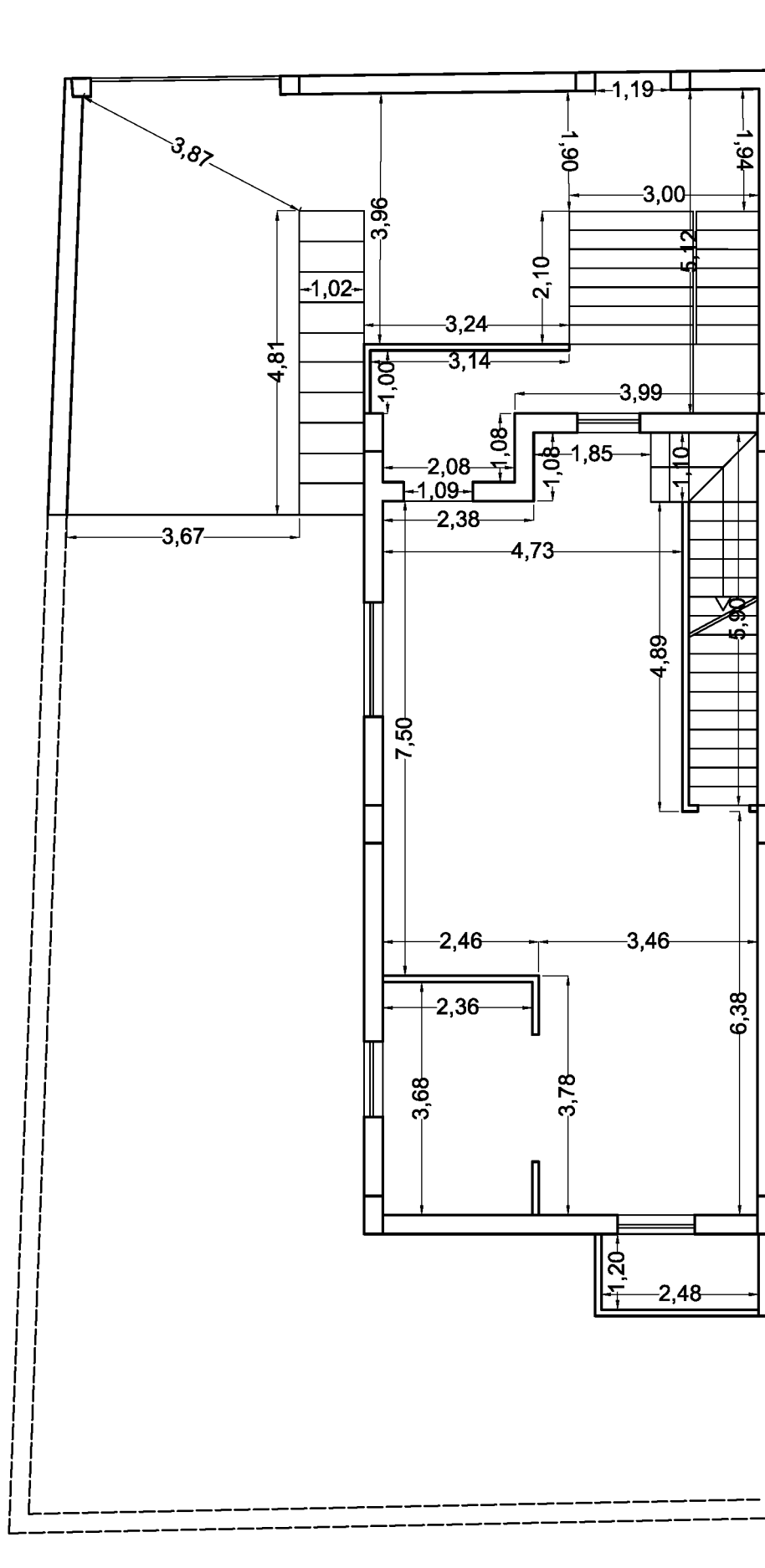

CALCOLO SUPERFICI CATASTALI

fg. 37, p.lla 1814, sub 1

scala 1:100

PIANO TERRA

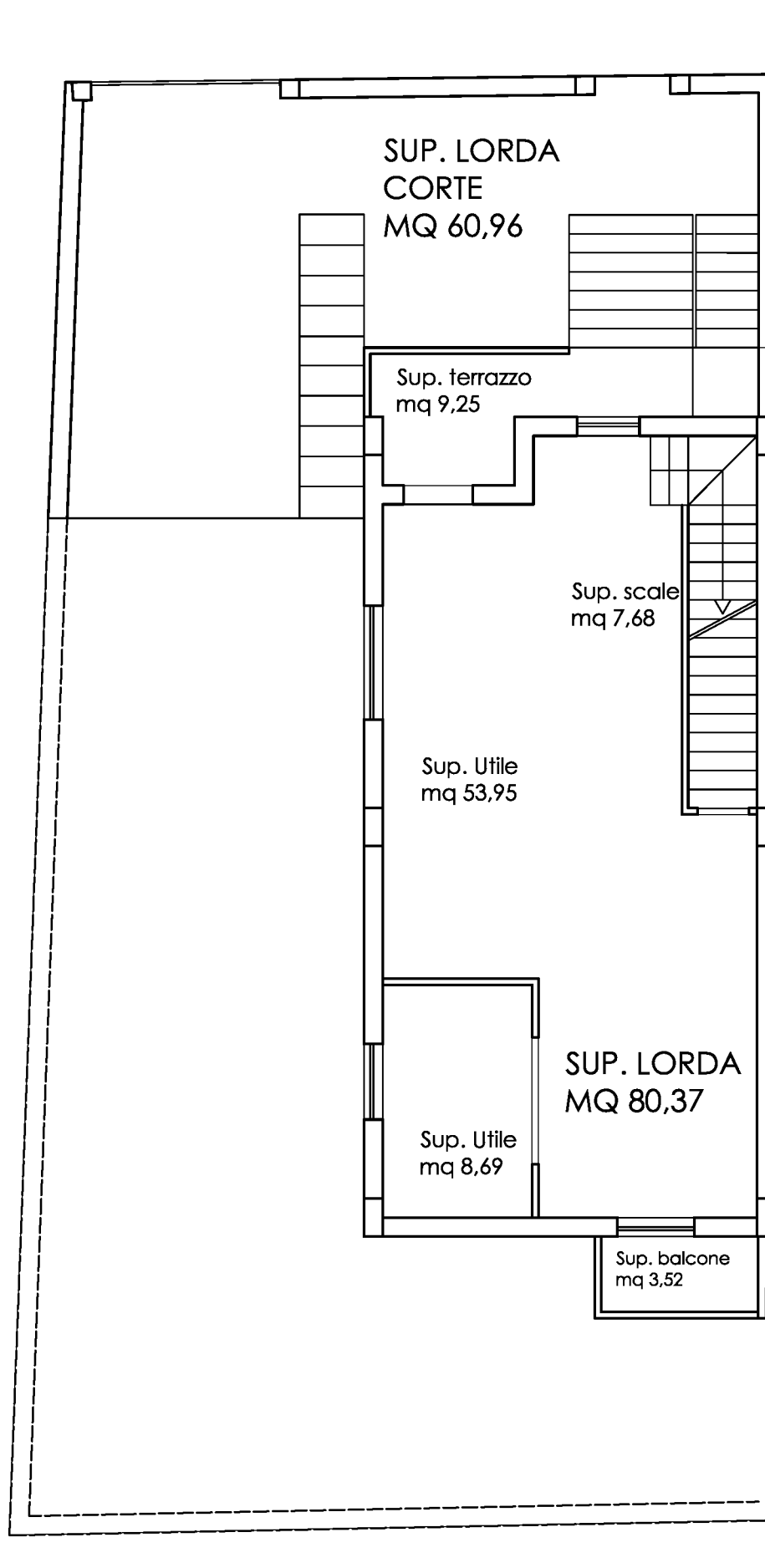

PLANIMETRIA DI PROGETTO
fg. 37, p.lla 1814, sub 1
scala 1:100

PIANO TERRA

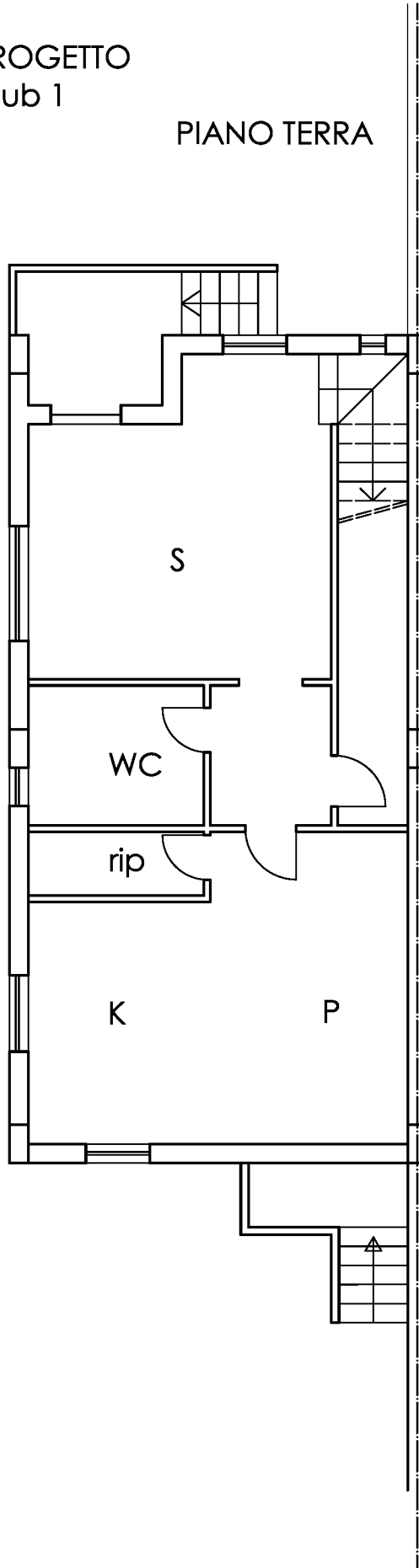

PLANIMETRIA DI PROGETTO QUOTATA
fg. 37, p.lla 1814, sub 1
scala 1:100

PIANO TERRA

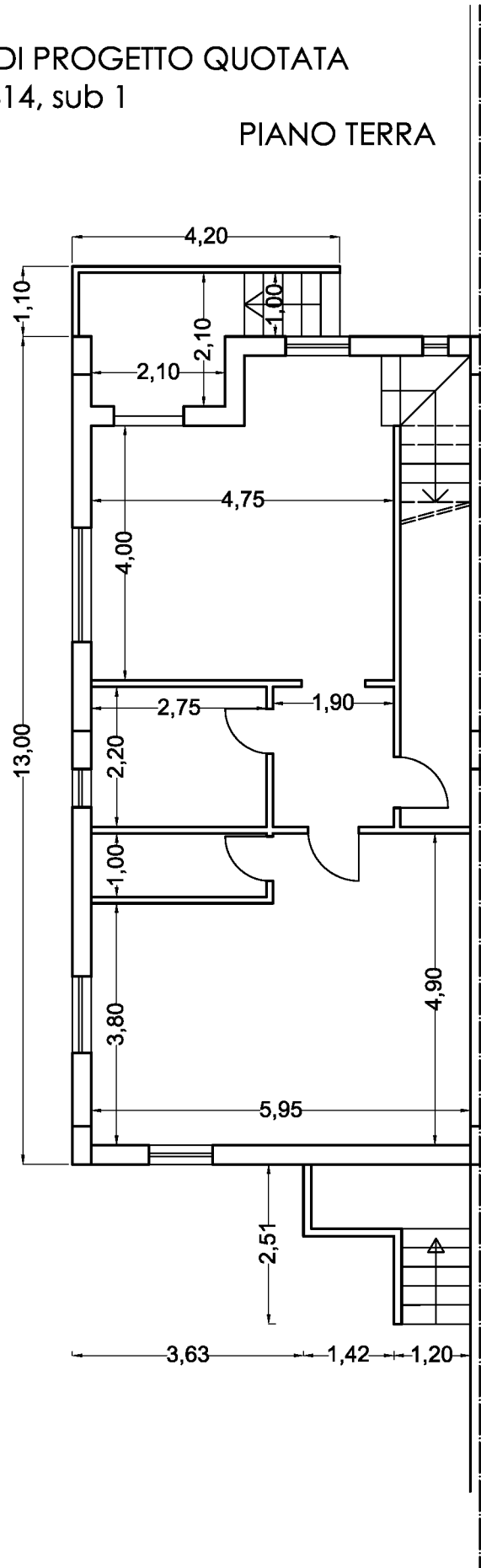

CALCOLO SUPERFICI DI PROGETTO

fg. 37, p.lla 1814, sub 1

scala 1:100

PIANO TERRA

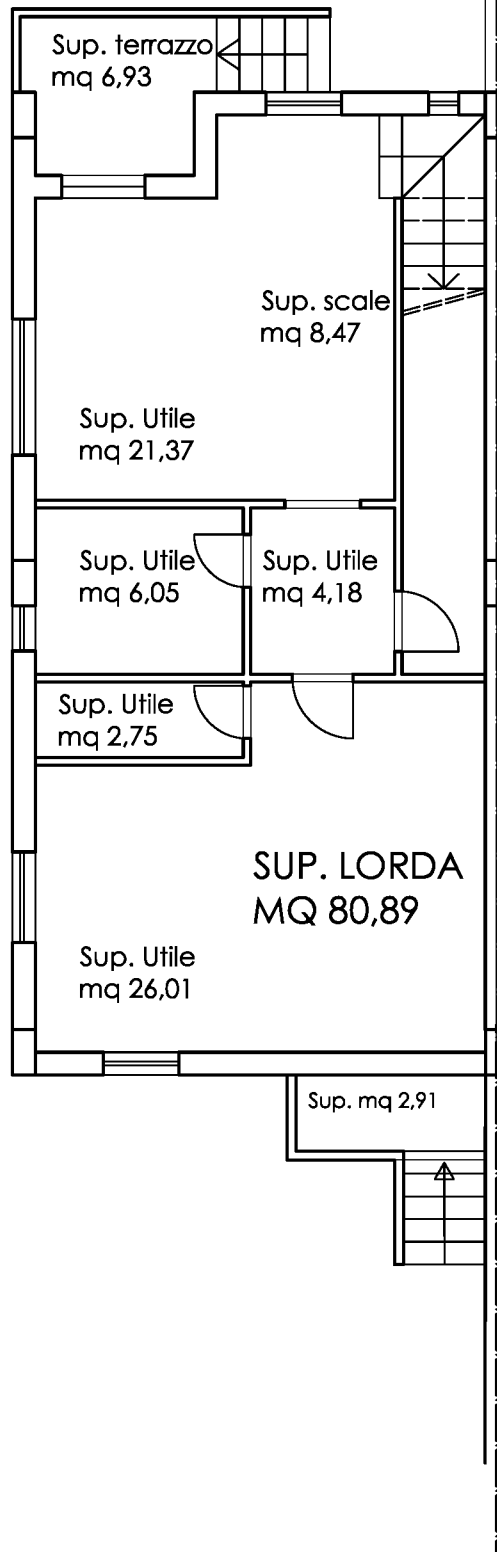

PLANIMETRIA RILEVATA
fg. 37, p.lla 1814, sub 1
scala 1:100

PIANO TERRA

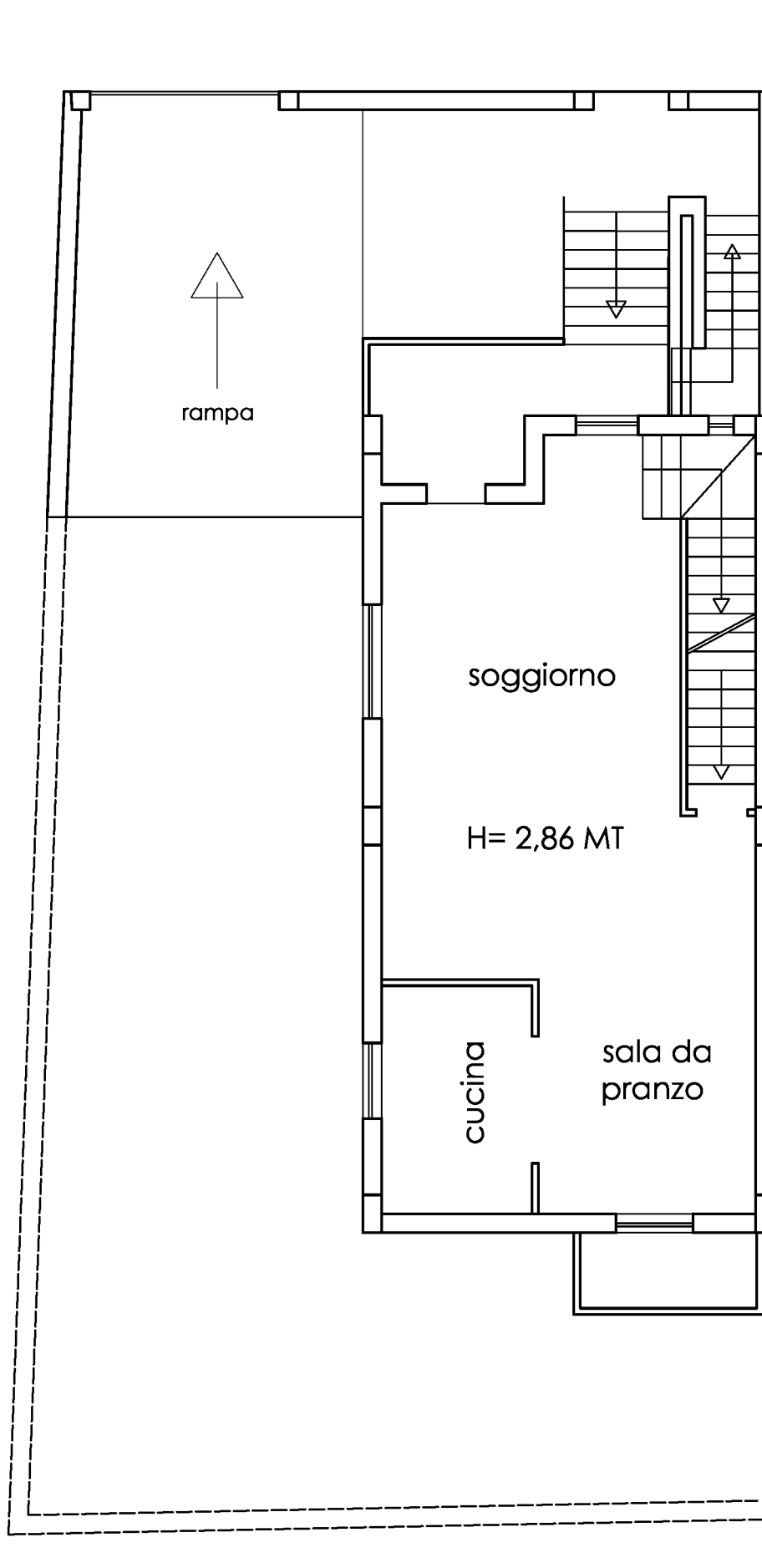

PLANIMETRIA RILEVATA QUOTATA

fg. 37, p.IIIa 1814, sub 1

scala 1:100

PIANO TERRA

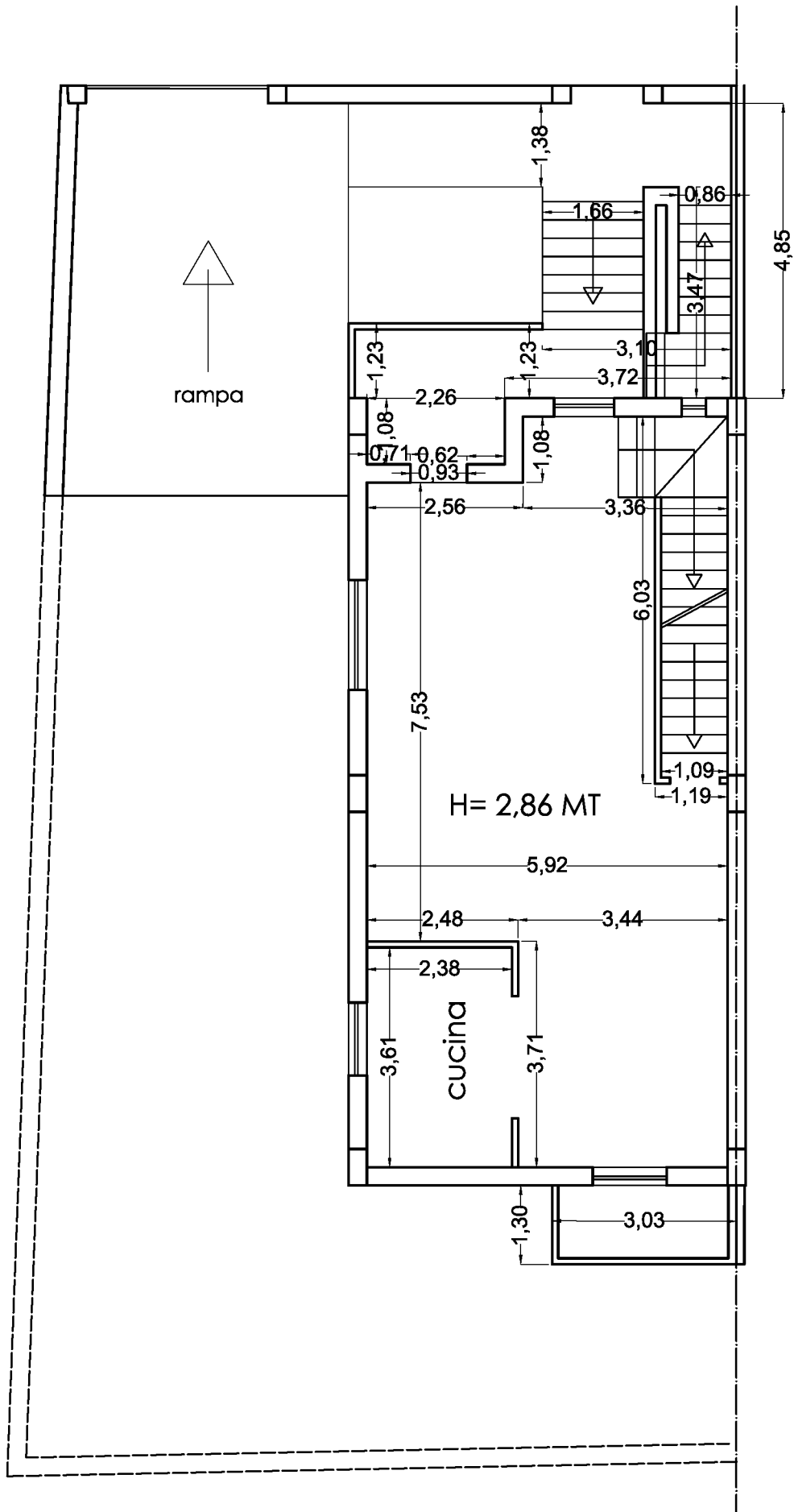

CALCOLO SUPERFICI RILEVATE

fig. 37, p.lla 1814, sub 1

scala 1:100

PIANO TERRA

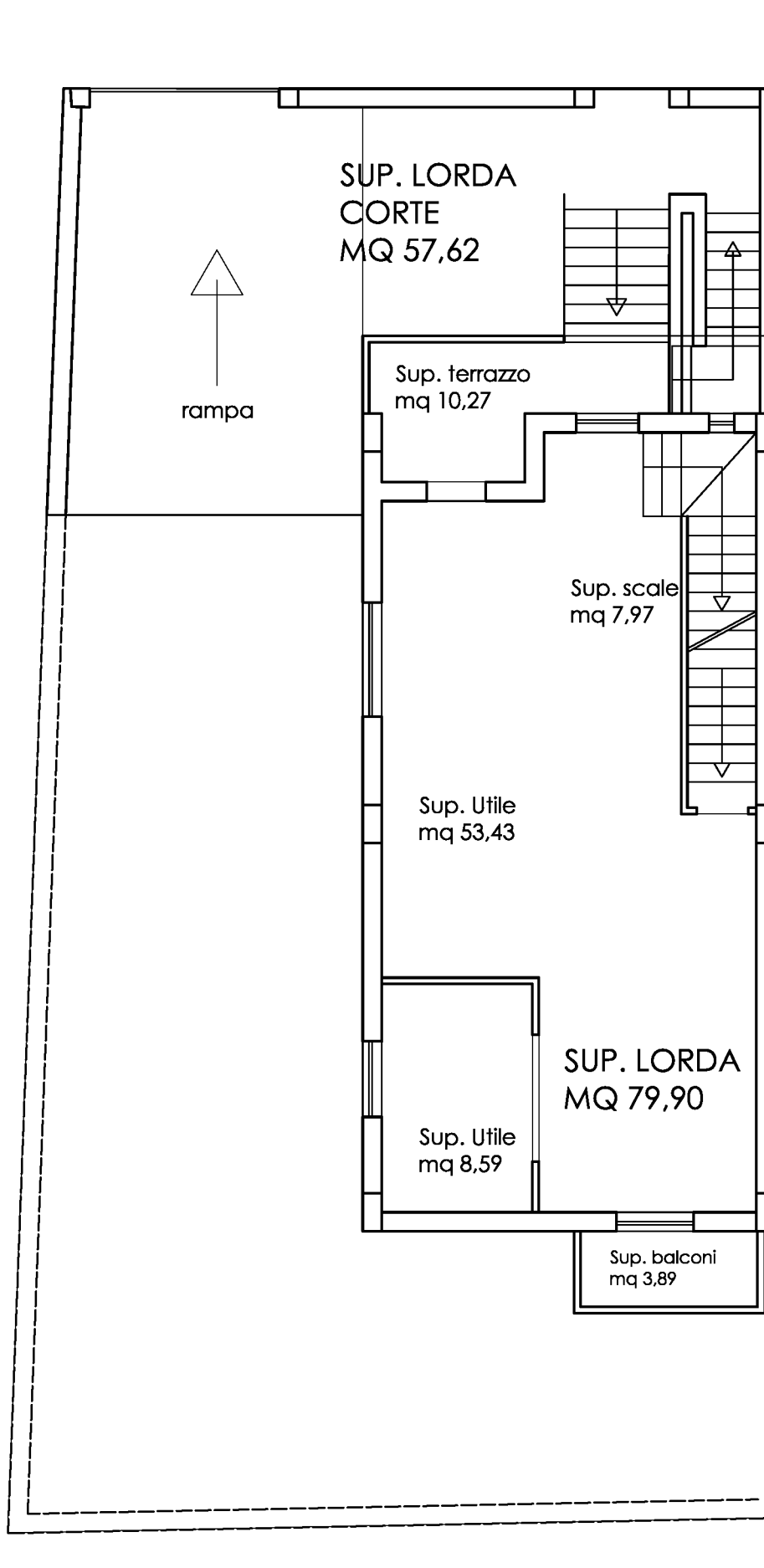

PLANIMETRIA CATASTALE

fig. 37, p.lla 1814, sub 1

scala 1:100

PIANO PRIMO

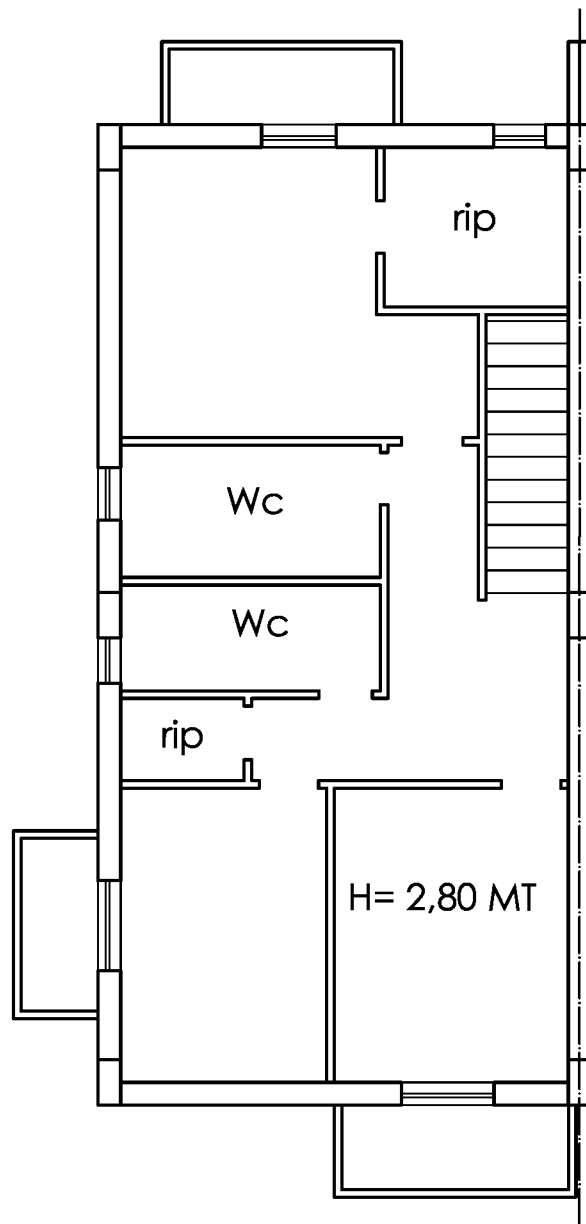

PLANIMETRIA CATASTALE QUOTATA
fig. 37, p.lla 1814, sub 1
scala 1:100 PIANO PRIMO

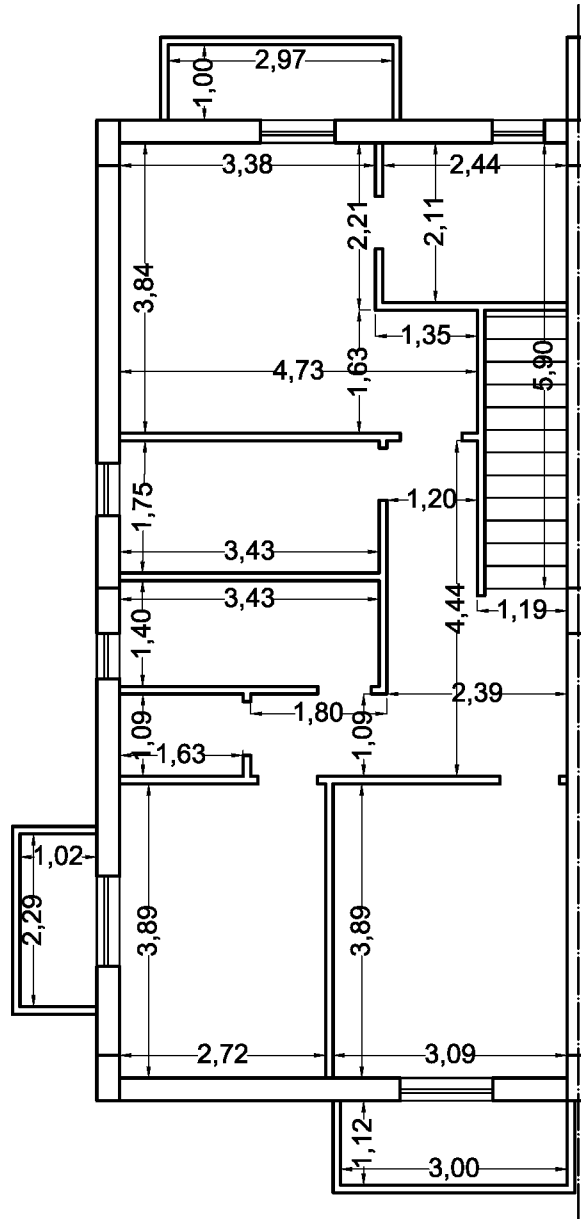

CALCOLO SUPERFICI CATASTALI

fg. 37, p.lla 1814, sub 1

scala 1:100

PIANO PRIMO

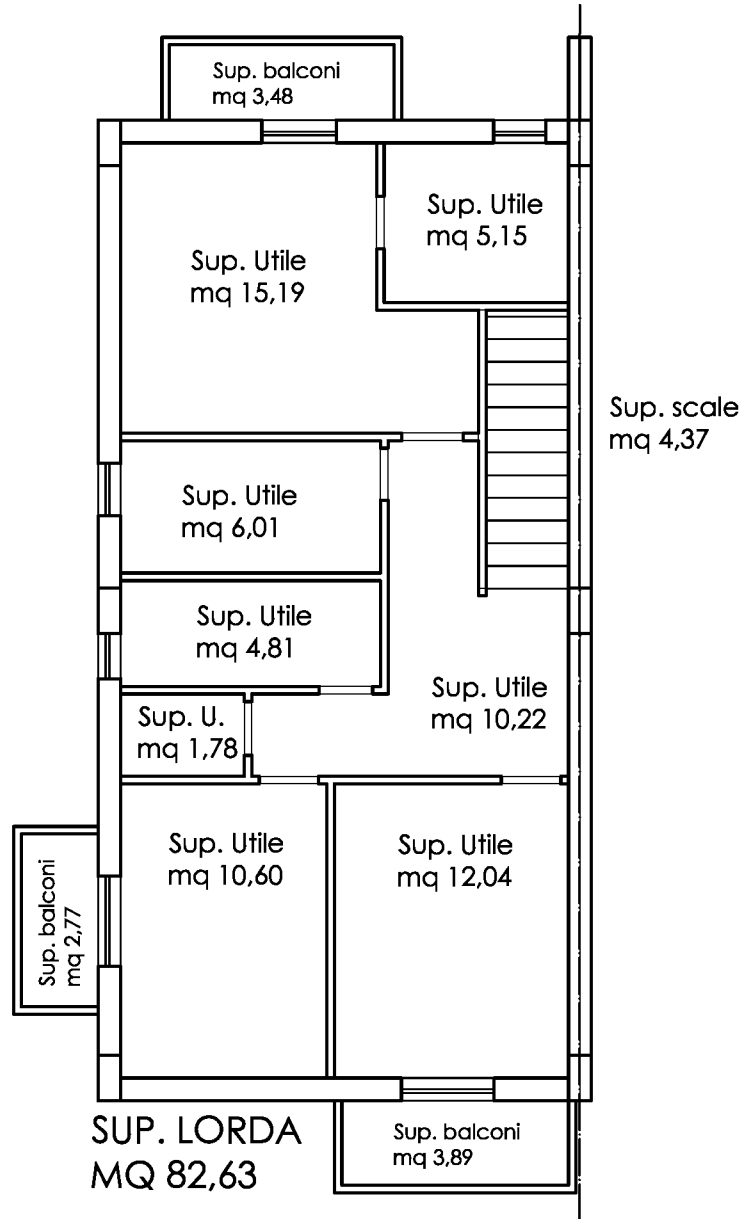

PLANIMETRIA DI PROGETTO

fig. 37, p.lla 1814, sub 1

scala 1:100

PIANO PRIMO

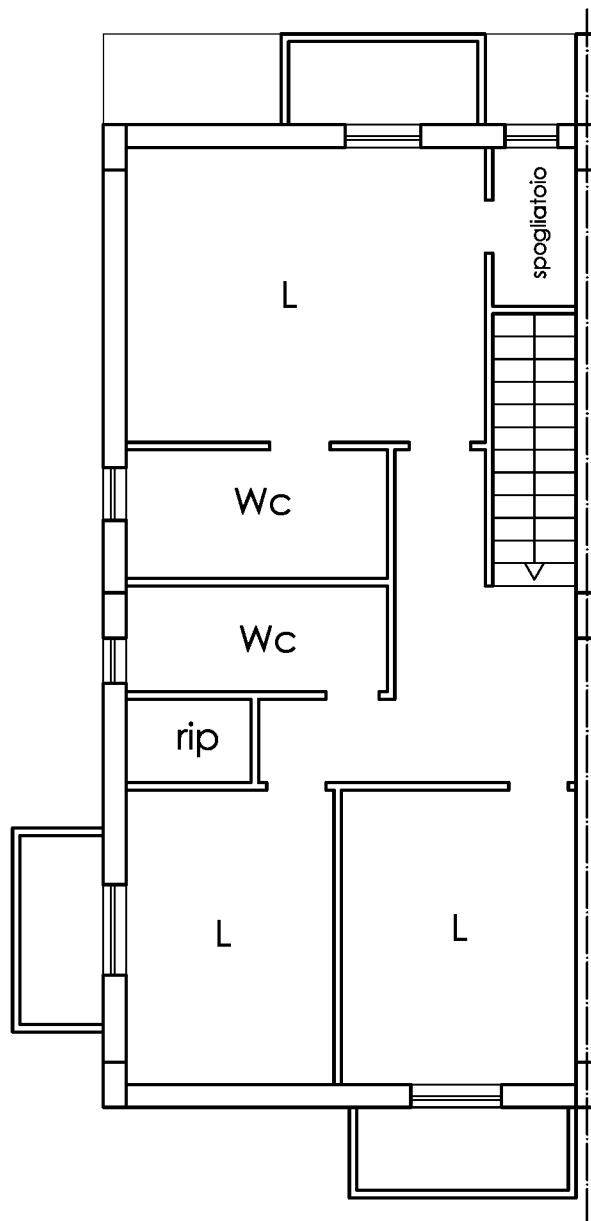

PLANIMETRIA DI PROGETTO QUOTATA
fig. 37, p.lla 1814, sub 1
scala 1:100

PIANO PRIMO

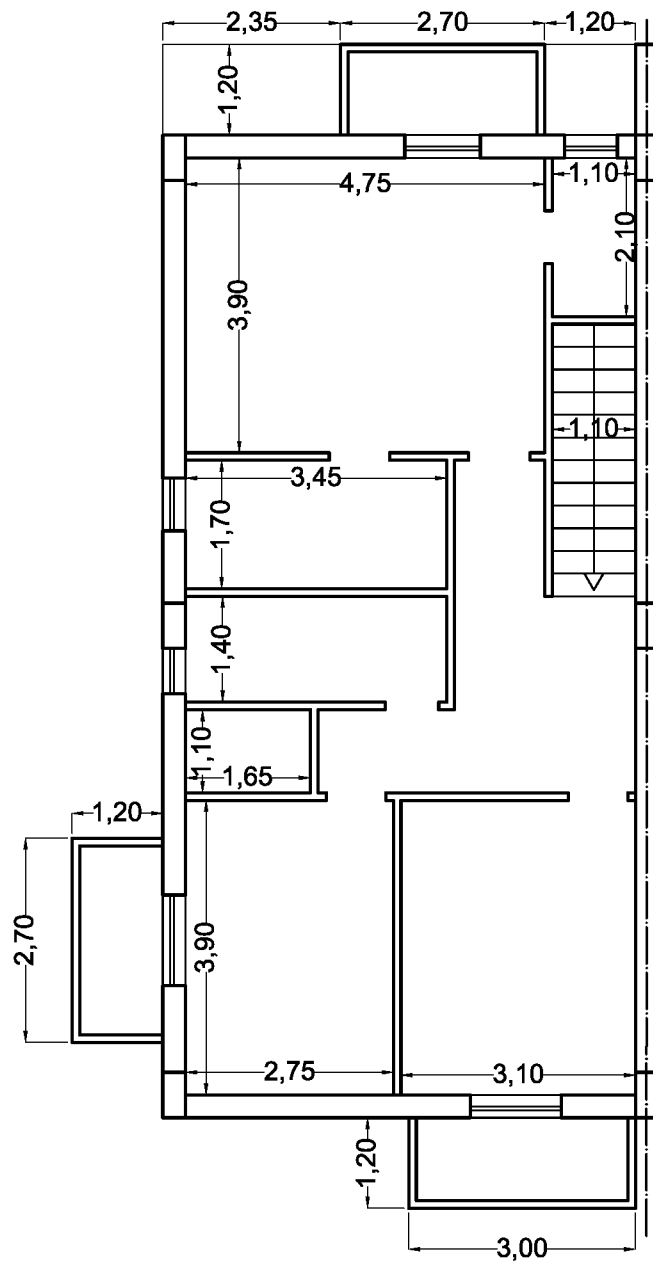

CALCOLO SUPERFICI DI PROGETTO

fig. 37, p.lla 1814, sub 1

scala 1:100

PIANO PRIMO

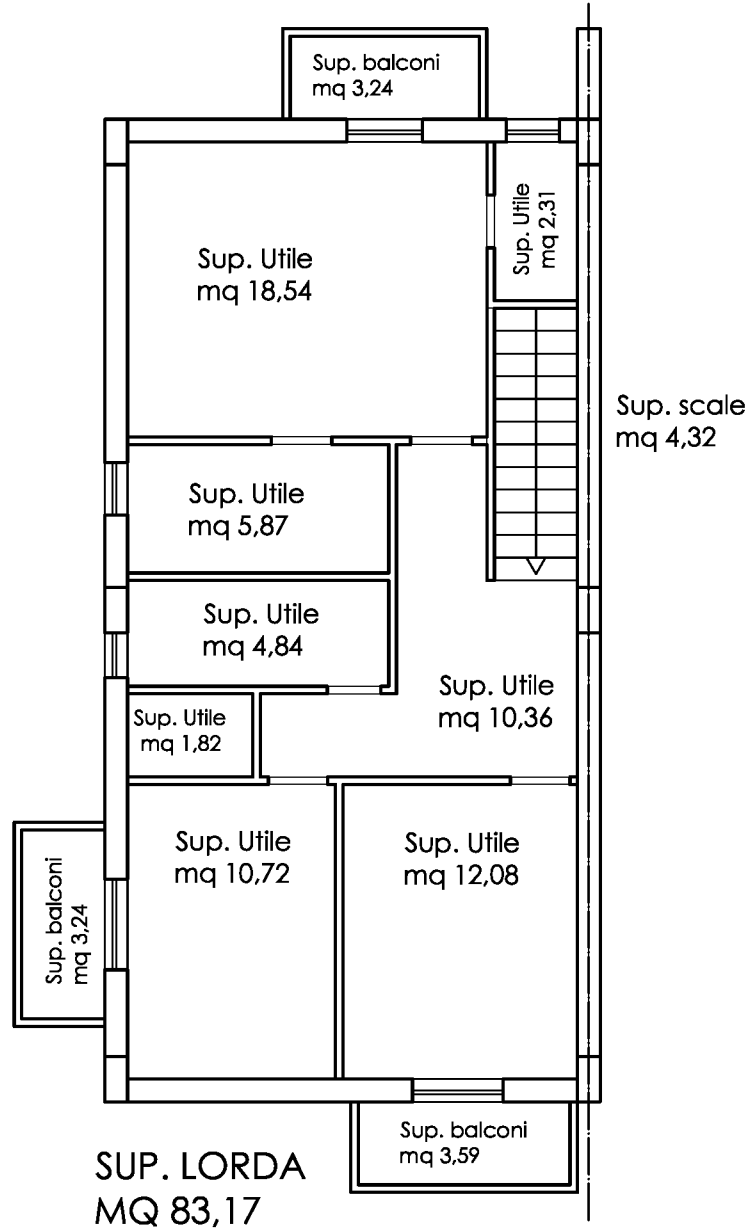

PLANIMETRIA RILEVATA

fg. 37, p.IIa 1814, sub 1

scala 1:100

PIANO PRIMO

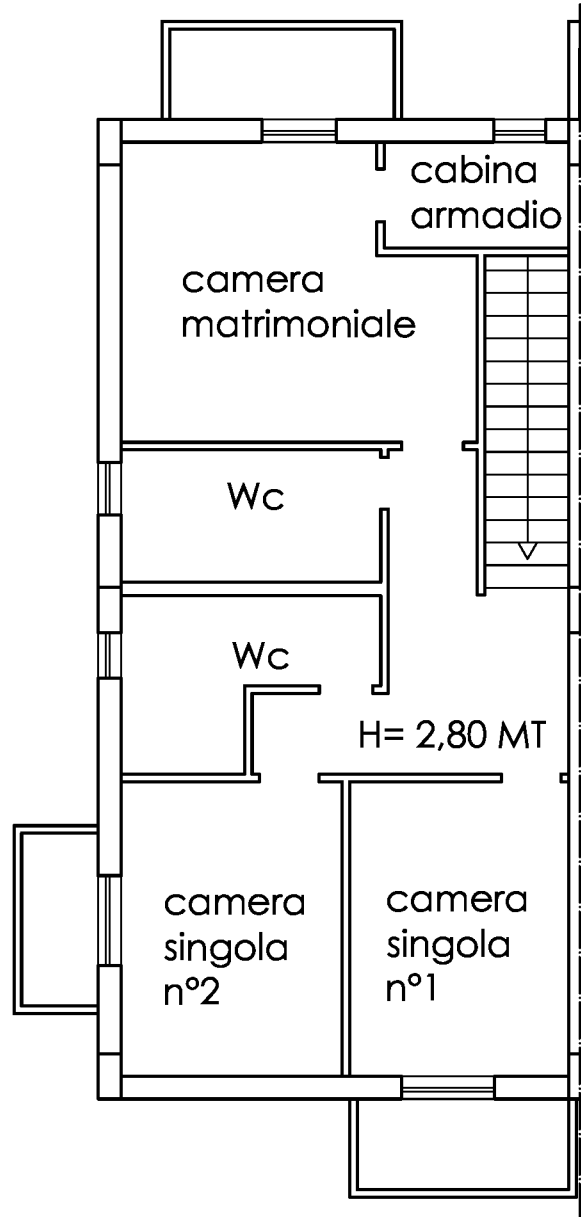

PLANIMETRIA RILEVATA QUOTATA

fg. 37, p.lla 1814, sub 1

scala 1:100

PIANO PRIMO

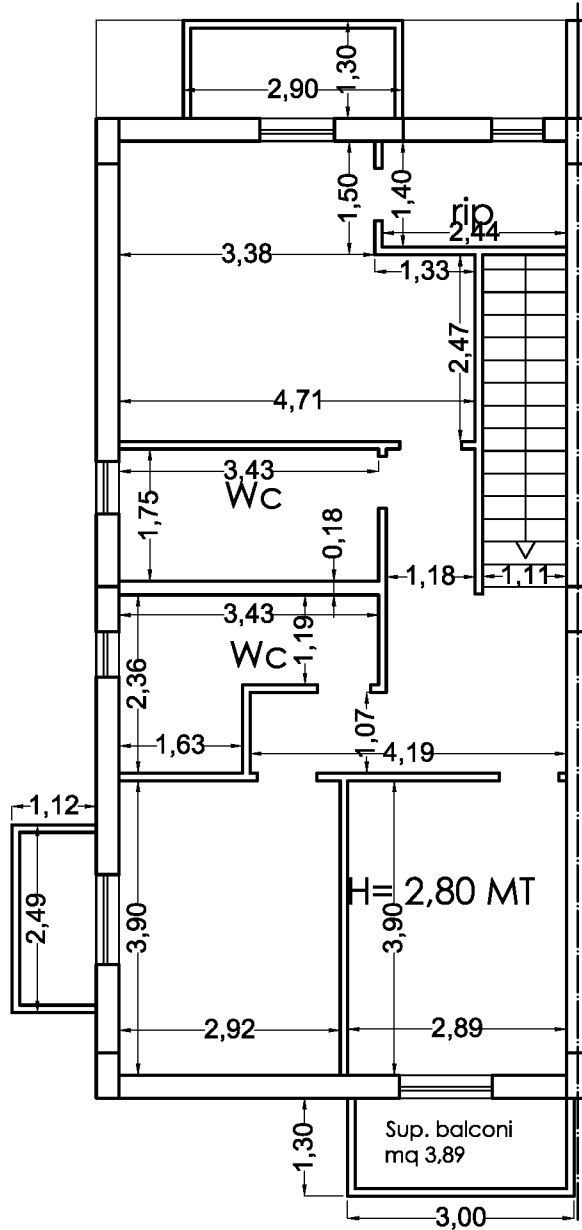

CALCOLO SUPERFICI RILEVATE

fg. 37, p.lla 1814, sub 1

scala 1:100

PIANO PRIMO

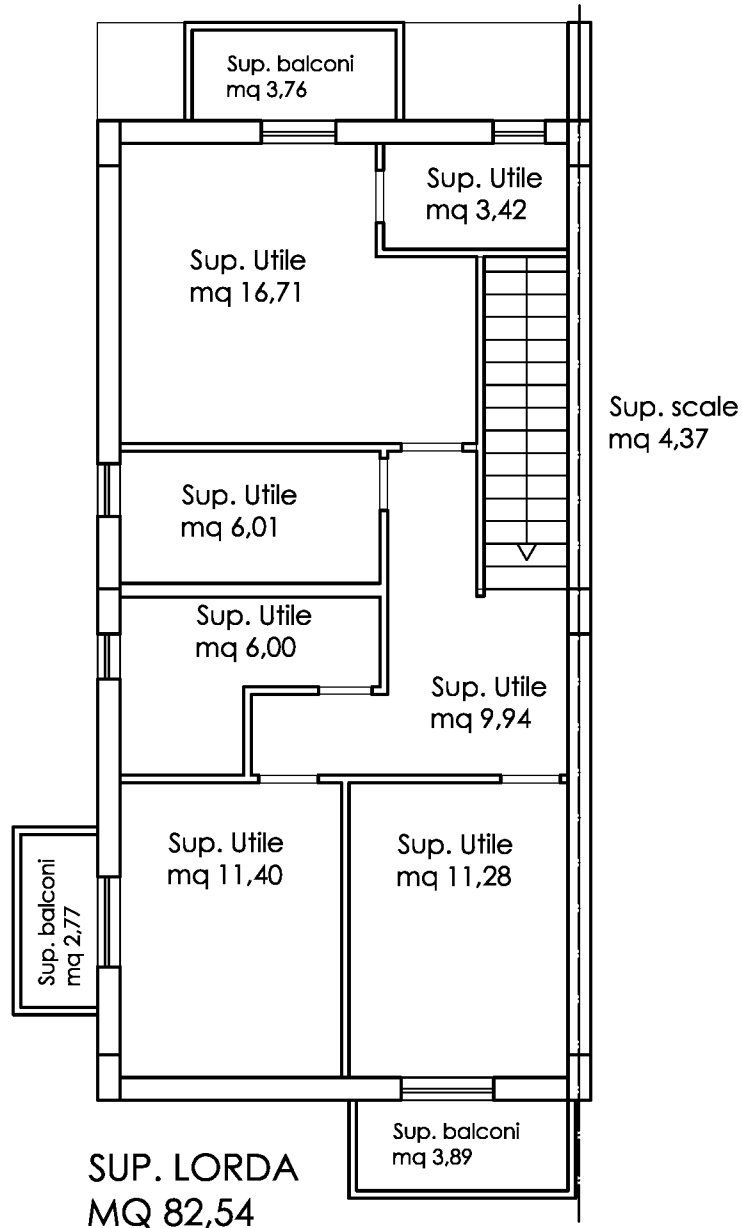

CONFRONTO SUPERFICI PIANO SEMINTERRATO

SUPERFICI CATASTALI

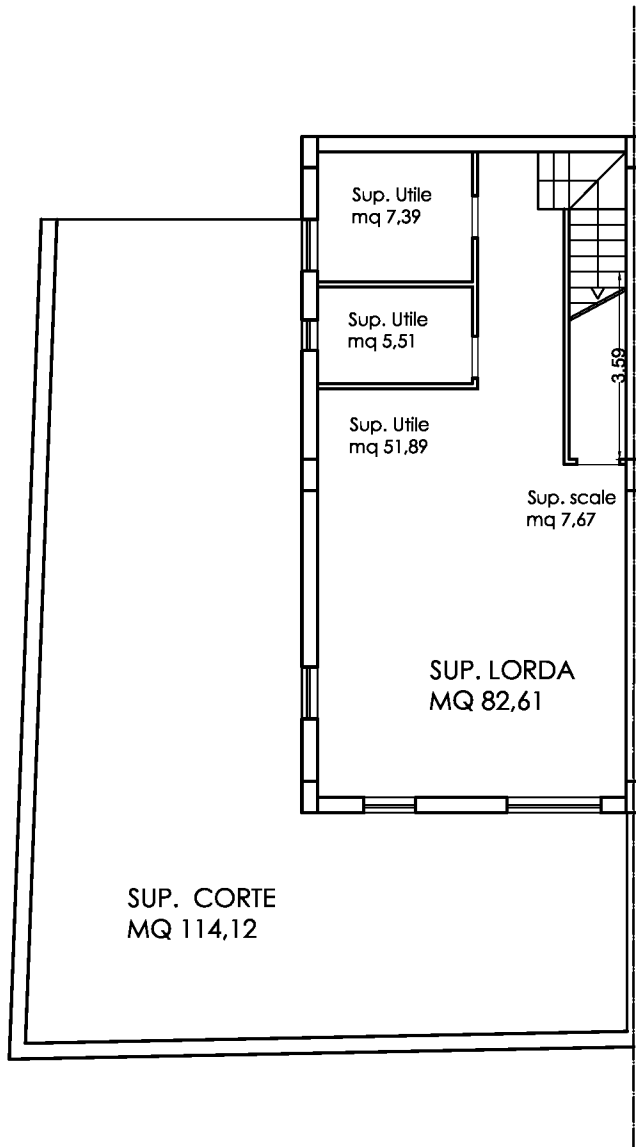

SUPERFICI DI PROGETTO

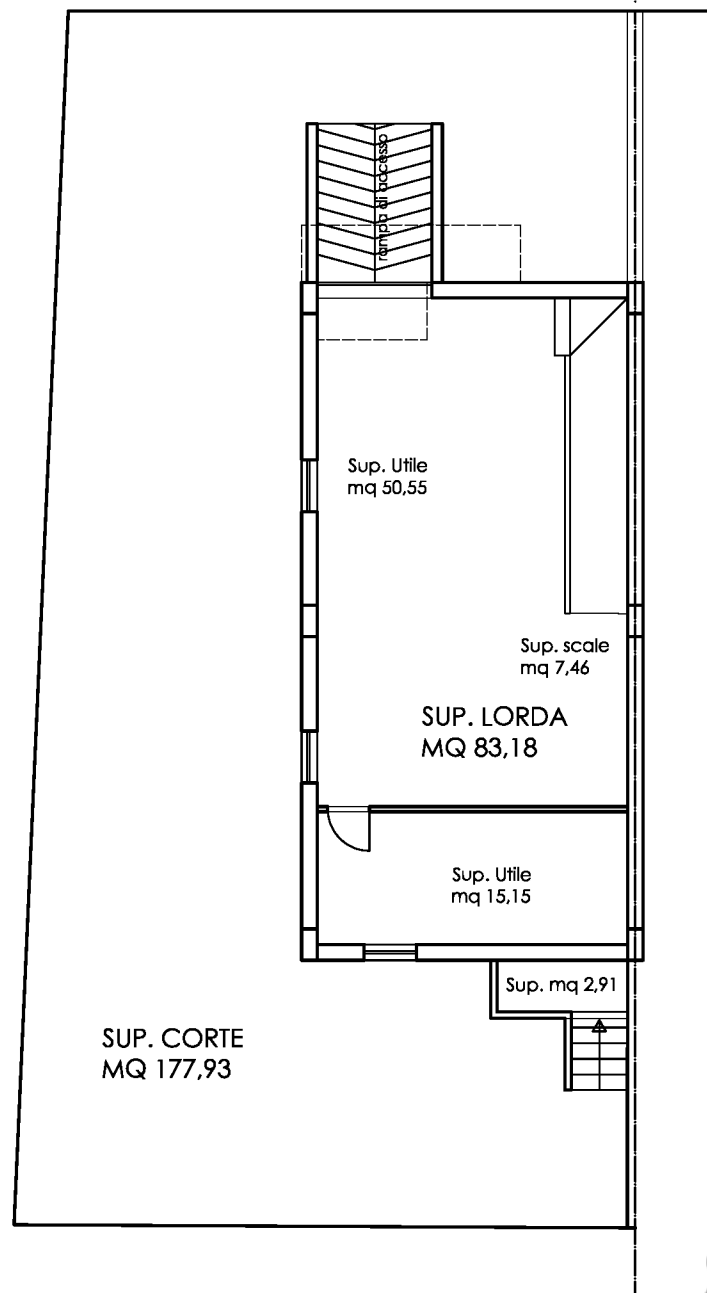

SUPERFICI RILEVATE

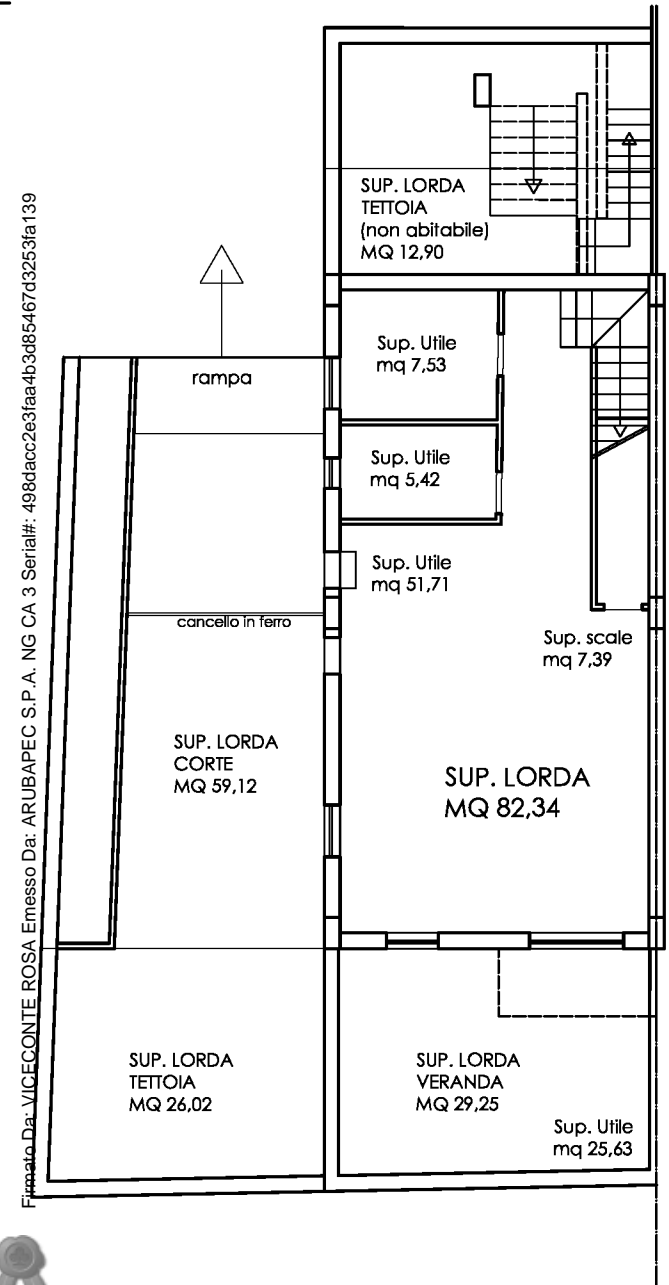

Firmato Da: VICECONTE ROSA Emesso Da: ARUBAPEC S.P.A. NG CA 3 Serial#: 4980acc2e3faa4b3d85467d3253fa139



CONFRONTO SUPERFICI PIANO TERRA

SUPERFICI CATASTALI

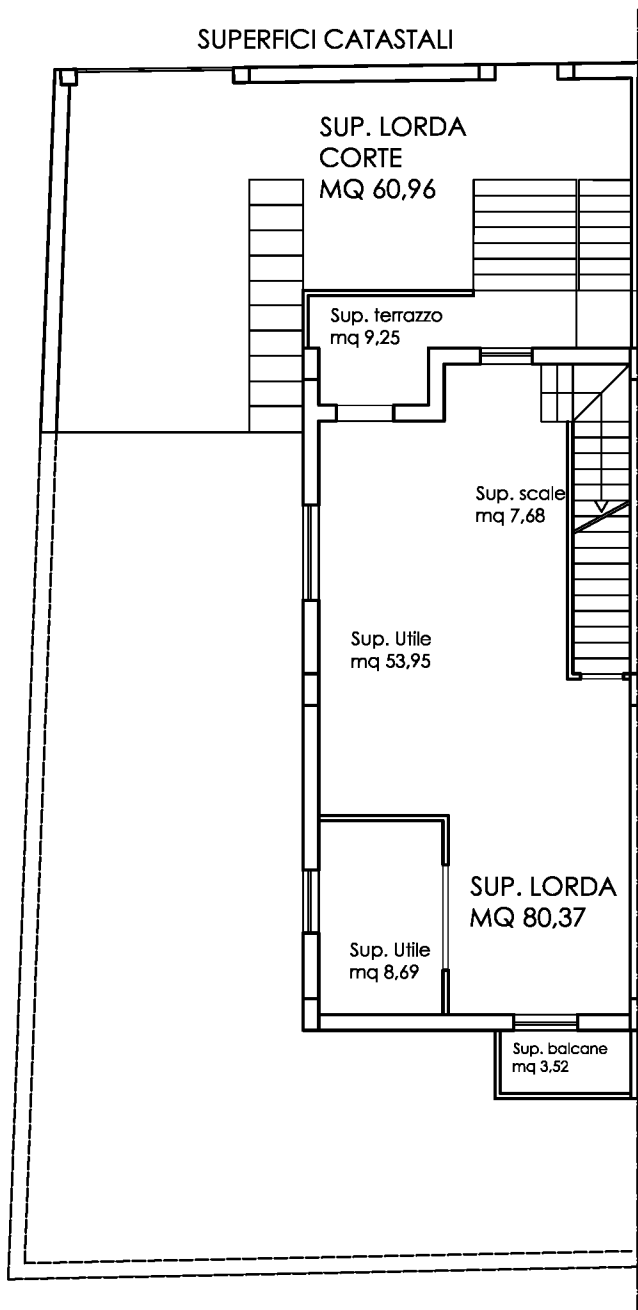

SUPERFICI DI PROGETTO

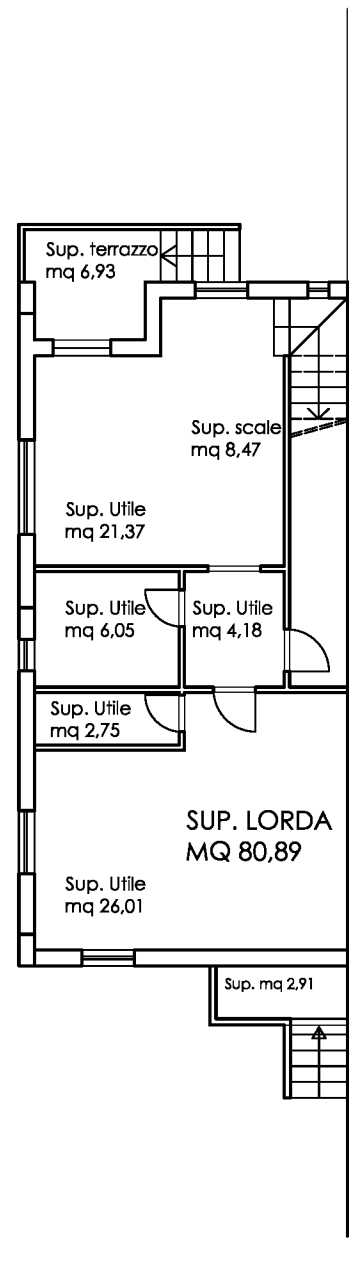

SUPERFICI RILEVATE

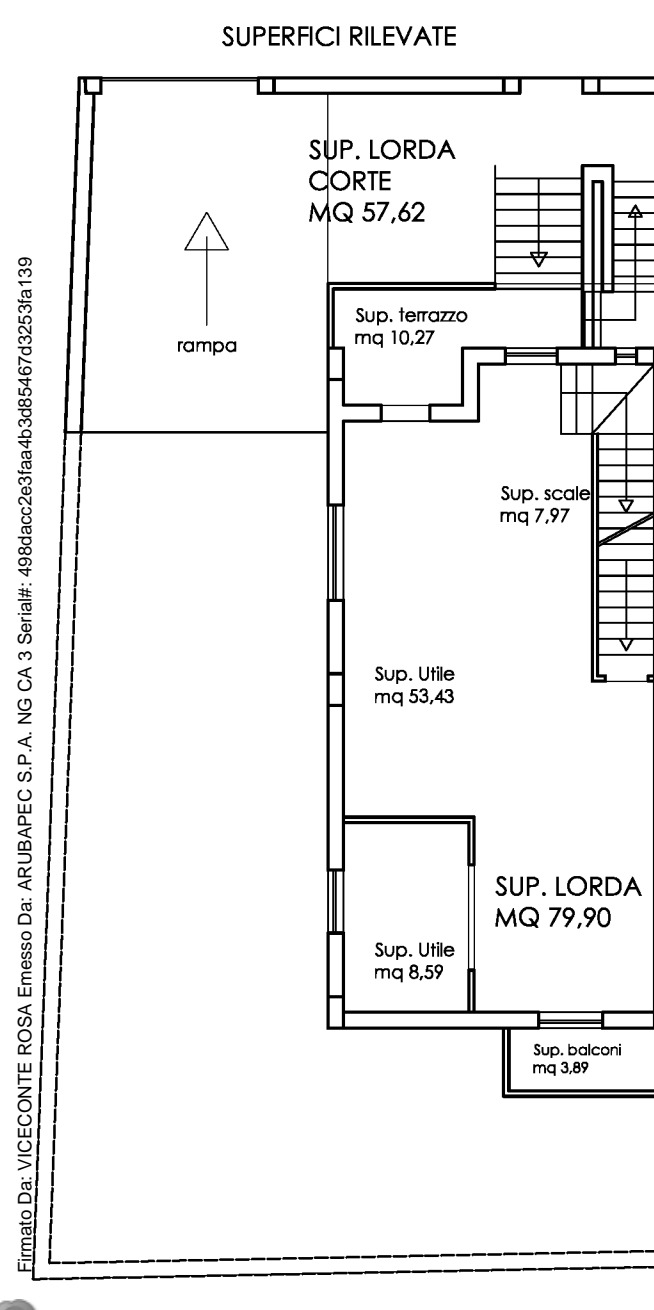

Firmato Da: VICECONTE ROSA Emesso Da: ARUBAPEC S.P.A. NG CA 3 Serial#: 4980acc2e3faa4b3d85467d3253fa139



CONFRONTO SUPERFICI PIANO PRIMO

SUPERFICI CATASTALI

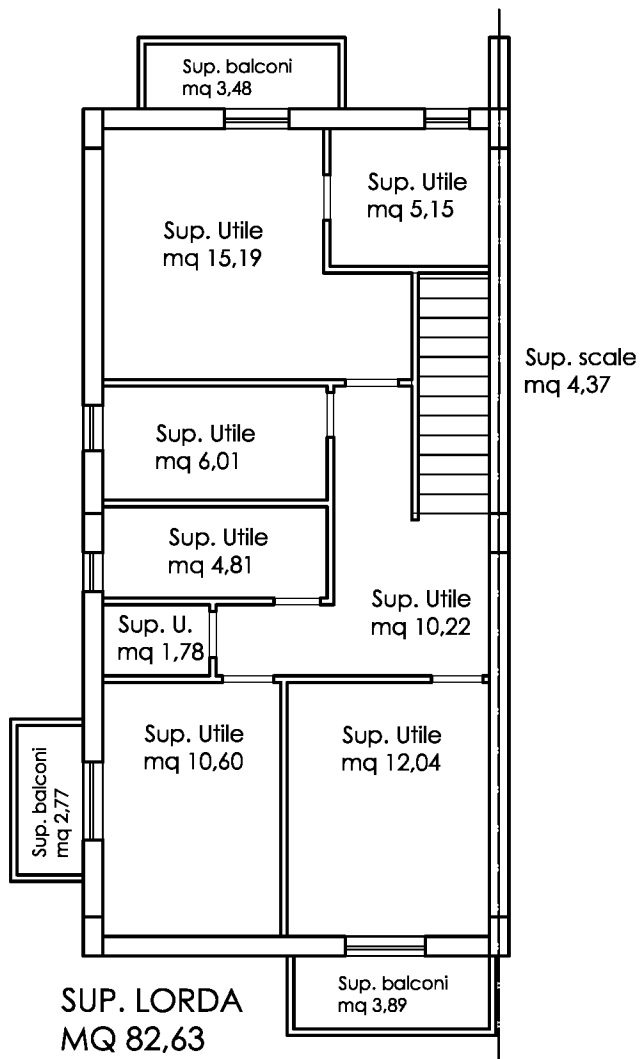

SUPERFICI DI PROGETTO

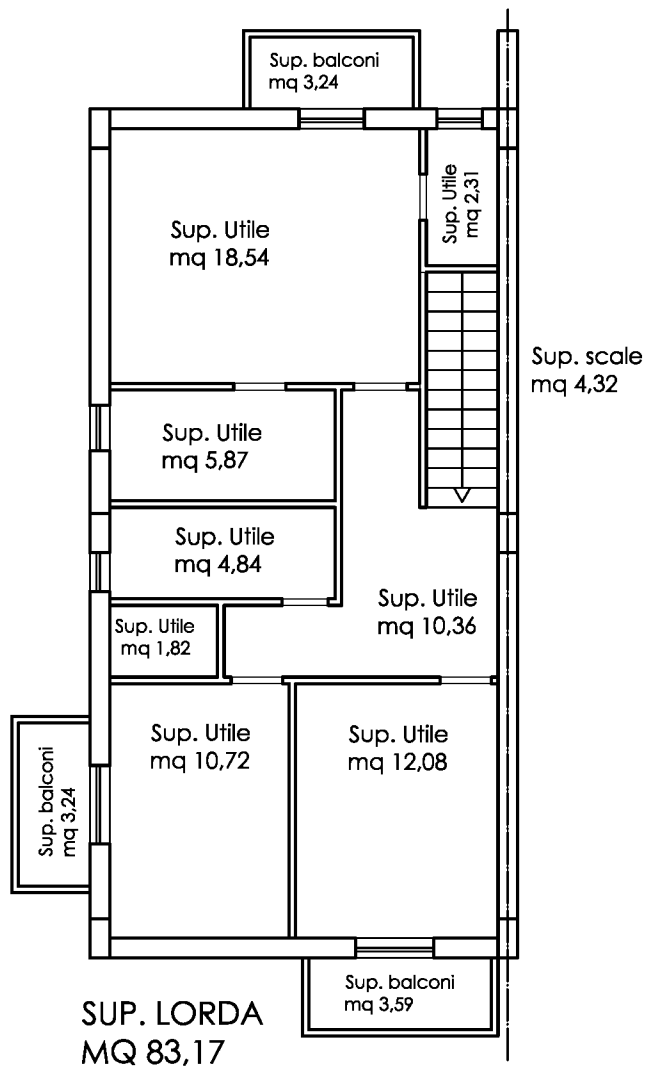

SUPERFICI RILEVATE

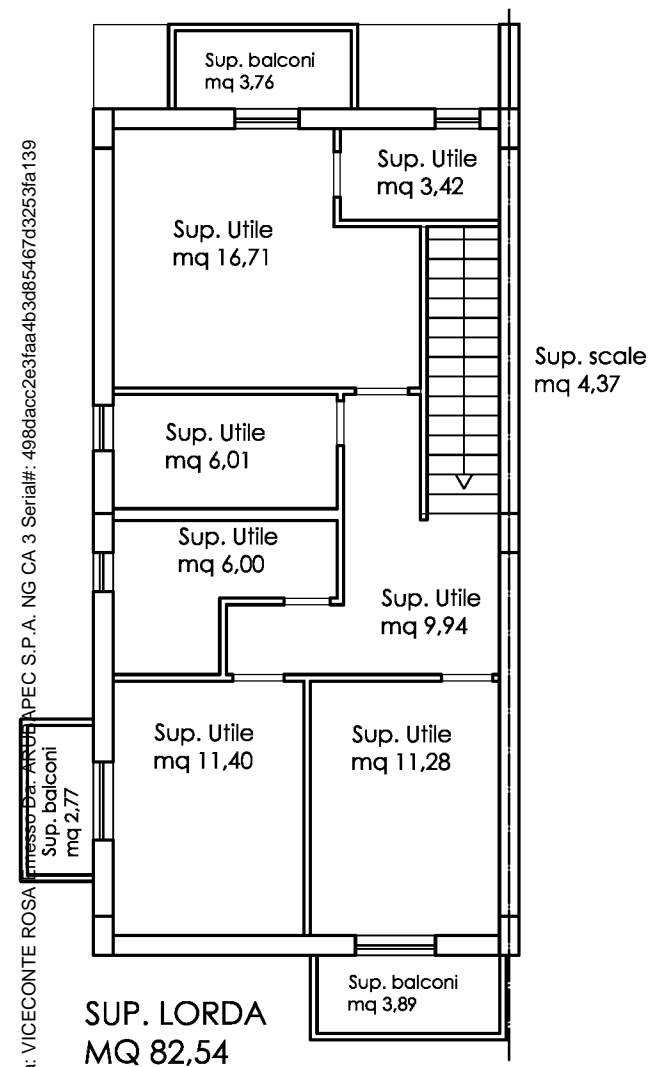

Firmato Da: VICECONTE ROSA
Messaggio Da: ARBORE
PEC S.P.A. NG CA 3 Serial#: 4980acc2e3faa4b3085467d3253fa139

